

KETS Technical Environment Overview

Last Reviewed: April 19, 2024

Last Updated: April 19, 2024

Active Directory	2
Internet Content Management System	6
Electronic Email and Collaboration	9
KETS Service Desk.....	16
District Financial System (Tyler Enterprise ERP, formerly MUNIS).....	20
The KEN Network (Kentucky Education Network)	24
Security	27
Kentucky Student Information System (Infinite Campus).....	31

The information contained within this overview is the current state for the respective Kentucky Educational Technology System (KETS) technical environments. Some environments refer to current or future project related work that may result in changes that impact the information contained within these documents. Where possible, that information is included. However, these documents are for high level planning purposes only.

The Kentucky Education Technology Systems (KETS) product and technology standards enable commonality and consistency among Kentucky's public school districts. These standards complement KETS initiatives and help ensure system supportability across all districts. While the technical environment described in this document follows these standards, the actual KETS Standards cover additional products and technologies, and new systems implemented at the state and district levels are expected to conform to these Standards where applicable. The KETS Standards can be found on the KDE website, currently at

<https://education.ky.gov/districts/tech/kpur/Pages/KETS%20Technology%20Standards%20and%20Purchasing.aspx>.

Department of Education
Office of Education Technology
Division of School Technology Planning and Project Management
300 Sower Blvd.
Frankfort, KY 40601
(502) 564-2020

KETS Technical Environment Information Document

Active Directory

Section 001

Last Reviewed: 12/6/2023

Last Updated: 12/6/2023

Prepared by John Logan

Department of Education

Office of Education Technology

Division of School Technology Planning and Project Management

300 Sower Blvd.

Frankfort, KY 40601

(502) 564-2020

Summary

The KETS Active Directory provides authorization and authentication services for nearly 1,000,000 user objects and 500,000 computers and servers. It provides a directory structure for easier management of the user and computer objects throughout the KETS environment. Microsoft Active Directory services provide DHCP, DNS, WINS, Group Policies for object management, as well as normal directory services like authentication and authorization. There are also dependencies with our collaboration tools (Office 365 for Education and Google Workspace for Education) regarding account provisioning and password sync. Please visit Section 5 'Electronic Email and Collaboration' for more information.

Visual Representation

This is a diagram of the KETS Active Directory structure. The green circles represent AD Sites for replication and the orange circles designate domains. One of the two district-located DCs is also a Global Catalog server. Though there are only three domains shown these represent 178 domains, and one empty root domain (179 total AD Domains). All Active Directory Domain Controllers are virtualized with the exception of the two root domain controllers located in Frankfort (GC/DC).

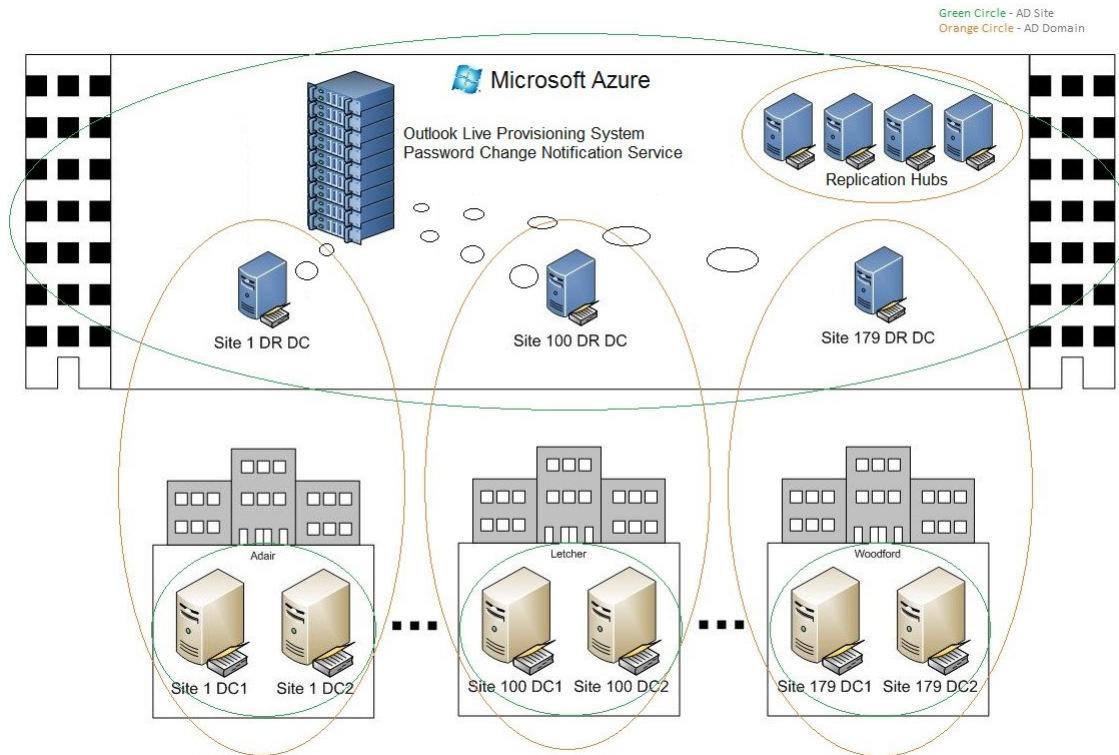

Description

The KETS Active Directory is a mixed mode Windows Server single forest with 180 domains, averaging 3,500 users per domain. All domain controllers are running Windows Server. The smallest domain has approximately 500 users while the largest has nearly 125,000. The forest consists of a root domain, one domain each for the Department of Education, KY School for the Deaf (KSD), KY School for the Blind (KSB), a research and development domain as well as one domain for each of our 171 school districts. There are also three additional domains that are used for piloting updates. Each domain has a minimum of three domain controllers with one acting as a global catalog server. One DC for each domain is located in Microsoft Azure 'in the cloud'. This provides off-site redundancy from a district perspective. Generally, each district is also a single site within the directory structure. Replication within the forest is a hub and spoke model with replication hub servers hosted in Microsoft Azure and site links created between each domain and the hub site. AT&T's Netbond VPN solution as well as Microsoft ExpressRoute allow for a reliable network connection between the KETS on premise network and the cloud subnet (*NOTE-Our Internet network provider is currently being transitioned from AT&T to ENA. As this migration occurs through the first half of 2024 district connections will be moved from AT&T's Netbond to ENA's connection to Azure IAAS*).

Windows Server DNS provide naming services throughout the internal network. WINS is only enabled in a few districts. DHCP provides IP addresses to workstations while servers use static addressing.

Organizational units have been created within each district, named 'Students', 'Staff', 'Leadership', 'Workstations', and 'Local Servers'. These top-level organizational units cannot be deleted or have their permissions modified. Key district technical staff have been delegated permissions to create/modify child organizational units for each school in the district as prescribed in the KETS OU Naming Standards document (available upon request).

Identity extends to Office 365 for Education and Google Workspace for Education

Azure Active Directory Sync (AAD Sync) is configured for each school district, provisioning users and groups from on-prem Active Directory to each district's Office 365 tenant. These AAD Sync services are supported by KDE/OET. For those districts who have purchased Microsoft Entra ID Premium v1 they also have their passwords written back from O365 to on-prem AD, allowing for O365 Self Service Password Reset to be utilized. (*NOTE-Two of our districts, Jefferson County and Owensboro Independent, have another solution provisioning accounts from AD to O365 so the AADC for these two are not syncing accounts from AD*)

Google Cloud Directory Sync (GCDS) is configured for some districts that choose to provision users and groups from on-prem Active Directory to their Google for Education tenant. This is supported by the school districts. There are some of these districts that also choose to have their passwords synchronized from on-prem AD provision to Google.

For those districts OET has installed Google App Password Sync (GAPS) on the district AD Domain Controllers. This is supported by KDE/OET.

Management and Support Strategy

The KETS Active Directory is monitored using Microsoft System Center Operations Manager. The KETS Messaging and Directory Services Team and the other operation service teams provide management of sites, site links, replication, domain controllers' hardware, and all naming services. The KETS Messaging and Directory Services Team manages all infrastructure and enterprise functions of Active Directory. District technical staff manage user account creation/modification, computer account creation/modification, and some group policy creation/modification within specified organizational units. Permissions have been delegated to a named group within each domain for these functions. When districts have issues, they have the ability to call a technical service desk employed by KDE. Some issues are escalated to the KETS Messaging and Directory Service Team and potentially on to Microsoft through a Premier Support engagement.

Future Plans

We are investigating the potential of moving away from Active Directory in the coming years, or at a minimum greatly reducing our footprint. Current plan would be to do so by the end of 2027. Some services we would continue to be provided to school districts by KDE while other will either be deprecated or moved to another service of district's choosing and management.

KETS Technical Environment Information Document

Internet Content Management System

(Previously: Application and Content Caching)

Section 002

Last Reviewed: 4/19/2024

Last Updated: 4/19/2024

Prepared By: Paul Shoemaker

Department of Education

Office of Education Technology

Division of School Technology Planning and Project Management

300 Sower Blvd.

Frankfort, KY 40601

(502) 564-2020

Summary

This document describes the design and use of Internet Content Management Systems within the KETS or Kentucky Education Technology Systems network and within the districts.

Visual Representation

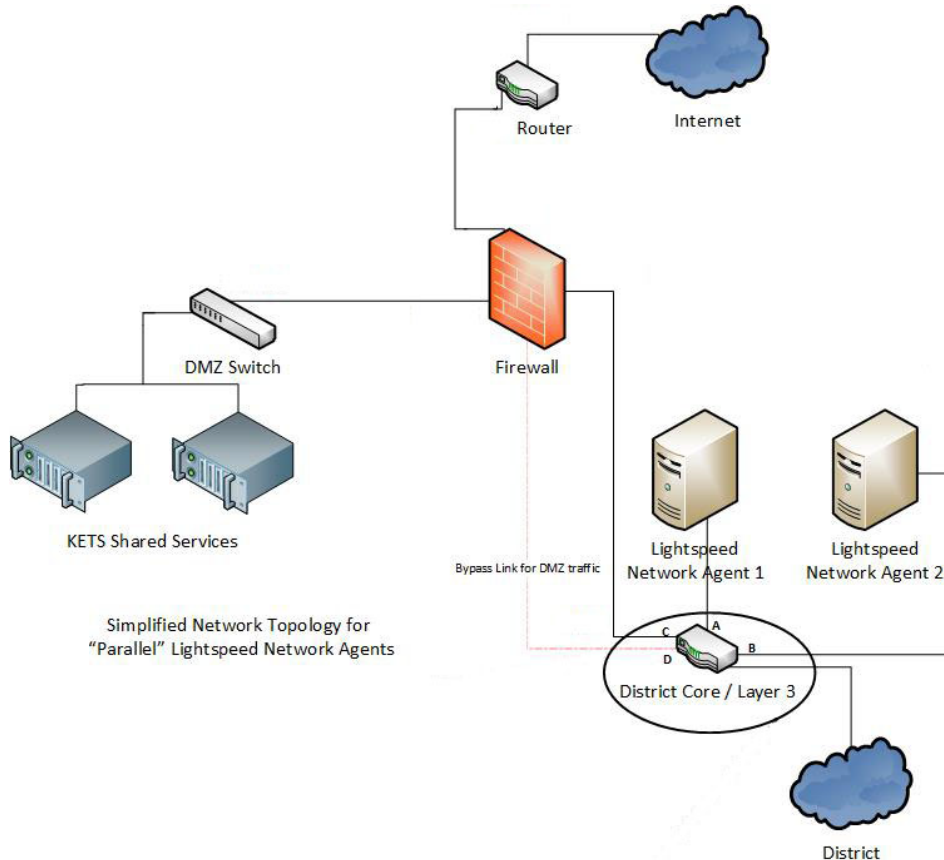

Description

The Kentucky Educational Technology System (KETS) utilizes an MPLS connection to the Internet. The districts and KDE the Agency have independent connectivity to the Internet through the MPLS cloud. KDE the Agency, as well as each school district, has their own independent Internet Management System based on the Lightspeed Relay product. Access and tracking are based on Active Directory authentication, IP addressing or client installation on the end-user system. This is a combination solution consisting of the Lightspeed Relay Smart Client used on district owned end user devices and the Network Agent used for all on premise devices not owned by districts (BYOD) or devices that cannot use the Relay Smart Agent software. Both solutions filter all Internet bound traffic that pass through the Lightspeed Relay Smart Agent or Network Agent systems. The Lightspeed Relay Smart Agents and Network Agents are managed by the same

administration console and policy sets and configurations are distributed to both systems. The Network Agent architecture is based on DNS requests to determine filtering policy application. The Network Agents are “Relay Aware” and do not filter devices that have the Relay Smart Agent installed.

Districts are allowed to request a waiver from the Lightspeed product and select their own Internet filtration device, so long as it meets the requirements documented in KAR 701-5:120, CIPA and other regulatory guidelines or statutes. A baseline configuration is provided to all districts that may be used as a guide with the Lightspeed system. Districts may alter that configuration to reflect any additional policies or restrictions they practice. Districts may employ a caching solution at their discretion.

Management Strategy

The Office of Educational Technology (OET) provides the Lightspeed solution and a baseline configuration for all districts. Lightspeed provides direct support for this product for districts and KDE. Each district is responsible for their maintenance and configurations beyond the baseline provided. If a district has requested a waiver for a different product, the district is responsible for all support and configurations and is expected to arrange for support from the providing vendor.

Future Plans

Due to procurement cycles, it is unclear what system KETS will be using for Internet Content Management past fall 2024.

KETS Technical Environment Information Document

Electronic Email and Collaboration

Section 003

Last Reviewed: 12/6/2023

Last Updated: 12/6/2023

Prepared by John Logan

Department of Education

Office of Education Technology

Division of School Technology Planning and Project Management

300 Sower Blvd.

Frankfort, KY 40601

(502) 564-2020

Summary

This document describes the electronic messaging and collaboration applications used by the Kentucky Department of Education, KSB, KSD, and the 171 Kentucky school districts. This comprises nearly 900,000 user mailboxes (faculty, staff and students).

These solutions are 'cloud-based' as backend systems that deliver these environments are maintained by the respective companies (Microsoft and Google). All districts and KDE have both a Office 365 and Google Workspace for Education system. Each district/KDE choose where their users will use e-mail service specifically, but all other services are enabled for users (cloud drives, web conferencing, document sharing, etc). Users can choose which they want to use, but e-mail is enabled only for one of the systems for the entire districts or KDE.

The Office of Education Technology manages the provisioning technologies to provision accounts to the Microsoft Office 365 environments. Districts/KDE manage provisioning to its own Google Workspace for Education environment. Districts and KDE maintain and manage their respective communications environment.

The provisioning of accounts (users, groups, etc.) is accomplished by Microsoft's Azure Active Directory Connector of Office 365 and Google Cloud Directory Sync for Google Workspace for Education. Both of these provisioning tools pull information from one Microsoft Active Directory environment. For a deeper understanding of our Active Directory environment, you can go to that section in this document. *(NOTE-As mentioned in the Active Directory section we have two districts, Jefferson County and Owensboro Independent, that are provisioning mailboxes with another tool that replaces both Azure Active Directory Connect to O365 and Google Cloud Directory Sync to Google Workspace for Education)*

Visual Representation

Office 365 Provisioning

Visual representation Microsoft's provisioning topology as it pertains to Office 365

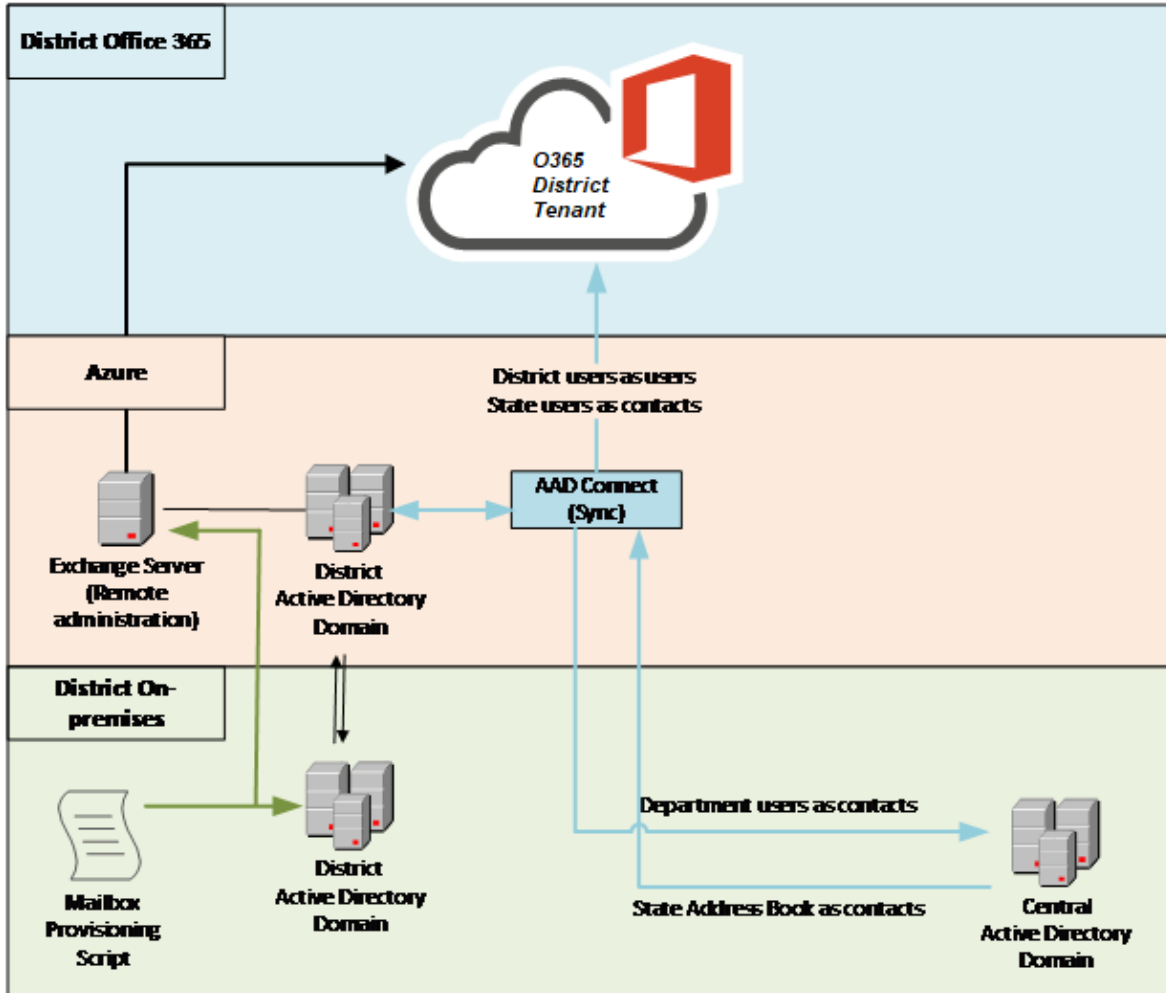

View of the provisioning infrastructure between Active Directory and Office 365. This allows us to utilize Active Directory for user management instead of using Office 365 directly for account creations, etc.

SMTP Relay

There are 2 x Windows 2019 Servers running IIS configured to forward SMTP email from allowed KETS devices (in districts and KDE). This is for devices that do not have the builtin ability to send email. By default all email sent through the relay goes out a single outbound connector, For those districts that wish to do DKIM Signing a dedicated connector is configured to their O365 or G Suite tenant where they can configure DKIM and then forward the mail.

Google Workspace for Education Provisioning

Visual representation Google's provisioning technologies as they pertain to Google Workspace for Education

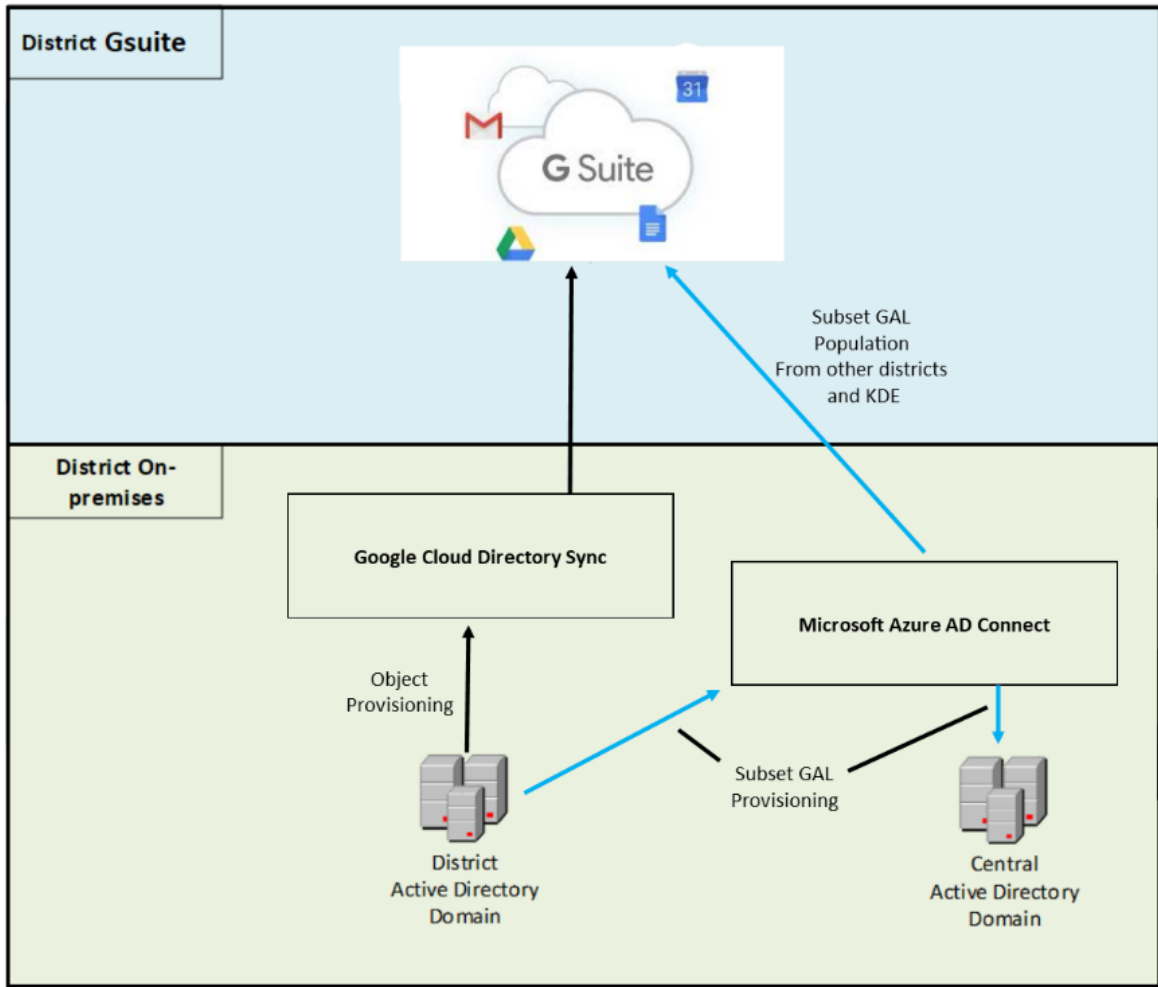

Subset GAL

Visual representation how our 'Subset GAL' works

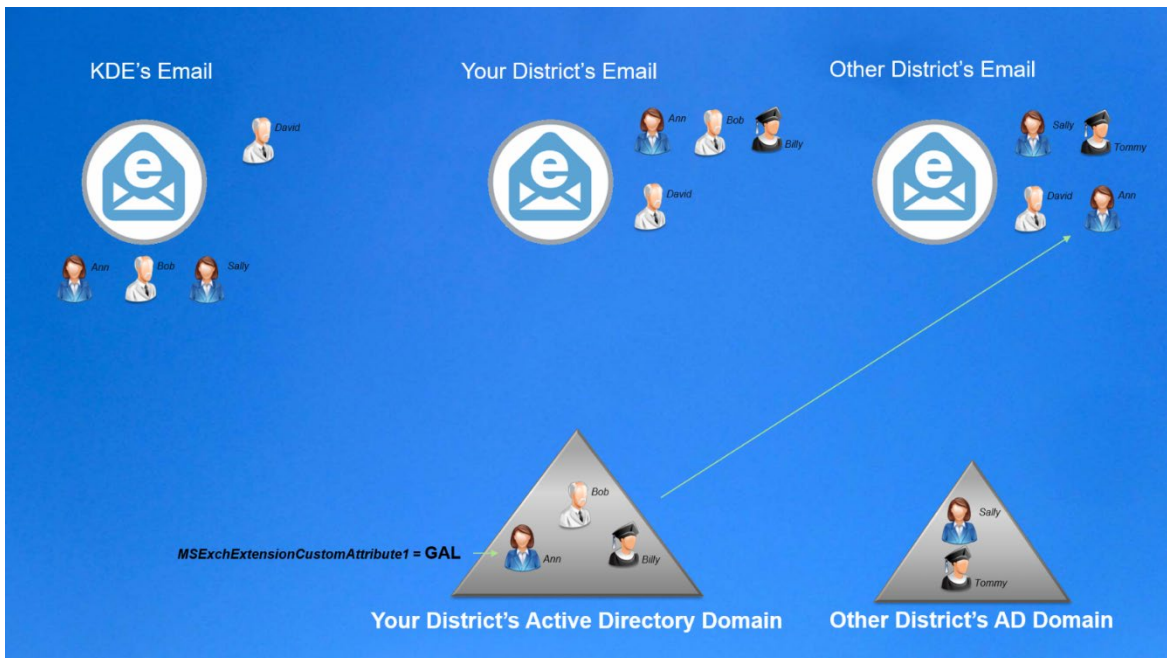

All adults in all districts show in KDE's Email Global Address list, and are also available to add to permissions of other Office 365 services (Sharepoint sites, OneDrive). Districts can add a value of GAL to a special attribute in Active Directory which will result in that user showing as a contact in all other district's email Global Address List, for both Office 365 and Google Workspace email systems.

Description

The Office 365 solution is Microsoft's cloud collaboration offering provided out of Microsoft's datacenters. It is comprised of the following:

- Exchange Online – Microsoft's electronic messaging solution.
- Teams for Business / Teams – Microsoft's web-conferencing solution.
- SharePoint Online – Microsoft's organization solution for securely storing, organizing, sharing and accessing your information.
- OneDrive Online – Microsoft's individual solution for securely storing, organizing, sharing and accessing your information.
- Office 365 Online suite. This allows users to install and update the Office suite of tools on up to five devices from the Internet.

The Google Workspace for Education solution is Google's cloud collaboration offering provided out of Google's datacenters. It is comprised of the following:

- Gmail – Google's electronic messaging solution.
- Google Meet – Google's web-conferencing solution.
- Google Drive – Google's individual solution for securely storing, organizing, sharing and accessing your information (Google doesn't have a like-product to Microsoft's SharePoint)
- Google Docs – Used to create and collaborate on online documents. Edit together with secure sharing in real-time and from any device
- Google Forms – Used to create online forms and surveys with multiple question types. Analyze results in real-time and from any device.

Management Strategy

The KETS Messaging and Directory Services Team centrally manages the Active Directory and provisioning solution responsible for CRUD (creates, updates, deletes) between AD and Office 365. Districts manage those solutions for the Google environment. The backend infrastructures themselves are managed by Microsoft and Google respectively. When districts have issues they have the ability to call a technical service desk employed by KDE. Some issues are escalated to the KETS Messaging and Directory Service Team while many, depending on the issue, will be directed directly to Microsoft and/or Google or their support providers.

Future Plans

We will be implementing an enterprise identity and provisioning system which might replace the AADC and GCDS functionalities. This new system will be implemented 2024/25.

KETS Technical Environment Information Document

KETS Service Desk

Section 004

Last Reviewed: 1/8/2024

Last Updated: 2/7/2023

Prepared by Dan Gorman

Department of Education

Office of Education Technology

Division of School Technology Planning and Project Management

300 Sower Blvd.

Frankfort, KY 40601

(502) 564-2020

Summary

This document provides an overview of the KETS Service Desk Services provided by the Office of Educational Technology.

Visual Representation

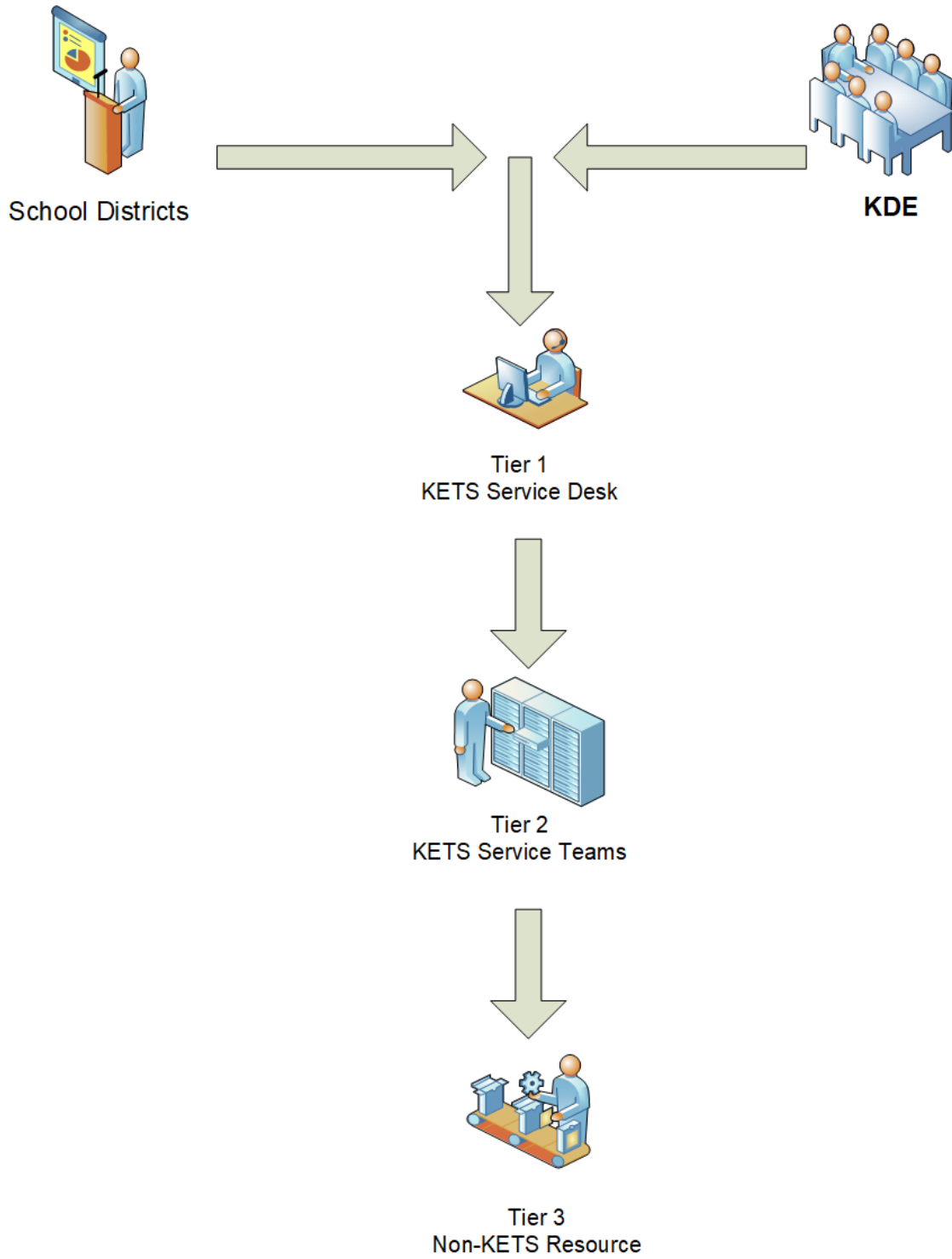

Description

The KETS Service Desk provides support to both internal and external KETS customers. Internal customers are defined as the Kentucky Department of Education (KDE) including the Kentucky School for the Blind (KSB) and the Kentucky School for the Deaf (KSD) as well as districts (171) and schools (approximate 1,400) throughout the state of Kentucky. The KETS Service Desk also services external customers defined as the general public who need assistance with any public facing technology that KDE provides such as web applications.

The KETS Service Desk resolves technical issues and answers questions on the following platforms and services: messaging, Internet/network connectivity, public facing web applications, internal end-user technology service (KDE the agency only), Active Directory, and network security. Issues are generally resolved within 20 minutes, though more complex issues may take longer. Resolution may entail working directly with a Service Desk analyst for a short time (Tier 1), escalation of an issue to another team within KETS (Tier 2), or by escalation to another non-KETS resource (Tier 3). Examples of a Tier 3 resource may include vendor partners such as Extreme, Microsoft, and McAfee.

Service provided to KDE the agency is often the first level of triage meaning that the Service Desk encounters a wide range of issues varying between simple password resets all the way to workstation reimages. Support provided to the school districts is often more technical in nature as the issues escalated to the KETS Service Desk have already gone through layers of technical support within the school district. However, this varies from district to district depending on the size and availability of IT staff. Issues escalated to the KETS Service Desk by school districts are either issues that can't be solved in the district or issues where the district staff may not have the rights to change something such as DNS entries or firewall configurations.

Management Strategy

The KETS Service Desk is a process-driven entity and allows for seamless operation with KETS Service Teams. The KETS Service Desk is staffed each business day 7:30 AM – 5 PM Eastern. The KETS Service Desk is the central hub and entry point for accessing technical support for all KETS provided technology.

Future Plans

KDE plans to continue using this strategy for the foreseeable future.

KETS Technical Environment Information Document

District Financial System (Tyler Enterprise ERP, formerly MUNIS)

Section 005

Last Reviewed: 4/19/2024

Last Updated: 4/19/2024

Prepared By Martin Herbener

Kentucky Department of Education

Office of Education Technology

Division of School Technology Planning and Project Management

300 Sower Blvd.

Frankfort, KY 40601

(502) 564-2020

Summary

This document covers the district financial system, based on Tyler Technologies' Enterprise ERP (formerly known as MUNIS).

170 districts use a Cloud Service implementation; one district uses on-premise equipment. This document describes both implementations where applicable.

Visual Representation

1.1. On-Premise Network Overview

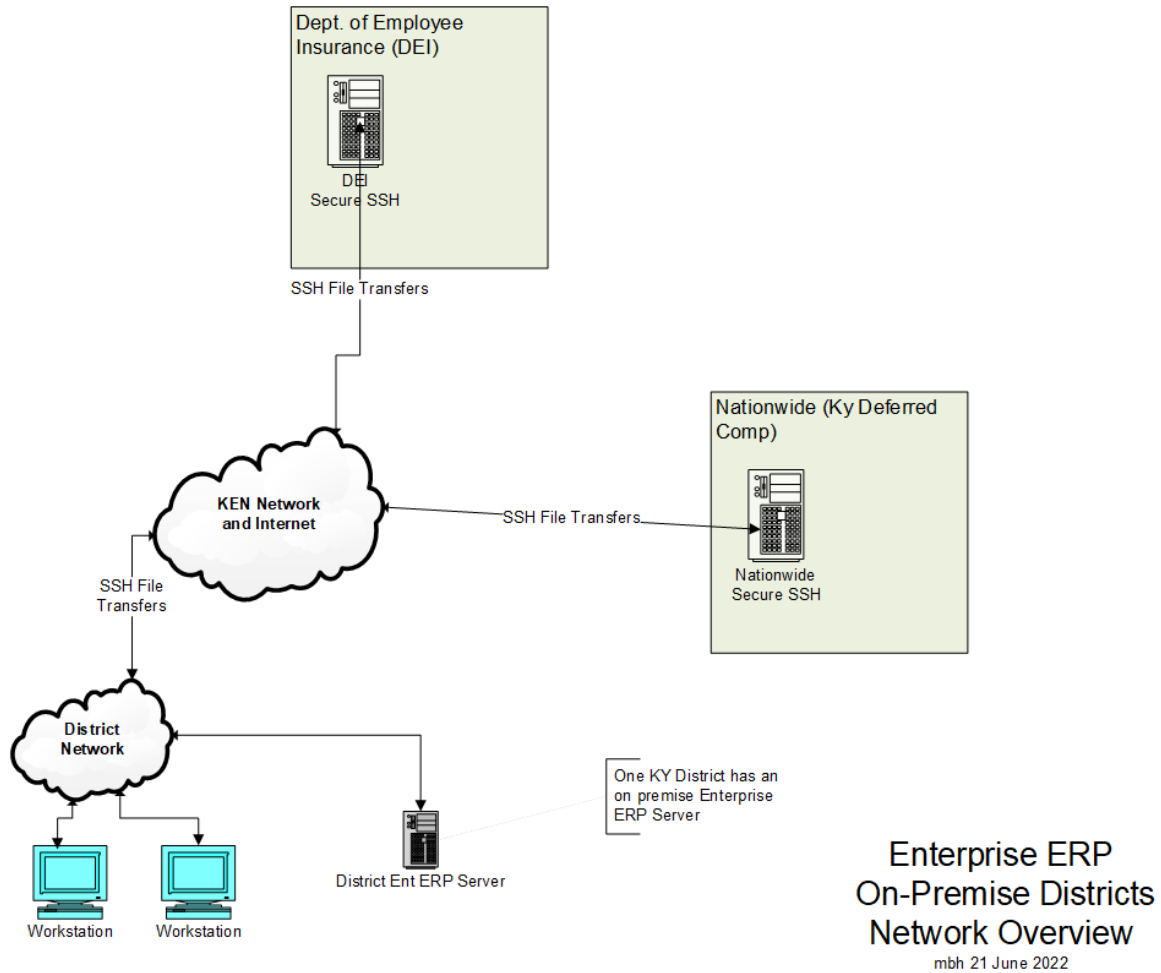

1.2. Cloud Service Network Overview

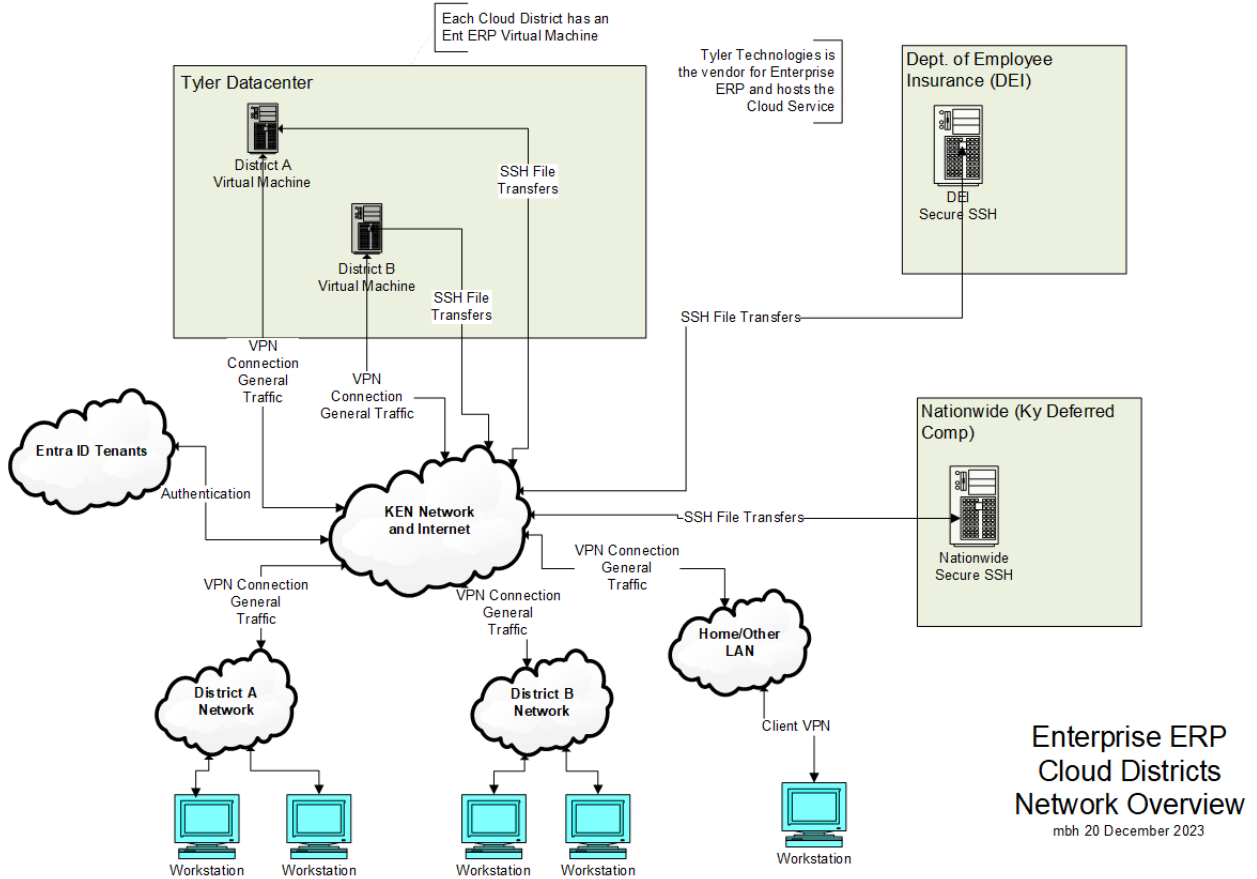

Description

Enterprise ERP (formerly known as MUNIS), from Tyler Technologies, is the financial system for Kentucky public school districts. For both the single remaining on-premise district and all Cloud districts it runs on Windows servers. Tyler Technologies hosts the Cloud districts in its own data centers. Most end user access requires connectivity to Tyler’s data centers through VPN; each district has a dedicated, Tyler-provided VPN device to provide this connectivity from computers on the district network, and Tyler also provides an end-user VPN service for user access from other locations.

Most functionality is browser-based, though a few specialized reporting features rely on additional client software. Tyler also maintains automated data transfers to and from the Commonwealth’s Department of Employee Insurance and Deferred Compensation vendor Nationwide.

Users are authenticated to both the end-user VPN (when used) and to certain specialized functions using Enterprise ERP-specific credentials. Users from cloud districts use their Entra ID accounts to authenticate to most Enterprise ERP functions.

Management Strategy

One remaining on-premise district in Kentucky has an Enterprise ERP server. Users, printers, security and operating system design are managed by the district with Tyler support.

For Cloud districts, users and printers are managed locally, while application updates, databases, security and the operating system are managed by Tyler.

KDE's Office of Finance and Operations provides policy guidance to districts regarding recording and reporting financial activities. KDE's Office of Education Technology provides oversight of technical operations and guides Kentucky-specific customizations of the system.

Future Plans

KDE plans to continue using the Tyler EERP solution for the foreseeable future.

Cloud district hosting will be moving from Tyler's datacenters to Amazon Web Services during 2024 and 2025. Other aspects of the system architecture, including connectivity and user authentication, will remain unchanged.

KETS Technical Environment Information Document

The KEN Network (Kentucky Education Network)

Section 006

Last Reviewed 04/25/2024

Last Updated: 12/2/2021

This section will be revised in summer 2024 as a result of the transition from AT&T to ENA..

Prepared by Howard Keeter

Reviewed by Keith Exley

Department of Education

Office of Education Technology

Division of School Technology Planning and Project Management

300 Sower Blvd.

Frankfort, KY 40601

(502) 564-2020

Summary

This document provides a brief, high-level view of the layout of the Kentucky Educational Technology System (KETS) networking environment throughout the Commonwealth of Kentucky. This document does not provide vendor-specific information with regard to network components, nor does it provide component level configuration information.

Visual Representation

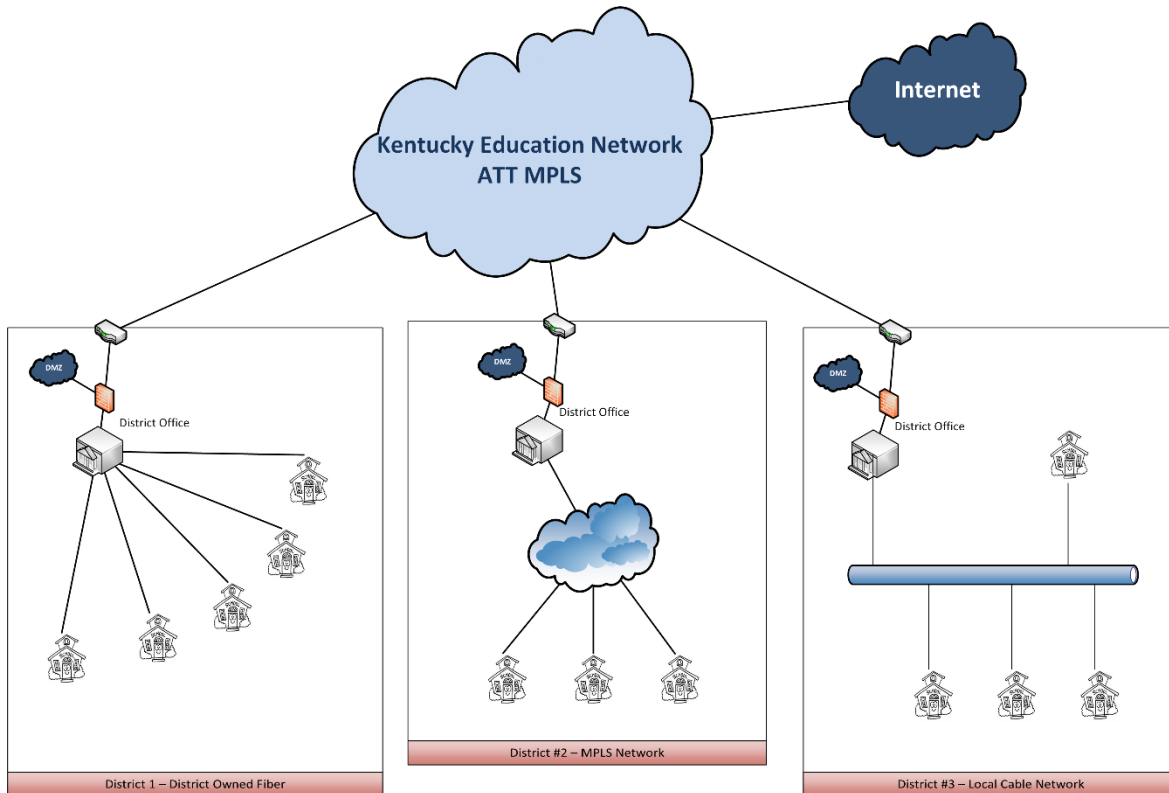

Description

The Kentucky Education Network (KEN) network consists of 1200+ schools in 171 districts. There are over 1 million end user devices and servers serviced by KEN. Approximately 100,000 staff members and 650,000 students are consumers of the services of the network.

The current Kentucky Education Network consists of an MPLS backbone supplied by AT&T. The school districts have direct Internet connection via this MPLS backbone. Only services housed at a state level require connection to the Kentucky Department of Education. Each district connects to the backbone via an Ethernet hand off with lines speeds from 100Mb/s to 10Gb/s. At this district level the Kentucky Department of Education supplies a managed firewall, traffic management device, and shared services

switch solution. This is the demarcation point between the services supplied by the Kentucky Department of Education and district owned and managed services. In most cases the district connects to the managed firewall via a layer 3 switch or routing device. The buildings that make up the district connect to the district's hub site by any direct method that is available to them for that location. It cannot be assumed that all buildings in a district contain classrooms. Some examples of buildings with alternative uses are bus garages, athletic complexes, and technology and maintenance centers. The variety of connections can include methods such as District owned fiber or Managed Ethernet Services with line speeds from 100Mb/s to 10Gb/s. Inside each building there is at least one wiring distribution frame where the local Ethernet switches and additional components (such as phone systems and video distribution systems) are located. Classroom wiring is completed as homeruns back to these wiring distribution frames. Wiring between distribution frames inside a building is generally completed by the use of multi-mode fiber optic cable. If wiring is needed between buildings on a campus, it is encouraged that it be done with the use of single mode fiber optic cable.

Management Strategy

The Office of Educational Technology, with the assistance of vendor partners, supports and maintains all centralized KETS shared service level and distributed components, including Firewalls, VPN servers, Traffic Management devices, etc. for all 171 school districts. Additionally, all hardware components, Leased-Line connectivity, and configuration management for connectivity between the school district's hub site and the state is funded and managed by OET. OET sets standards for all other network-related components and negotiates contracts on behalf of the school districts with approved vendors. OET also provides design and configuration assistance to school districts on an as-needed basis. School districts are responsible for all networking components and their configuration and management within their own LANs on their side of the KETS Firewall.

Future Plans

KDE is transitioning from the AT&T-based backbone to one provided by ENA (Education Networks of America), but the general high-level design and approach remains similar. More detail will be provided in an upcoming release of this document.

KETS Technical Environment Information Document

Security

Section 007

Last Reviewed: 4/19/2024

Last Updated: 4/19/2024

Prepared By Paul Shoemaker

Department of Education

Office of Education Technology

Division of School Technology Planning and Project Management

300 Sower Blvd.

Frankfort, KY 40601

(502) 564-2020

Summary

This document provides an overview of the Network Security Services provided by the Office of Educational Technology (OET) for the Kentucky Educational Technology System (KETS). This document only covers security services supported by the OET Network Security Team and Contracted Network Management Services with AT&T Network Services.

Visual Representation

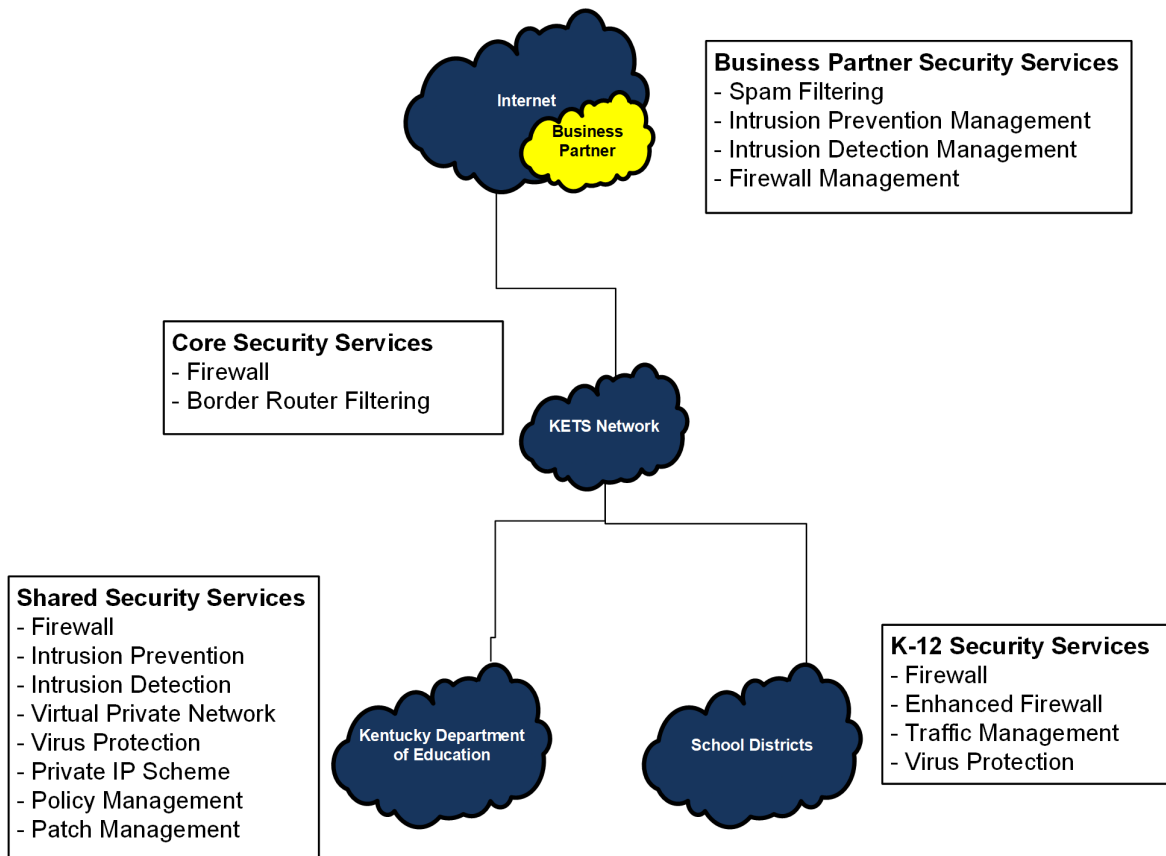

Description

Network Security Services include the following:

1. Intrusion Detection – Systems that passively monitor and detect harmful network traffic or attacks
2. Border Router Filtering – Basic filters placed on border routers which filter out common “noise” before it hits security devices
3. Firewall Services – Systems that provide security of outward facing network connections.
4. Enhanced Firewall – Additional protection for end user devices when connecting to outside networks.
5. SPAM Filtering – Systems that monitor and remove unwanted e-mail sent to the KETS network
6. Intrusion Prevention – Systems that actively look for harmful network traffic or attacks and reset connections as needed
7. Virtual Private Networking – Systems that allow secured access to the KETS Network from outside networks
8. Virus Protection – Virus detection and removal software that is loaded on all workstations and servers in the KETS network
9. Traffic Management – Systems that can either guarantee or limit the amount of traffic of any specific type on the network
10. Certificate Services (Internal usage only) – A root certificate authority tied to the KETS AD forest is established at KDE. Districts wanting to implement certificate services may stand up their own subordinate certificate server to be used for wireless authentication and other certificate related authentication practices required in the district
11. Policy Management – Baseline rule sets for firewalls, virus protection, VPN, and other security-related systems
12. Patch Management – Systems that monitor status of and install patches to operating systems and other software within the KETS network
13. Private IP Scheme – Standardized assignment of Private Internet Protocol addresses to devices within the KETS network, as well as Network Address Translation to allow some of these devices to interact with the Internet

Management Strategy

Intrusion Detection, Firewall Services, Enhanced Firewall services, SPAM Filtering, Intrusion Prevention, Traffic Management, and Virtual Private Networking are all managed by a combination of the OET Network Security Team, Microsoft Office365 and Contracted Network Management Services (AT&T). Policy Management is managed by a combination of the OET Network Security Team and relevant vendors. Border Router Filtering is cooperatively managed by the OET Network Security Team and AT&T Network Services and Contracted Network Management Services with AT&T Network Services that handle daily maintenance and updates while the OET Network Security Team handles defining policies. Virus Protection, Patch Management, and Private IP are supported by both the Network Security Team and local district support. Certificate services are granted to districts’ subordinate certificate servers through KDE. Districts

issue, expire and reclaim certificates to their end users through their own support local support services.

Future Plans

KETS is transitioning from AT&T managed services to ENA (Education Networks of America) during the 2023-2024 school year, but the basic services provided and management approach is not changing.

KETS Technical Environment Information Document

Kentucky Student Information System (Infinite Campus)

Section 008

Last Reviewed: 2/16/2024

Last Updated: 2/16/2024

Prepared By Martin Herbener

Department of Education

Office of Education Technology

Division of School Technology Planning and Project Management

300 Sower Blvd.

Frankfort, KY 40601

(502) 564-2020

Summary

The Kentucky Student Information System (KSIS), based on Infinite Campus, is the system of record for most student-level data for all public school districts across Kentucky and allows districts and KDE to create reports for decision-making purposes. KSIS is cloud-based (hosted by Infinite Campus) for all districts and for the state-level components using a Software as a Service model.

Visual Representation

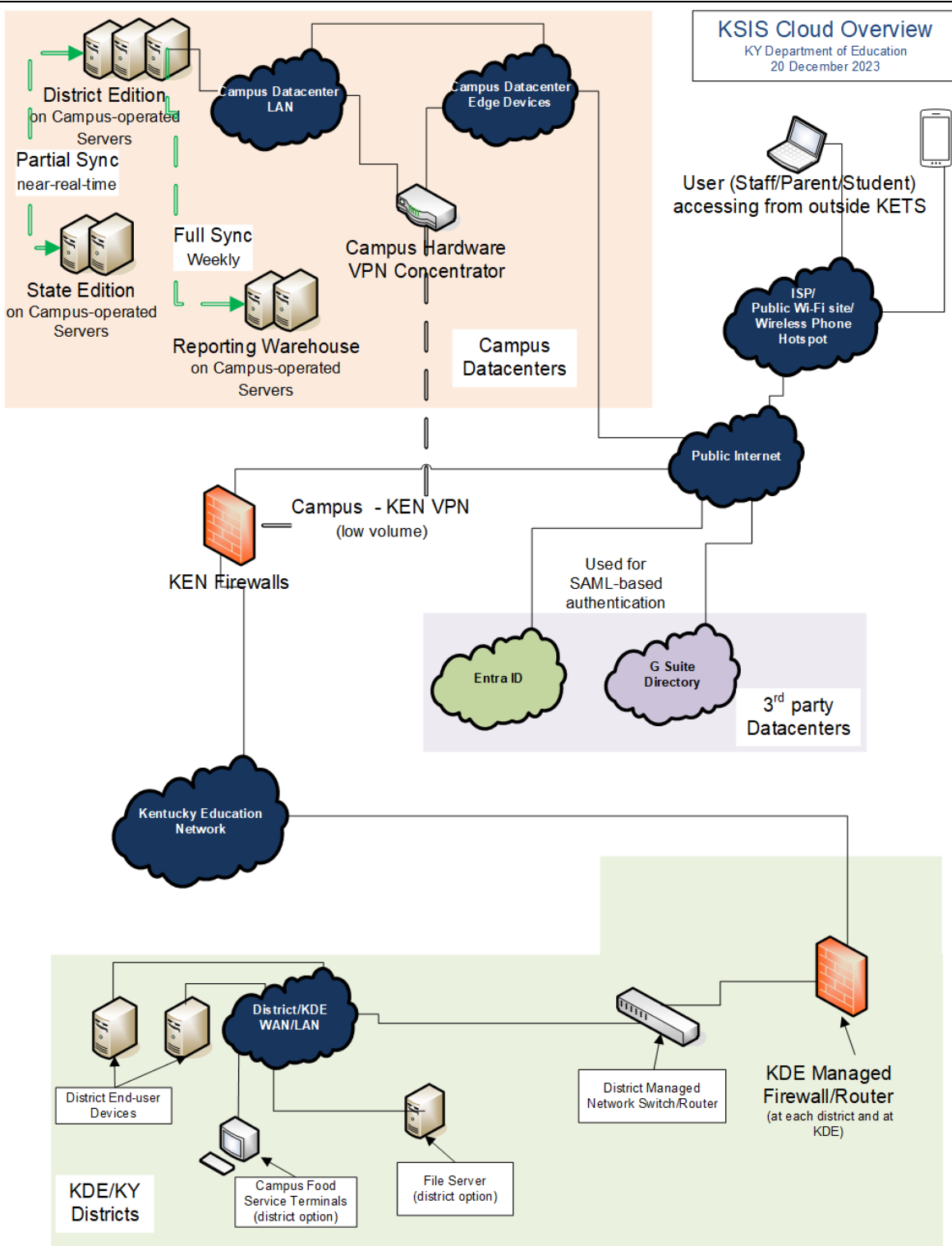

Description

Infinite Campus provides the KETS standard student information system. This system includes three main components:

- Infinite Campus District Edition
- Infinite Campus State Edition
- State Reporting Warehouse

Plus several optional (per-district) components:

- Food Service
- Messenger with Voice
- Campus Learning Suite
- Online Registration
- Campus Analytics Suite

Infinite Campus District Edition is the application used by school and district staff – teachers, administrators, and support staff. It tracks data such as attendance, grades, behavior, student demographics, schedules, fees, instructional plans, and health. It produces numerous reports and constantly synchronizes certain data elements with the centralized Infinite Campus State Edition installation. As a web-based application it is accessible anywhere in the district and from the general Internet. Campus Student and Campus Parent interfaces, with accompanying mobile apps, are available for those populations to use.

Infinite Campus State Edition is the application used by KDE and other state-level staff. It automatically receives certain data elements from each District Edition installation for reporting purposes. It is also used to manage district, school, and in rare cases (such as duplicate student ID cleanup) student records.

The **State Reporting Warehouse** is a single SQL Server database instance which contains copies of all the Infinite Campus District Edition databases, updated weekly. This database is used as the source for reports that required detailed data which are not synchronized to the Infinite Campus State Edition application.

Infinite Campus Food Service is an optional module that manages cafeteria menus and links with Point of Sale devices to process food service transactions.

Infinite Campus Messenger with Voice is an optional module that places voice phone calls and/or SMS (text) messages to staff, students and/or parents based on triggers (such as absences) or manual input (such as to announce special events).

Most districts have integrated their Campus District Edition installations with either Microsoft's Entra ID or the Google Directory using the SAML protocol so that staff and/or students can log into Campus using credentials from those external systems.

Management Strategy

The Kentucky Student Information System based on Infinite Campus is operated as a service provided by Infinite Campus. Infinite Campus owns, monitors and administers all equipment other than Point of Sale terminals. KDE (through a contracted organization) is responsible for the network infrastructure used by districts to connect to the Internet, while districts are responsible for their local networks, client devices, and Point of Sale terminals. A dedicated VPN connection between the KETS and Infinite Campus networks, which is used for a limited set of data transfers, is jointly managed by Infinite Campus and the Internet vendor.

Future Plans

KDE plans to continue using Infinite Campus systems indefinitely.

KDE does not expect any changes to the architecture of the Infinite Campus environment in the near future.