



Kentucky Department of
E D U C A T I O N

2024
Kentucky
School Bus
Purchasing Guide





**Kentucky Department of Education
2024 Blue Bird School Bus Purchase Authorization**

The _____ Board of Education, located in _____ Kentucky, on the ____ day of _____, 20____, in a legally called and constituted meeting, voted to purchase school buses through the Commonwealth of Kentucky contract price procedure.

This Board of Education took this official action to authorize the Chief State School Officer to procure 2024 school buses. This action, as spread upon the minutes of the meeting of this Board of Education on the above date, should be construed as evidence of obligation of this Board of Education to purchase the above school buses through the Commonwealth of Kentucky contract agreements established in accordance with statutory authority.

Signed

_____, Secretary
_____, Superintendent
of the _____ Board of Education
On the ____ day of _____, 20____.

BODY SIDE NUMBERS: Indicate the body side number the Board of Education wants painted on the side of the body of each school bus. Match body side number to individual item numbers. Example: Item 1 - Side number - 5, 6, 7, 8

Attach additional information if necessary.

Due to supply chain issues, current lead times for bus school completion is as follows:

- Type A school buses – approximately 270 days after receipt of order.
- Type C school buses – approximately 180 days after receipt of order.
- Type D (FE and RE) school buses – approximately 365 days after receipt of order.



BLUE BIRD
Blue Bird Corporation
School Bus Options

NOTE: All Type A school buses have hydraulic brakes and have a left-side center fuel tank. All Type C school buses have center rear fuel tanks.

Special Needs Diesel School Buses

Item #	Quantity	Bus Type	Capacity	Engine	Chassis	HP	Transmission	Wheel Base	Rear Axle Overhang	Base Purchase Price
BB1		C	22	Cummins	Blue Bird	220	Allison 2500	189	125	\$130,030
BB2		C	23	Cummins	Blue Bird	220	Allison 2500	217	132	\$130,590
BB3		C	28	Cummins	Blue Bird	220	Allison 2500	273	153	\$134,765
BB4		C	28	Cummins	Blue Bird	250	Allison 3000	273	153	\$141,950
BB5		D - RE	63	Cummins	Blue Bird	250	Allison 3000	273	122	\$199,000

Special Needs Propane School Buses

Item #	Quantity	Bus Type	Capacity	Engine	Chassis	HP	Transmission	Wheel Base	Rear Axle Overhang	Base Purchase Price
BB6		A	8 + 2	Ford	Blue Bird	262	Ford	158	91	\$157,190
BB7		C	22	Ford	Blue Bird	320	Ford	189	125	\$142,425
BB8		C	23	Ford	Blue Bird	320	Ford	217	132	\$144,020
BB9		C	28 EXT	Ford	Blue Bird	320	Ford	273	153	\$149,965

Special Needs Electric School Bus

Item #	Quantity	Bus Type	Capacity	Engine	Chassis	HP	Transmission	Wheel Base	Rear Axle Overhang	Base Purchase Price
BB10		A	8 + 2	Borg-Warner	Blue Bird	Electric	Electric	158	91	\$329,990



Type C – Diesel School Buses

Item #	Quantity	Bus Type	Capacity	Engine	Chassis	HP	Transmission	Wheel Base	Rear Axle Overhang	Base Purchase Price
BB11		C	34	Cummins	Blue Bird	220	Allison 2500	169	125	\$120,910
BB12		C	34	Cummins	Blue Bird	220	Allison 2500	189	125	\$122,605
BB13		C	52	Cummins	Blue Bird	220	Allison 2500	217	132	\$122,960
BB14		C	66	Cummins	Blue Bird	220	Allison 2500	273	153	\$128,370
BB15		C	66	Cummins	Blue Bird	250	Allison 3000	273	153	\$135,355
BB16		C	72	Cummins	Blue Bird	220	Allison 2500	273	160	\$129,345
BB17		C	72	Cummins	Blue Bird	250	Allison 3000	273	160	\$136,575
BB18		C	75	Cummins	Blue Bird	250	Allison 3000	280	174	\$137,795

Type A/C – Propane School Buses

Item #	Quantity	Bus Type	Capacity	Engine	Chassis	HP	Transmission	Wheel Base	Rear Axle Overhang	Base Purchase Price
BB19		A	22	Ford	Blue Bird	262	Ford	158	91	\$149,790
BB20		C	34	Ford	Blue Bird	320	Ford	189	125	\$132,020
BB21		C	52	Ford	Blue Bird	320	Ford	217	132	\$136,450
BB22		C	66	Ford	Blue Bird	320	Ford	273	139	\$142,770
BB23		C	72 EXT	Ford	Blue Bird	320	Ford	273	160	\$145,730
BB24		C	75 EXT	Ford	Blue Bird	320	Ford	280	174	\$148,235

Type A/C – Electric School Buses

Item #	Quantity	Bus Type	Capacity	Engine	Chassis	HP	Transmission	Wheel Base	Rear Axle Overhang	Base Purchase Price
BB25		A	22	Borg-Warner	Blue Bird	Electric	Electric	158	91	\$329,790
BB26		C	72	Cummins	Blue Bird	Electric	Electric	273	160	\$389,405



Type D – Diesel School Buses

Item #	Quantity	Bus Type	Capacity	Engine	Chassis	HP	Transmission	Wheel Base	Rear Axle Overhang	Base Purchase Price
BB27		D - FE	78	Cummins	Blue Bird	250	Allison 3000	232	153	\$161,625
BB28		D - RE	78	Cummins	Blue Bird	250	Allison 3000	273	122	\$181,800

Type D – Electric School Bus

Item #	Quantity	Bus Type	Capacity	Engine	Chassis	HP	Transmission	Wheel Base	Rear Axle Overhang	Base Purchase Price
BB29		D - RE	78	Cummins	Blue Bird	Electric	Electric	273	122	\$415,890



BLUE BIRD

**Blue Bird Corporation
Optional School Bus Products**

Radio Options

Item #	Bus Type	Description	Price
BBO1	ALL	Radio, AM/FM/PA	\$800.00
BBO2	ALL	Radio, AM/FM/PA (w/ External Speaker)	\$850.00

Camera Options

Item #	Bus Type	Description	Price
BBO3	ALL	REI - 6 channel DVR-HD6-600 w/1 camera and 500 GB Hard Drive (INCLUDES INSTALL and 5 YEAR PARTS WARRANTY)	\$2,450.00
BBO4	ALL	REI - 1 TB Hard Drive Upgrade	\$300.00
BBO5	ALL	REI - Additional Camera Head - (INCLUDES INSTALL)	\$450.00
BBO6	ALL	REI - GPS Sensor (for speed) - (INCLUDES INSTALL)	\$250.00
BBO7	ALL	REI - Stop Arm Camera - (INCLUDES INSTALL)	\$600.00
BBO8	ALL	REI - In Bus Video Lock Box	\$150.00
BBO9	ALL	REI - Event Marker and Panic Button - (INCLUDES INSTALL)	\$200.00
BBO10	ALL	REI - 500 GB Hard Drive (SPARE)	\$500.00
BBO11	ALL	REI - 1 TB Hard Drive (SPARE)	\$600.00
BBO12	ALL	REI - 12 channel DVR-HD12-600 w/ 1 camera and 1TB Hard Drive (INCLUDES INSTALL and 5 YEAR PARTS WARRANTY)	\$3,250.00
BBO13	ALL	Perimeter View 360 Degree Camera (See representative for install cost) (INCLUDES 5 YEAR PARTS WARRANTY)	\$3,000.00

Luggage Options

Item #	Bus Type	Description	Price
BBO14	C	Type C - Left Hand Overhang Storage	\$1,500.00
BBO15	C	Type C - Right Hand Overhang Storage	\$1,500.00
BBO16	C	Type C - Left Hand Mid Mount Storage	\$1,600.00
BBO17	C	Type C - Right Hand Mid Mount Storage	\$1,600.00
BBO18	D - FE	Type D - Left Hand Overhang Storage	\$1,600.00
BBO19	D - FE	Type D - Right Hand Overhang Storage	\$1,600.00



Item #	Bus Type	Description	Price
BBO20	D	Type D - Left Hand Mid Mount Storage	\$1,700.00
BBO21	D	Type D - Right Hand Mid Mount Storage	\$1,700.00
BBO22	D - RE	Type D - Pass Through Luggage	\$5,950.00
BBO23	ALL	Gas Shocks (Single Door)	\$150.00
BBO24	ALL	Gas Shocks (Double Door)	\$300.00

Air Conditioning A/C Options

Item #	Bus Type	Description	Price
BBO25	C	Type C - 95,000 BTU Skirt Mount AC (34 Pax)	\$11,950.00
BBO26	C	Type C - 110,000 BTU Skirt Mount AC (52-66 Pax)	\$12,500.00
BBO27	C	Type C - 126,000 BTU Skirt Mount AC (72-75 Pax)	\$12,900.00
BBO28	C	Type C - 126,000 BTU Rooftop AC (52-75 Pax)	\$13,900.00
BBO29	D	Type D - 126,000 BTU Skirt Mount AC	\$13,500.00
BBO30	D	Type D - 136,000 BTU Rooftop AC	\$14,500.00

Tire Options

Item #	Bus Type	Description	Price
BBO31	C	LRH Upgrade (Michelin or Goodyear)	\$1,000.00

Items 32-36 are intentionally removed.



Seating Options

Item #	Bus Type	Description	Price
BBO37	ALL	(1) 39" CE White Child Safety Restraint Seat In lieu of Standard 39" HB Seat	\$875.00
BBO38	Lift Bus	(1) 30" CE White Child Safety Restraint Seat In lieu of Standard 30" HB Seat	\$800.00
BBO39	Lift Bus	(1) Track Mounted Barrier	\$350.00
BBO40	Lift Bus	(1) 30" Track Mounted Seat w/ Lap Shoulder Belt	\$850.00
BBO41	Lift Bus	(1) additional Wheelchair Position	\$350.00
BBO42	Lift Bus	Delete (1) Wheelchair Position and ADD (1) Standard HB Seats	\$350.00
BBO43	Lift Bus	39" HB Seat w/ 3pt belts in lieu of 30" HB Seat w/ 3pt belts (requires wheelchair lift to be moved to rear of the school bus)	\$350.00
BBO44	Lift Bus	Relocate Wheelchair Lift to rear of school bus	\$1,000.00

Miscellaneous Options

Item #	Bus Type	Option Type	Description	Price
BBO45	ALL	Brakes	Air Disc Brakes	\$1,950.00
BBO46	ALL	Tinting	Tinted Windows	\$750.00
BBO47	ALL	Heater	Espar Series Heater (includes 7-day timer)	\$1,995.00
BBO48	ALL	Ceiling	Full Length Perforated Ceiling	\$1,000.00
BBO49	ALL	Pedals	Adjustable Pedals	\$1,400.00
BBO50	C	Axles	23.5k Rear Axle Upgrade (may be required w/ 100-gallon tank or certain luggage configurations)	\$1,250.00
BBO51	C	Mirrors	Rosco Breakaway Mirrors	\$350.00
BBO52	C	Fuel Tank	100 Gallon Diesel Fuel Tank	\$750.00
BBO53	ALL	Mud Flaps	Blue Bird Mud Flaps (Required w/ Skirt AC)	\$150.00
BBO54	ALL	Flooring	1 Piece Flooring (Gray Swirl)	\$1,200.00



BLUE BIRD

Central States Bus Sales Contact Information

Name	Position	Telephone Number	Email Address
Jeff Reitz	President & CEO	(800)-825-8273	jreitz@centralstatesbus.com
Chuck Harvill	General Manager	(877)-307-0322	charvill@centralstatesbus.com
Mark Parsons	General Manager – Kentucky	(866)-376-1644	mparsons@centralstatesbus.com
Mark Martinez	Sales Manager – Western Kentucky	(866)-376-1644	mmartinez@centralstatesbus.com

2024 Blue Bird Floor Plans

Name	Title	Phone Number	Email Address
Jeff Reitz	President & CEO	(800)-825-8273	jreitz@centralstatesbus.com
Chuck Harvill	General Manager	(877)-307-0322	charvill@centralstatesbus.com
Mark Parsons	General Manager – Kentucky	(866)-376-1644	mparsons@centralstatesbus.com
Mark Martinez	Sales Manager – Western Kentucky	(866)-376-1644	mmartinez@centralstatesbus.com

Delivery Date Estimates

- Type A school buses – approximately 270 days after receipt of order.
- Type C school buses – approximately 180 days after receipt of order.
- Type D (FE and RE) school buses – approximately 365 days after receipt of order.



BLUE BIRD

Quote Id: 223502 Body Plan / Seat Plan Information

Body Plan: 5014601

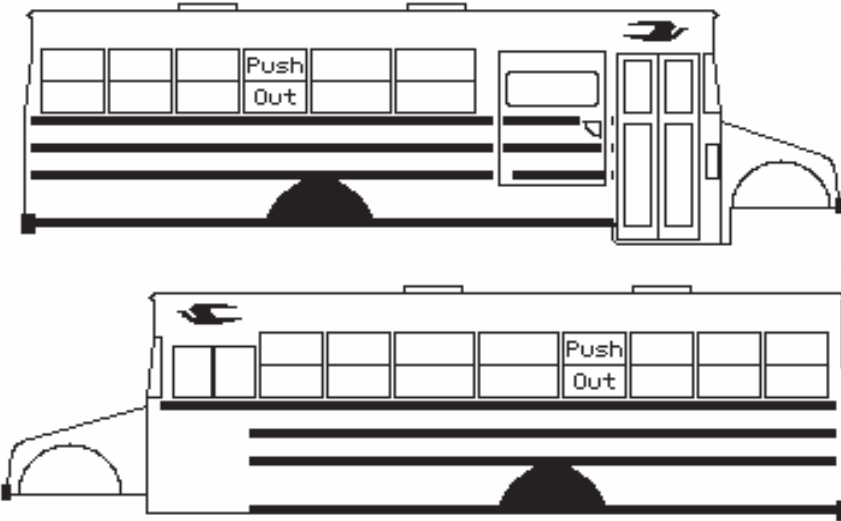

AT A GLANCE

ENGINE- Cummins
FUEL TYPE- Diesel
HP- 220
TRANS- Allison
SIZE- 2311
CAP- 22
WHEELBASE - 189"
ITEM #BB1

Seat Plan: 27937

SP: 27937 BBCV 2311, 22 CAP



Quote Id: 223502 Seat Plan Spacing Chart

SP: 27937 BBCV 2311, 22 CAP

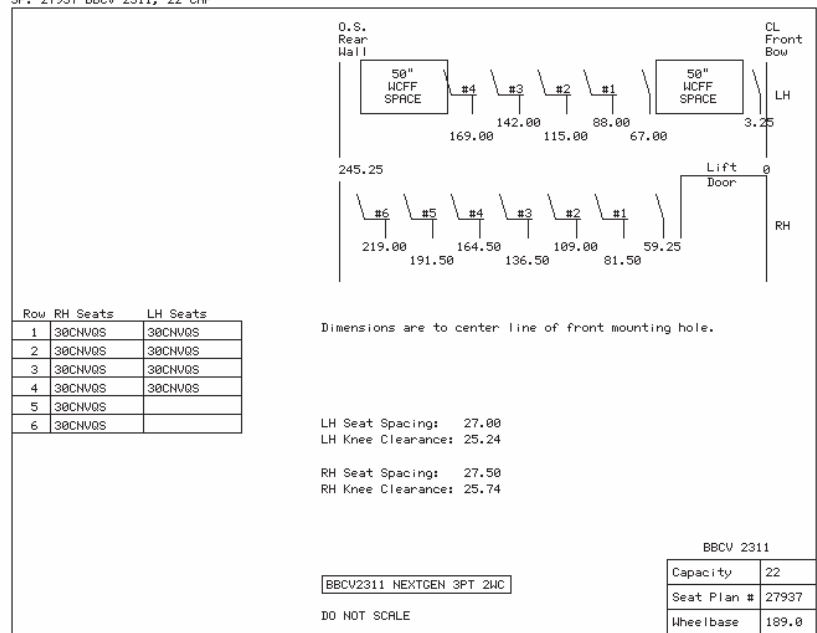

Quote Id: 223503 Body Plan / Seat Plan Information

Body Plan: 5014629

AT A GLANCE

ENGINE- Cummins ISB
FUEL TYPE- Diesel
HP- 220
TRANS- Allison
SIZE- 2610
CAP- 23
WHEELBASE - 217"
ITEM #BB2

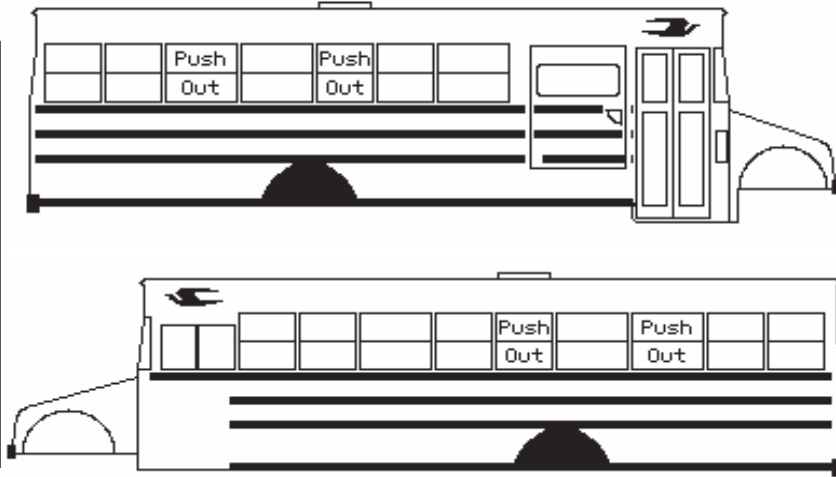

Seat Plan: 27130

SP: 27130 BBCV 2610, 23 CAP



Quote Id: 223503 Seat Plan Spacing Chart

SP: 27130 BBCV 2610, 23 CAP

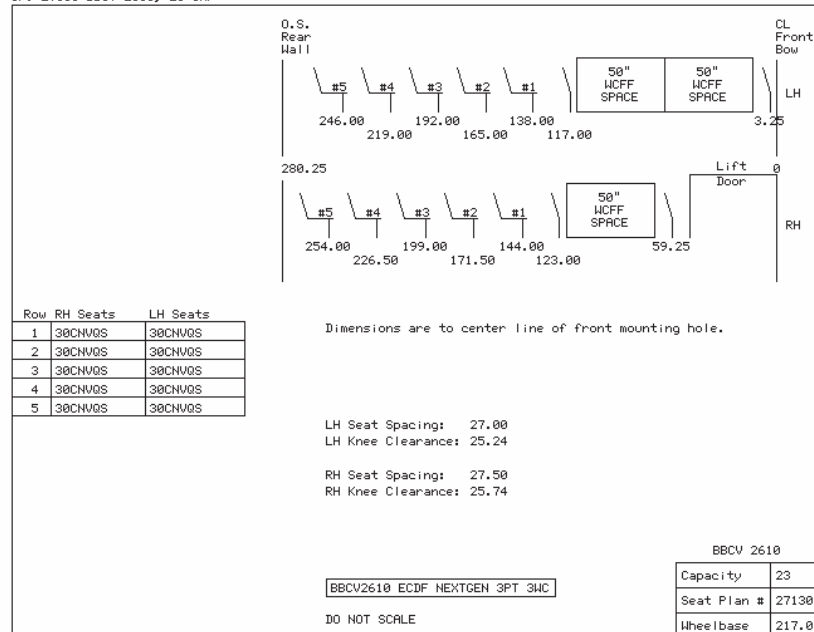

Quote Id: 223504 | Body Plan / Seat Plan Information

Body Plan: 5014628

AT A GLANCE

ENGINE- Cummins ISB
FUEL TYPE- Diesel
HP- 220
TRANS- Allison
SIZE- 3303
CAP- 28
WHEELBASE - 273"
ITEM #BB3

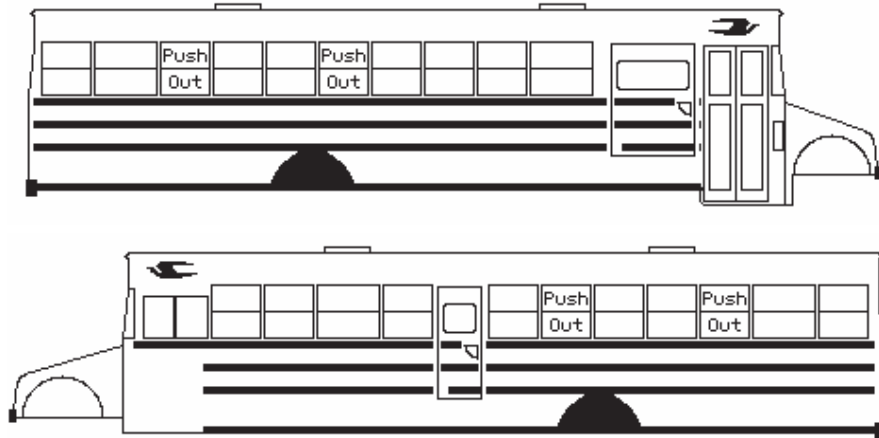

Seat Plan: 29268

SP: 29268 BBCV 3303, 28 CAP



Quote Id: 223504 | Seat Plan Spacing Chart

SP: 29268 BBCV 3303, 28 CAP

Dimensions are to center line of front mounting hole.

LH Seat Spacing: 28.50
 LH Knee Clearance: 26.74

RH Seat Spacing: 27.25
 RH Knee Clearance: 25.49

Row	RH Seats	LH Seats
1	30CNVQS	30CNVQS
2	30CNVQS	30CNVQS
3	30CNVQS	30CNVQS
4	30CNVQS	30CNVQS
5	30CNVQS	30CNVQS
6	30CNVQS	30CNVQS

BBCV 3303

Capacity	28
Seat Plan #	29268
Wheelbase	273.0

DO NOT SCALE



Quote Id: 223505 Body Plan / Seat Plan Information

Body Plan: 5014628

AT A GLANCE

ENGINE- Cummins ISB
FUEL TYPE- Diesel
HP- 250
TRANS- Allison
SIZE- 3303
CAP- 28
WHEELBASE - 273"
ITEM #BB4

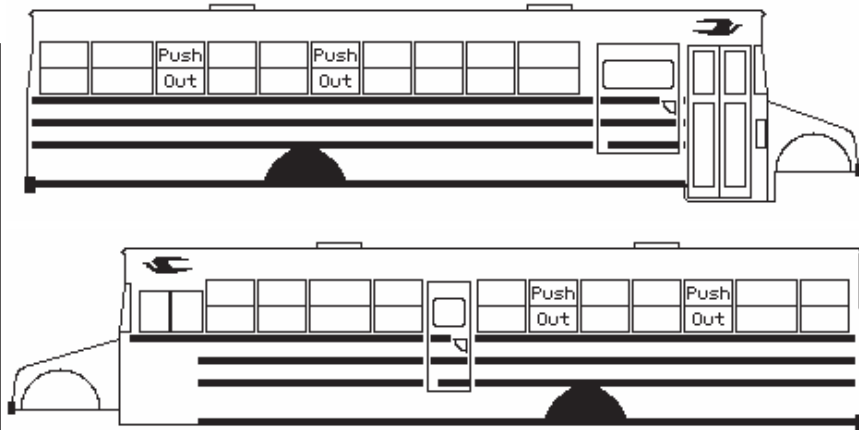

Seat Plan: 29268

SP: 29268 BBCV 3303, 28 CAP



Quote Id: 223505 Seat Plan Spacing Chart

SP: 29268 BBCV 3303, 28 CAP

Dimensions are to center line of front mounting hole.

LH Seat Spacing: 28.50
 LH Knee Clearance: 26.74
 RH Seat Spacing: 27.25
 RH Knee Clearance: 25.49

Row	RH Seats	LH Seats
1	30CNVQS	30CNVQS
2	30CNVQS	30CNVQS
3	30CNVQS	30CNVQS
4	30CNVQS	30CNVQS
5	30CNVQS	30CNVQS
6	30CNVQS	30CNVQS

BBCV 3303	
Capacity	28
Seat Plan #	29268
Wheelbase	273.0

BBCV3303 ECDF SED5L NEXTGEN 3PT 4HC

DO NOT SCALE



Quote Id: 223604 Body Plan / Seat Plan Information

Body Plan: 5015688

AT A GLANCE

ENGINE- Cummins ISB
FUEL TYPE- Diesel
HP- 250
TRANS- Allison
SIZE- 4006
CAP- 63
WHEELBASE - 273"
ITEM #BB5

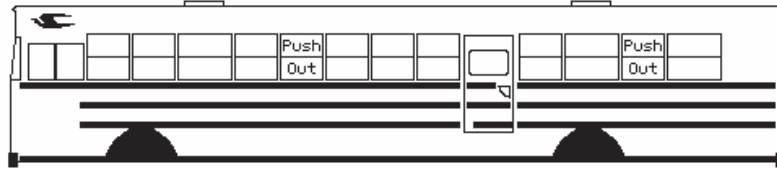
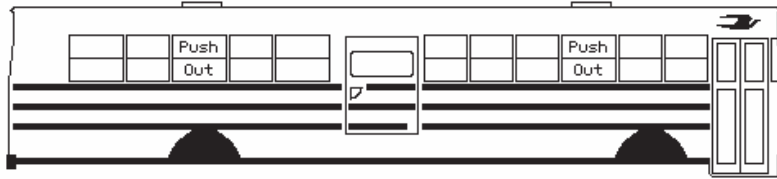

Seat Plan: 32079

SP: 32079 T3RE 4006, 63 CAP



Quote Id: 223604 Seat Plan Spacing Chart

SP: 32079 T3RE 4006, 63 CAP

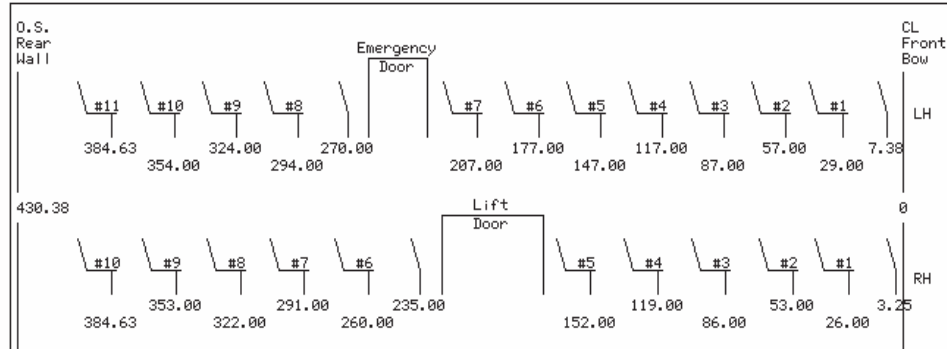

Row	RH Seats	LH Seats
1	39CHVQS	39CHVQS
2	39CHVQS	39CHVQS
3	39CHVQSTH	39CHVQSTH
4	39CHVQSTH	39CHVQSTH
5	39CHVQSTH	39CHVQSTH
6	39CHVQS	39CHVQSTH
7	39CHVQS	39CHVQSTH
8	39CHVQS	39CHVQS
9	39CHVQS	39CHVQS
10	39CHVQSDAV	39CHVQS
11		39CHVQSDAV

Dimensions are to center line of front mounting hole.

LH Seat Spacing: 28.00, 30.00
 LH Knee Clearance: 26.24, 28.24
 RH Seat Spacing: 27.00, 33.00, 31.00
 RH Knee Clearance: 25.24, 31.24, 29.24

T3RE4006 SED9L ECD7 HXGN 3PT 8TM

DO NOT SCALE

T3RE 4006	
Capacity	63
Seat Plan #	32079
Wheelbase	273.0

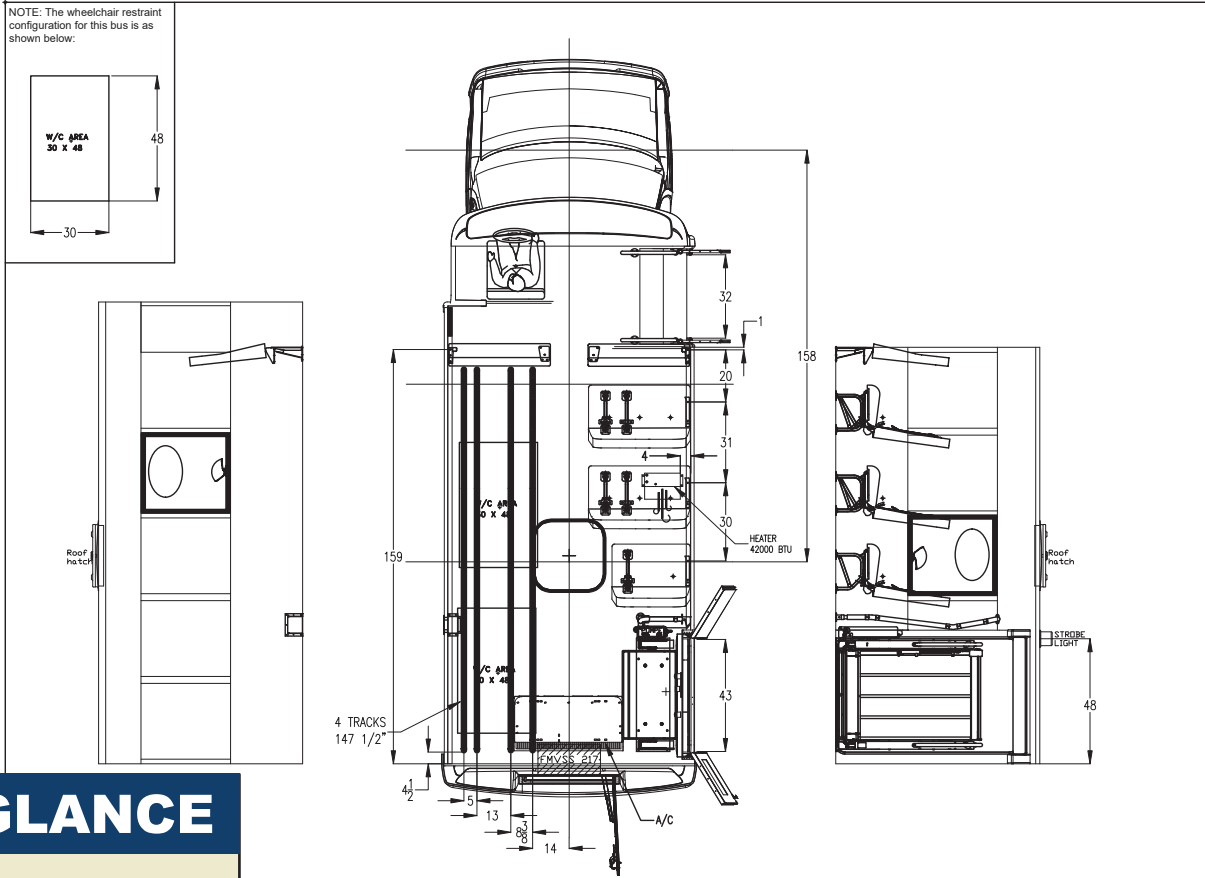

AT A GLANCE

BODY- Micro Bird
ENGINE- Ford
FUEL TYPE- Propane
HP- 262
TRANS- Ford
CAP- 8+2
WHEELBASE - 158"
ITEM #BB6

SEAT	DIM.	SIDE	QTY
S3	39	RH	2
S3	30	RH	1

Seat spacing = See drawing D.O.D.: 32"

APPROVED CONFIGURATIONS

Total ambulatory passengers : 8	Total wheel chair passengers : 2
Load cap. (pass. + cargo) : **kg **lbs	

2021/05/27	LR	CREATION DRAWING	Drawn by : LINE ROY	
REV. YYY/MM/DD	BY	DESCRIPTION	MODEL: UFH5 CRH WSS	
Stock Number:			UNIT = INCHES	Drawing no.
Customer Approval:			SCALE = DO NOT SCALE	053307
Date:			NOTE: Any option added to this floorplan shall be approved by the Corporation Micro Bird Inc. technical department.	

Quote Id: 223514 Body Plan / Seat Plan Information

Body Plan: 5014601

AT A GLANCE

ENGINE- Ford
FUEL TYPE- Propane
HP- 320
TRANS- Ford
SIZE- 2311
CAP- 22
WHEELBASE - 189"
ITEM #BB7

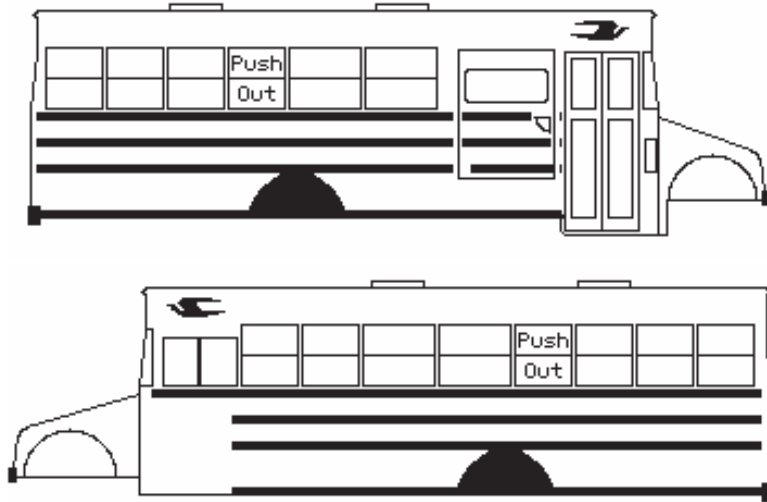

Seat Plan: 27937

SP: 27937 BBCV 2311, 22 CAP



Quote Id: 223514 Seat Plan Spacing Chart

SP: 27937 BBCV 2311, 22 CAP

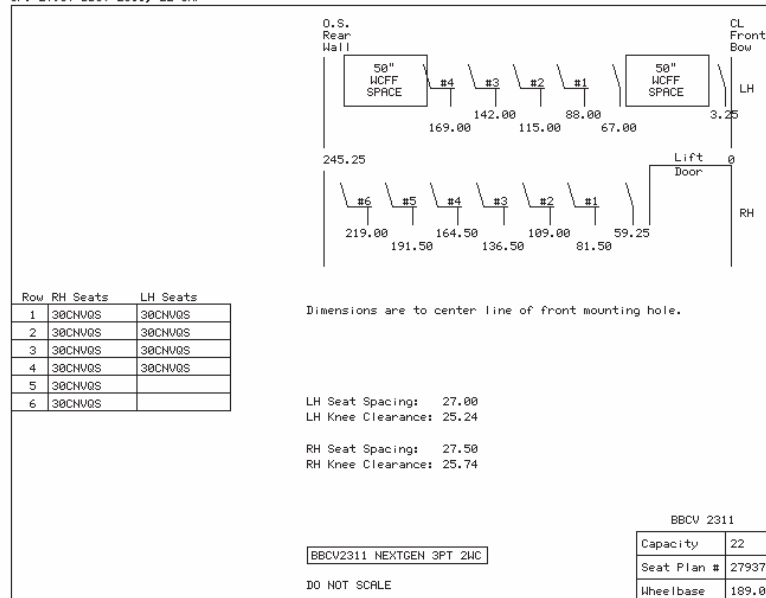



Quote Id: 223515 Body Plan / Seat Plan Information

Body Plan: 5014629

AT A GLANCE

ENGINE- Ford
FUEL TYPE- Propane
HP- 320
TRANS- Ford
SIZE- 2610
CAP- 23
WHEELBASE - 217"
ITEM #BB8

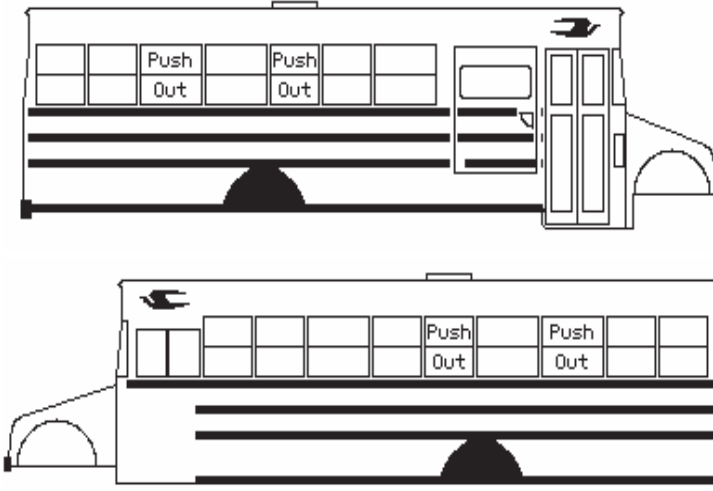

Seat Plan: 27130

SP: 27130 BBCV 2610, 23 CAP



Quote Id: 223515 Seat Plan Spacing Chart

SP: 27130 BBCV 2610, 23 CAP

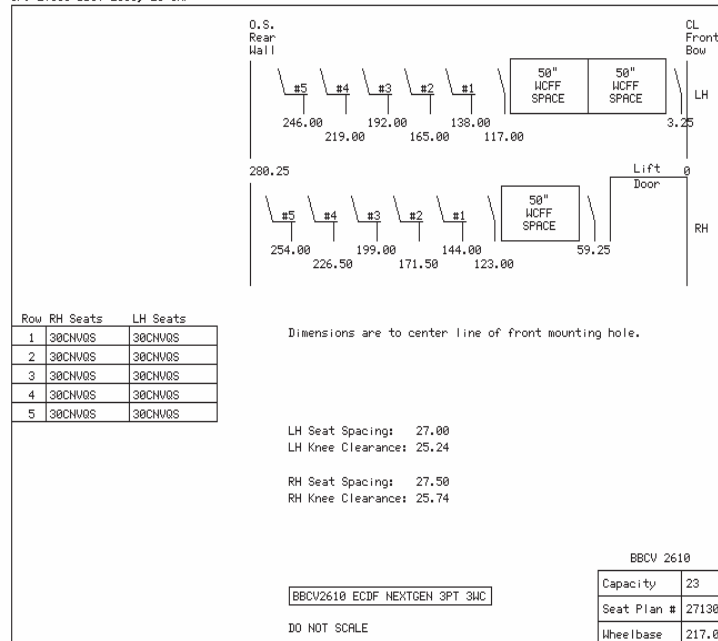



BLUE BIRD®

Quote Id: 223517 Body Plan / Seat Plan Information

Body Plan: 5014628

AT A GLANCE

ENGINE- Ford
FUEL TYPE- Propane
HP- 320
TRANS- Ford
SIZE- 3303
CAP- 28 EXT
WHEELBASE - 273"
ITEM #BB9

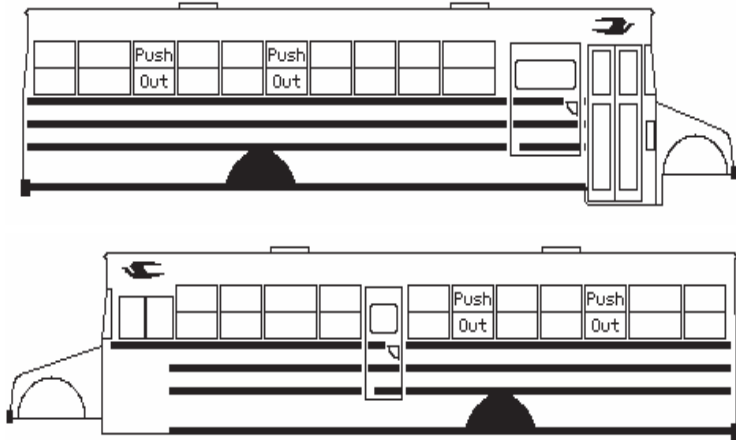

Seat Plan: 29268

SP: 29268 BBCV 3303, 28 CAP



Quote Id: 223517 Seat Plan Spacing Chart

SP: 29268 BBCV 3303, 28 CAP

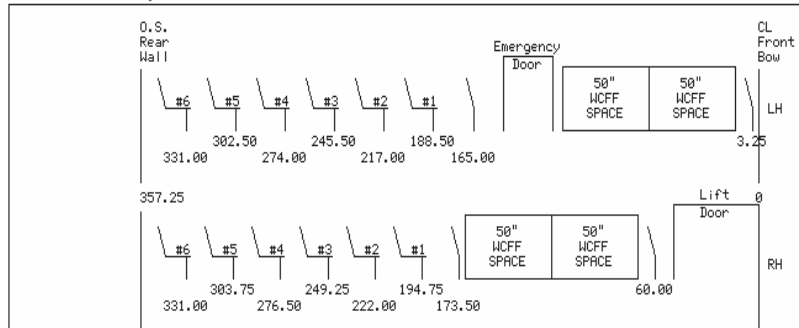

Row	RH Seats	LH Seats
1	30CNV0S	30CNV0S
2	30CNV0S	30CNV0S
3	30CNV0S	30CNV0S
4	30CNV0S	30CNV0S
5	30CNV0S	30CNV0S
6	30CNV0S	30CNV0S

BBCV3303 EDCF SED5L NEXTGEN 3PT 4NC

DO NOT SCALE

BBCV 3303	
Capacity	28
Seat Plan #	29268
Wheelbase	273.0

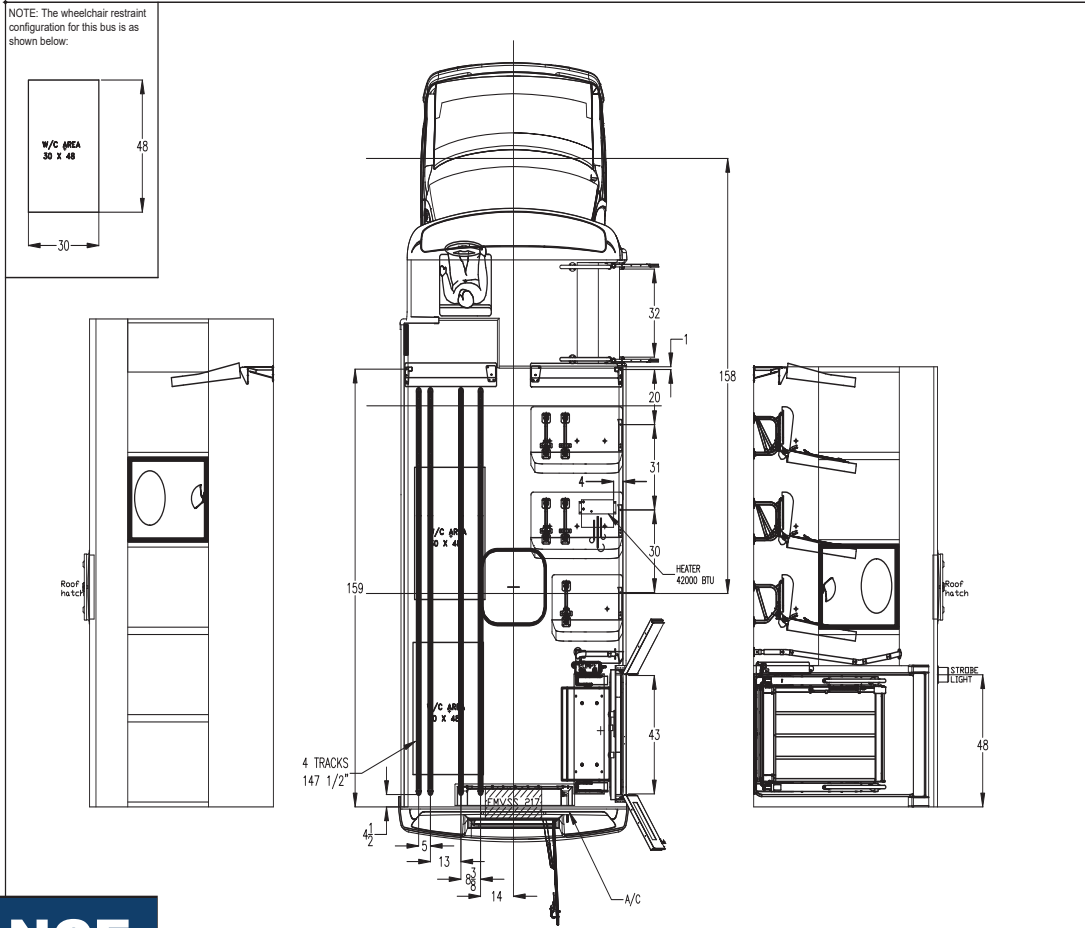

AT A GLANCE

BODY- MicroBird
ENGINE- Borg-Warner Remy
FUEL TYPE- Electric
HP- Electric
TRANS- Electric
CAP- 8+2
WHEELBASE - 158"
ITEM #BB10

SEAT	DIM.	SIDE	QTY	REV.	DATE	BY	DESCRIPTION	Drawn by :	LINE ROY
S3	39	RH	2	2021/05/27	LR		CREATION DRAWING		
S3	30	RH	1						
Seat spacing = See drawing				D.O.D.: 32"		MODEL: UFH5 CRH WSS			
APPROVED CONFIGURATIONS				Stock Number:		UNIT = INCHES Drawing no. 053359			
Total ambulatory passengers : 8		Total wheel chair passengers : 2		Customer Approval:		Date:		NOTE: Any option added to this floorplan shall be approved by the Corporation Micro Bird Inc. technical department.	
Load cap. (pass. + cargo) : **kg **lbs									

Quote Id: 223506 Body Plan / Seat Plan Information

Body Plan: 5014365

AT A GLANCE

ENGINE- Cummins ISB
FUEL TYPE- Diesel
HP- 220
TRANS- Allison
SIZE- 1910
CAP- 34
WHEELBASE - 169"
ITEM #BB11

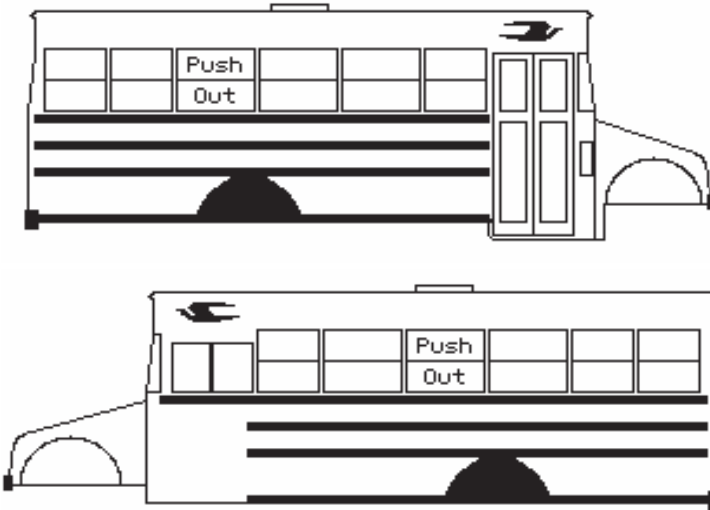

Seat Plan: 23136

SP: 23136 BBCV 1910, 34 CAP



Quote Id: 223506 Seat Plan Spacing Chart

SP: 23136 BBCV 1910, 34 CAP

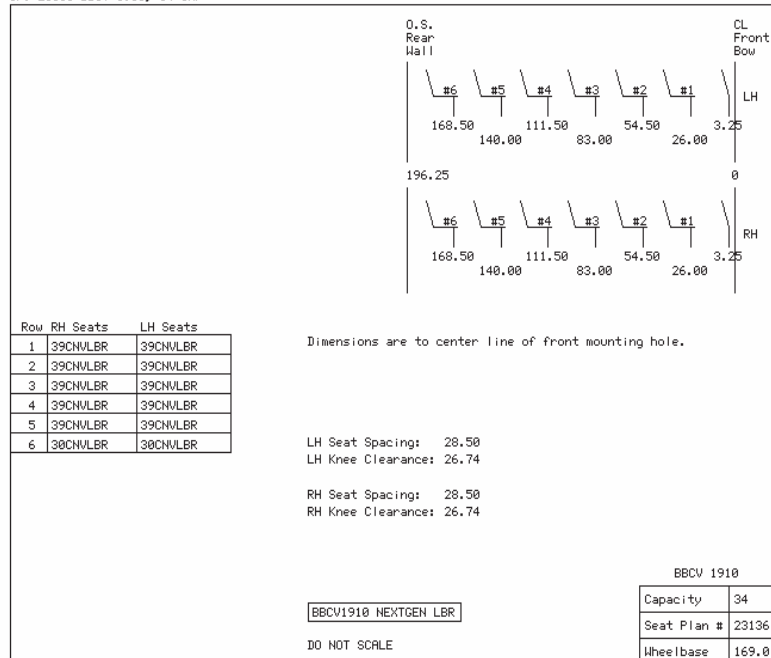



BLUE BIRD

Quote Id: 223507 Body Plan / Seat Plan Information

Body Plan: 5014346

AT A GLANCE

ENGINE- Cummins ISB
FUEL TYPE- Diesel
HP- 220
TRANS- Allison
SIZE- 2311
CAP- 34
WHEELBASE - 189"
ITEM #BB12

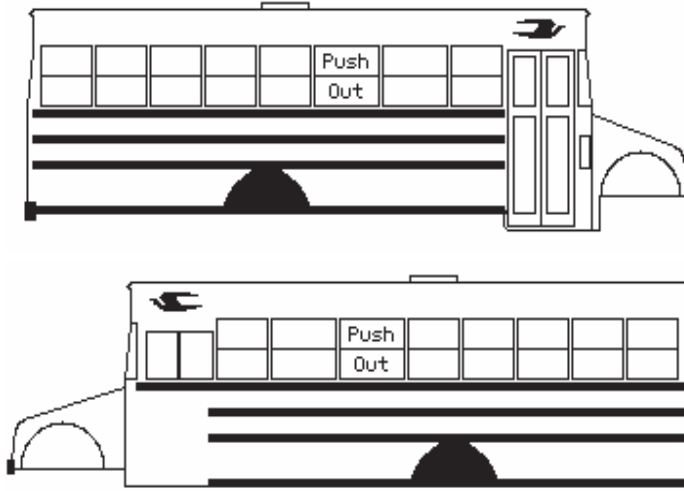

Seat Plan: 23137

SP: 23137 BBCV 2311, 34 CAP



Quote Id: 223507 Seat Plan Spacing Chart

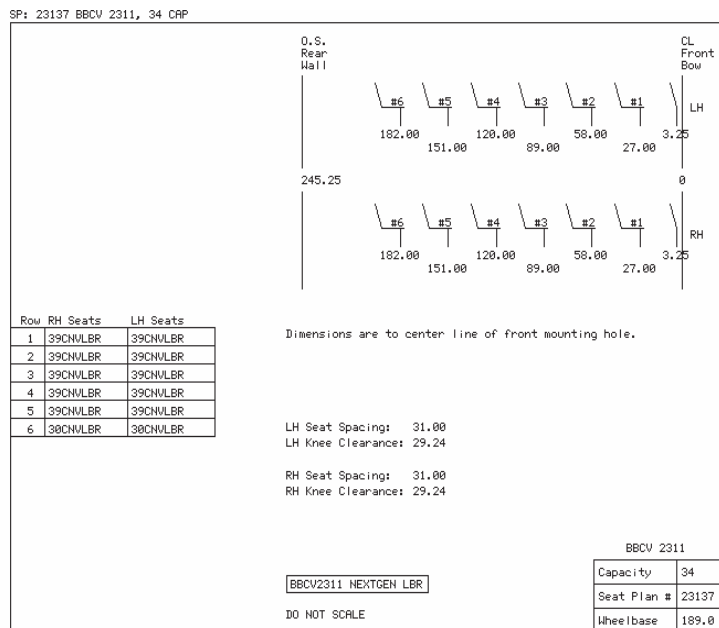

Quote Id: 223508 Body Plan / Seat Plan Information

Body Plan: 5014494

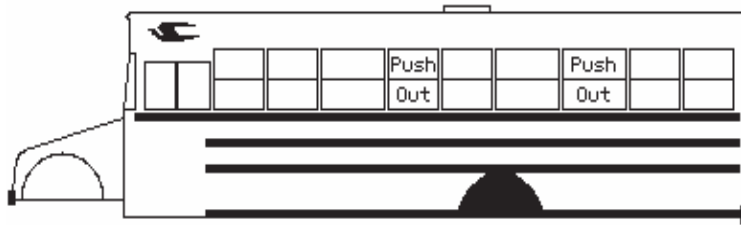
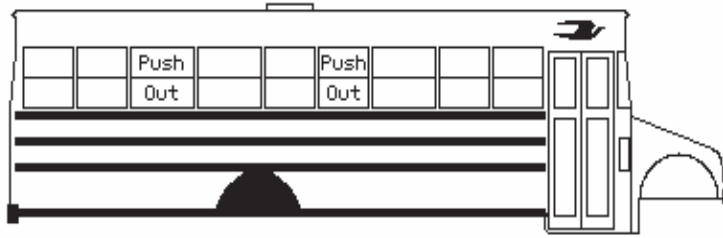

AT A GLANCE

- ENGINE- Cummins ISB
- FUEL TYPE- Diesel
- HP- 220
- TRANS- Allison
- SIZE- 2610
- CAP- 52
- WHEELBASE - 217"
- ITEM #BB13

Seat Plan: 23138

SP: 23138 BBCV 2610, 52 CAP



Quote Id: 223508 Seat Plan Spacing Chart

SP: 23138 BBCV 2610, 52 CAP

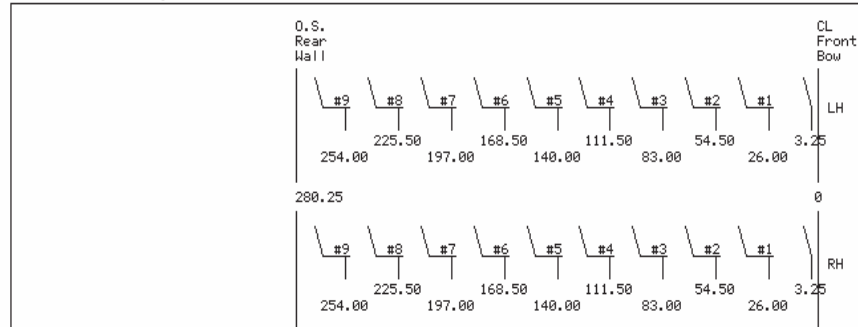

Row	RH Seats	LH Seats
1	39CNVLR	39CNVLR
2	39CNVLR	39CNVLR
3	39CNVLR	39CNVLR
4	39CNVLR	39CNVLR
5	39CNVLR	39CNVLR
6	39CNVLR	39CNVLR
7	39CNVLR	39CNVLR
8	39CNVLR	39CNVLR
9	30CNVLR	30CNVLR

Dimensions are to center line of front mounting hole.

LH Seat Spacing: 28.50
 LH Knee Clearance: 26.74
 RH Seat Spacing: 28.50
 RH Knee Clearance: 26.74

BBCV 2610	
Capacity	52
Seat Plan #	23138
Wheelbase	217.0

DO NOT SCALE



BLUE BIRD

Quote Id: 223509 Body Plan / Seat Plan Information

Body Plan: 5014345

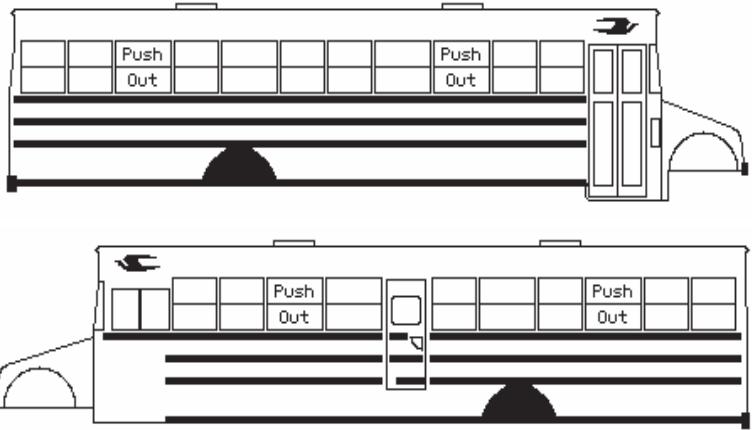

AT A GLANCE

ENGINE- Cummins ISB
FUEL TYPE- Diesel
HP- 220
TRANS- Allison
SIZE- 3201
CAP- 66
WHEELBASE - 273"
ITEM #BB14

Seat Plan: 25141

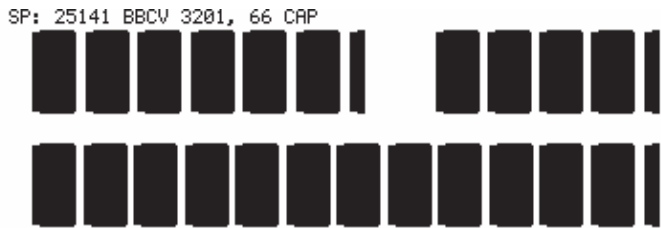

Quote Id: 223509 Seat Plan Spacing Chart

SP: 25141 BBCV 3201, 66 CAP

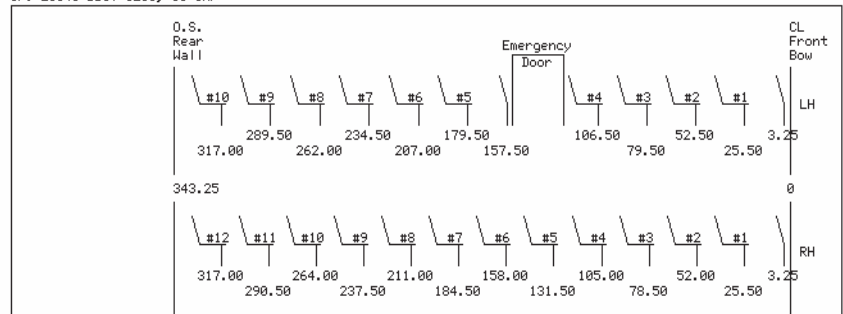

Row	RH Seats	LH Seats
1	39CHVLBR	39CHVLBR
2	39CHVLBR	39CHVLBR
3	39CHVLBR	39CHVLBR
4	39CHVLBR	39CHVLBR
5	39CHVLBR	39CHVLBR
6	39CHVLBR	39CHVLBR
7	39CHVLBR	39CHVLBR
8	39CHVLBR	39CHVLBR
9	39CHVLBR	39CHVLBR
10	39CHVLBR	39CHVLBR
11	39CHVLBR	
12	39CHVLBR	

Dimensions are to center line of front mounting hole.

LH Seat Spacing: 27.00, 27.50
 LH Knee Clearance: 25.24, 25.74
 RH Seat Spacing: 26.50
 RH Knee Clearance: 24.74

BBCV 3201

BBCV3201 SEDSL NEXTGEN LBR

DO NOT SCALE

Capacity	66
Seat Plan #	25141
Wheelbase	273.0

Quote Id: 223510 Body Plan / Seat Plan Information

Body Plan: 5014345

AT A GLANCE

ENGINE- Cummins ISB
FUEL TYPE- Diesel
HP- 250
TRANS- Allison
SIZE- 3201
CAP- 66
WHEELBASE - 273"
ITEM #BB15

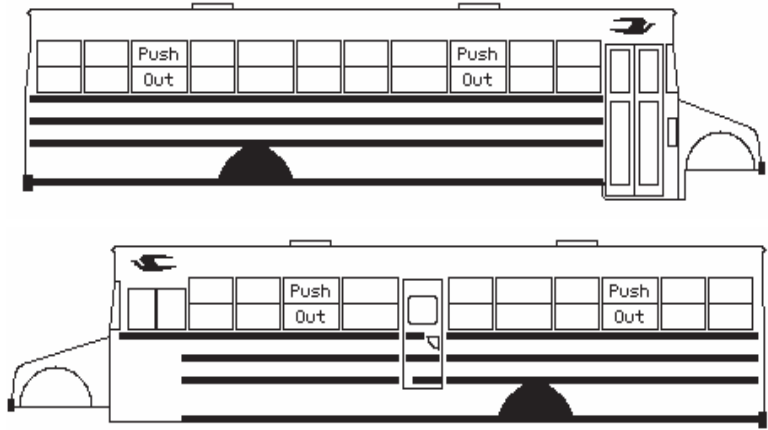

Seat Plan: 25141

SP: 25141 BBCV 3201, 66 CAP



Quote Id: 223510 Seat Plan Spacing Chart

SP: 25141 BBCV 3201, 66 CAP

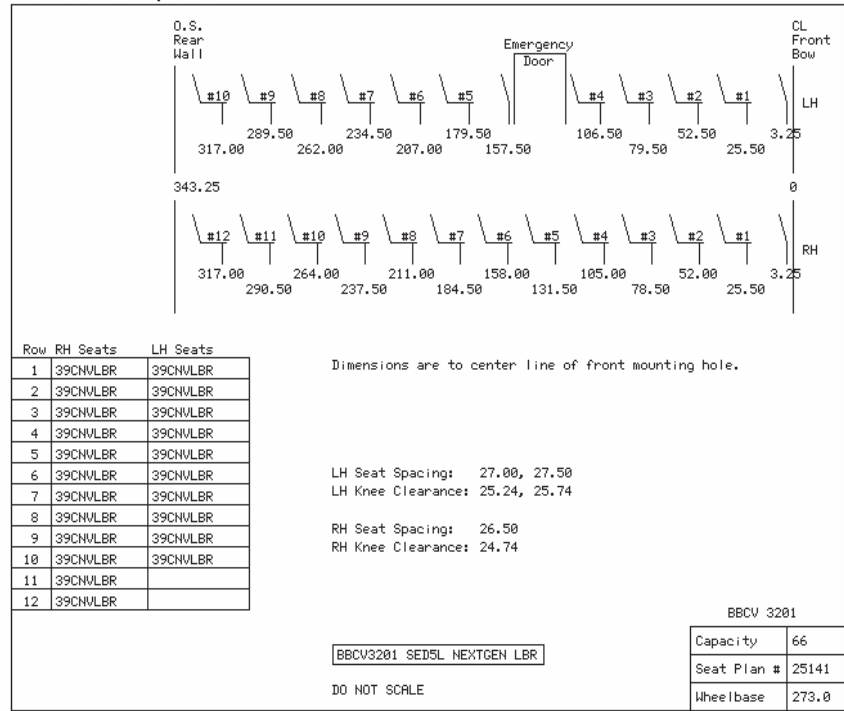

Quote Id: 223511 Body Plan / Seat Plan Information

Body Plan: 5014318

AT A GLANCE

ENGINE- Cummins ISB
FUEL TYPE- Diesel
HP- 220
TRANS- Allison
SIZE- 3310
CAP- 72
WHEELBASE - 273"
ITEM #BB16

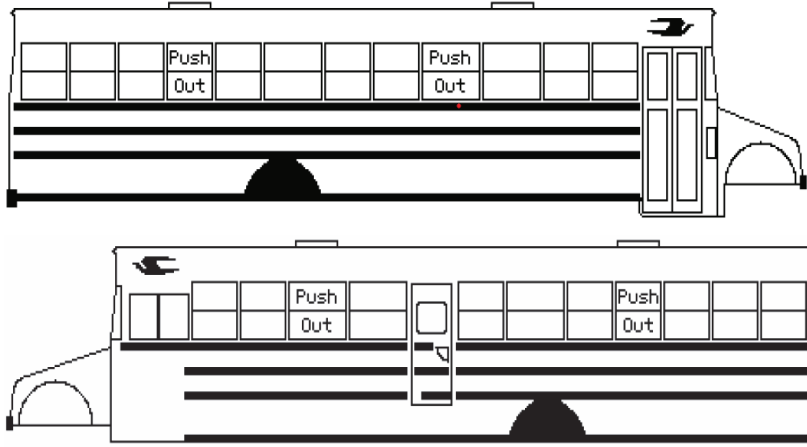

Seat Plan: 30325

SP: 30325 BBCV 3310, 72 CAP



Quote Id: 223511 Seat Plan Spacing Chart

SP: 30325 BBCV 3310, 72 CAP

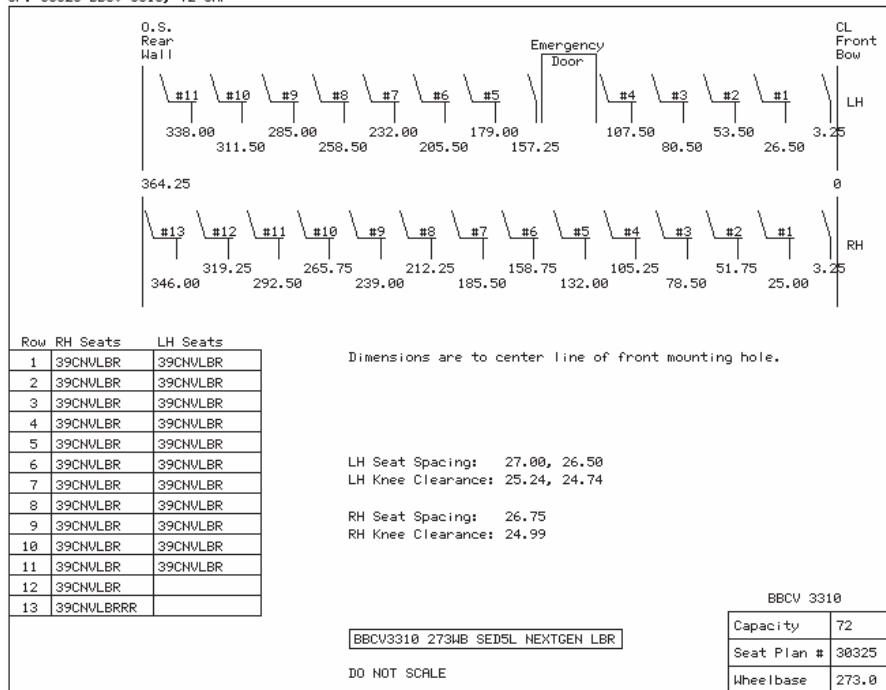



BLUE BIRD

Quote Id: 223512 Body Plan / Seat Plan Information

Body Plan: 5014318

AT A GLANCE

ENGINE- Cummins ISB
FUEL TYPE- Diesel
HP- 250
TRANS- Allison
SIZE- 3310
CAP- 72
WHEELBASE - 273"
ITEM #BB17

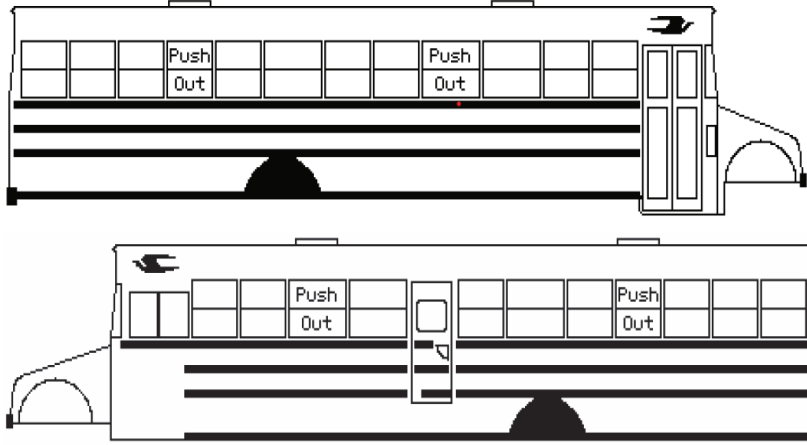

Seat Plan: 30325

SP: 30325 BBCV 3310, 72 CAP



Quote Id: 223512 Seat Plan Spacing Chart

SP: 30325 BBCV 3310, 72 CAP

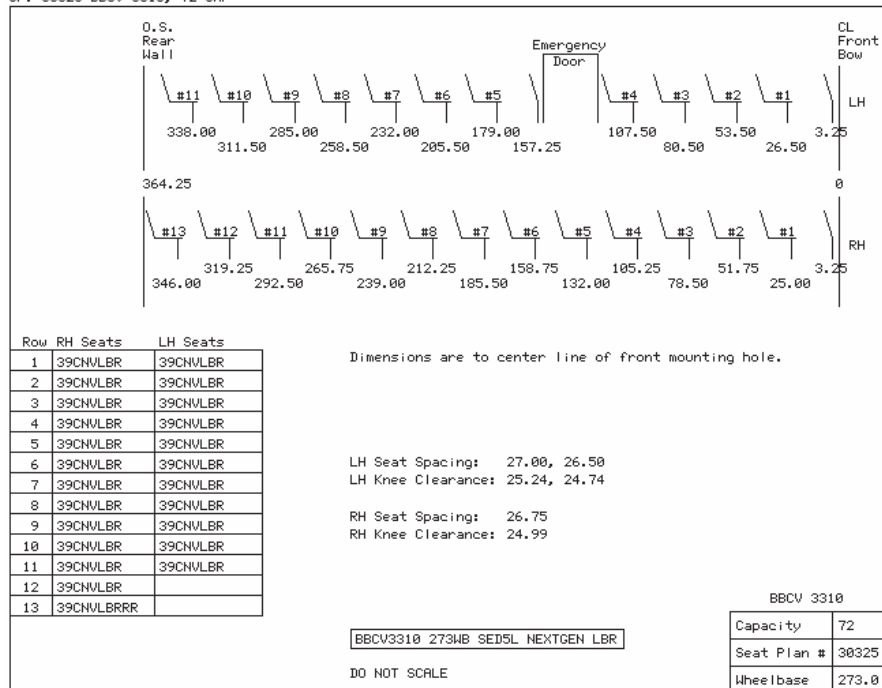



BLUE BIRD®

Quote Id: 223513 Body Plan / Seat Plan Information

Body Plan: 5014550

AT A GLANCE

ENGINE- Cummins ISB
 FUEL TYPE- Diesel
 HP- 250
 TRANS- Allison
 SIZE- 3507
 CAP- 75
 WHEELBASE - 280"
 ITEM #BB18

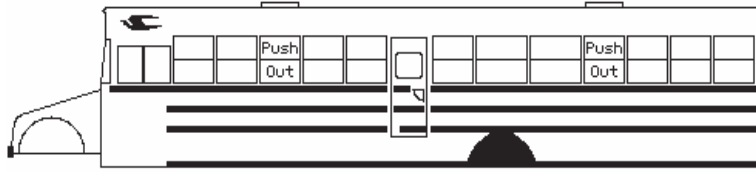
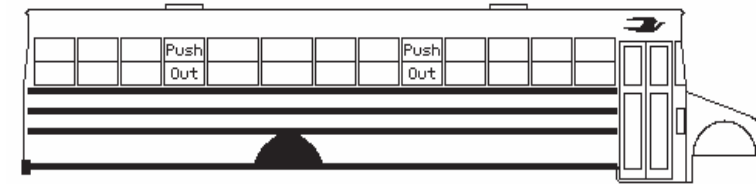

Seat Plan: 27624

SP: 27624 BBCV 3507, 75 CAP



Quote Id: 223513 Seat Plan Spacing Chart

SP: 27624 BBCV 3507, 75 CAP

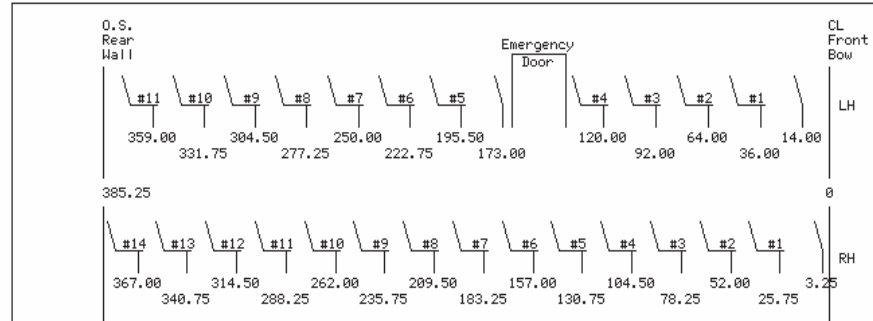

Row	RH Seats	LH Seats
1	39CNVLR	39CNVLR
2	39CNVLR	39CNVLR
3	39CNVLR	39CNVLR
4	39CNVLR	39CNVLR
5	39CNVLR	39CNVLR
6	39CNVLR	39CNVLR
7	39CNVLR	39CNVLR
8	39CNVLR	39CNVLR
9	39CNVLR	39CNVLR
10	39CNVLR	39CNVLR
11	39CNVLR	39CNVLR
12	39CNVLR	
13	39CNVLR	
14	39CNVLR	

BBCV3507 SED6L NG LBR*REL BAR*SPCL RR*

DO NOT SCALE

BBCV 3507	
Capacity	75
Seat Plan #	27624
Wheelbase	280.0

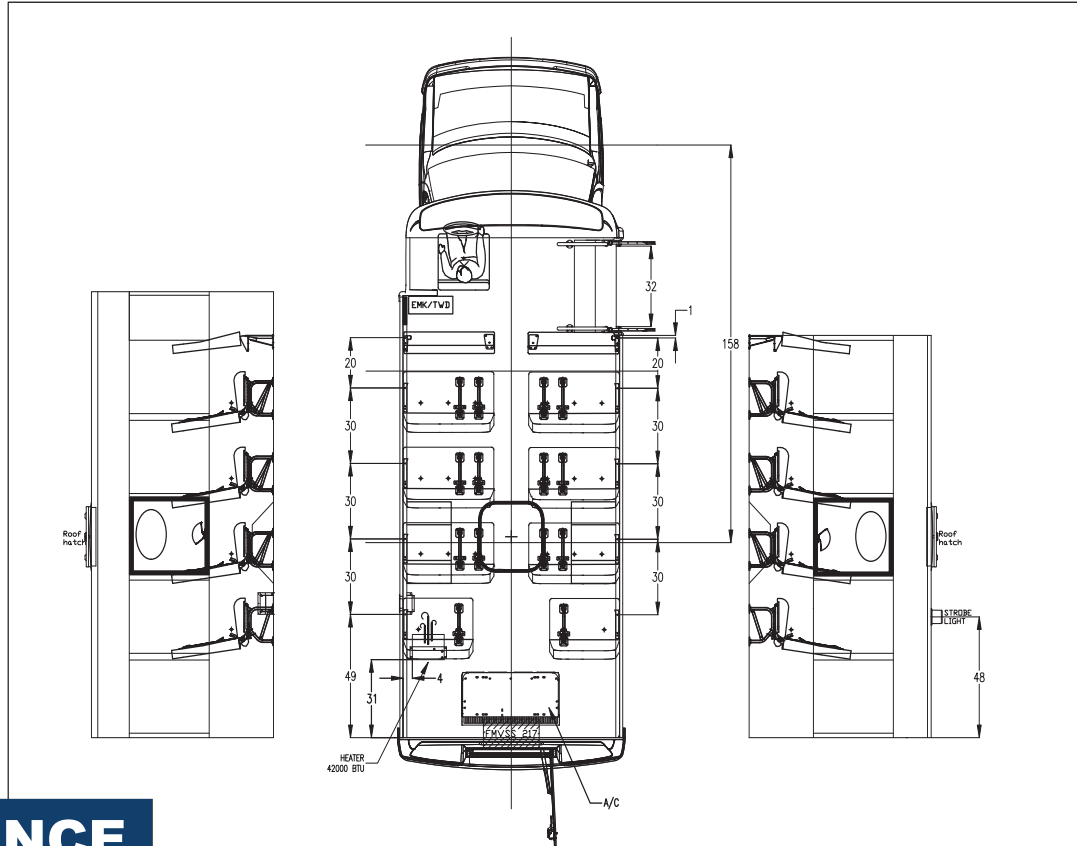

AT A GLANCE

BODY- Micro Bird
ENGINE- Ford
FUEL TYPE- Propane
HP- 262
TRANS- Ford
CAP- 22
WHEELBASE - 158"
ITEM #BB19

SEAT	DIM.	SIDE	QTY
S3	39	LH	3
S3	30	LH	1
S3	39	RH	3
S3	30	LH	1

Seat spacing = See drawing D.O.D.: 32"
APPROVED CONFIGURATIONS
 Total ambulatory passengers: 22 Total wheel chair passengers: 0
 Load cap. (pass. + cargo): **kg **lbs

REV.	2021/05/27	LR	CREATION DRAWING
REV.	YYYY/MM/DD	BY	DESCRIPTION
Stock Number: _____			
Customer Approval: _____		Date: _____	

Drawn by:	
LINE ROY	MODEL: UFH5 2NH WSS
UNIT = INCHES	Drawing no. 053306
SCALE = DO NOT SCALE	
NOTE: Any option added to this floorplan shall be approved by the Corporation Micro Bird Inc. technical department.	



BLUE BIRD®

Quote Id: 223519 | Body Plan / Seat Plan Information

Body Plan: 5014346

AT A GLANCE

ENGINE- Ford
FUEL TYPE- Propane
HP- 320
TRANS- Ford
SIZE- 2311
CAP- 34
WHEELBASE - 189"
ITEM #BB20

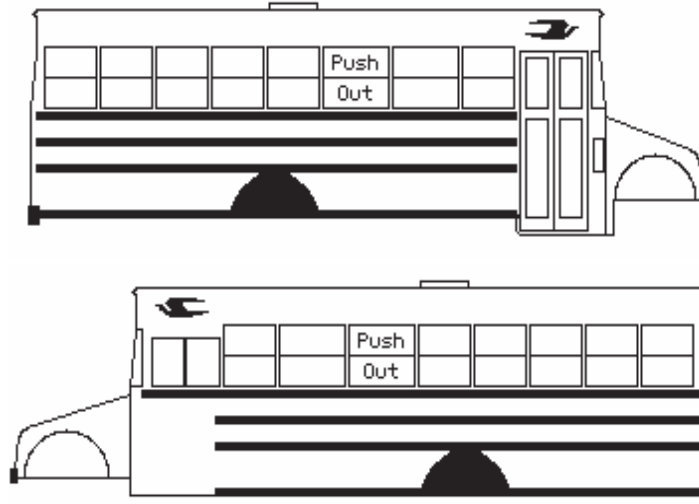

Seat Plan: 23137

SP: 23137 BBCV 2311, 34 CAP



Quote Id: 223519 | Seat Plan Spacing Chart

SP: 23137 BBCV 2311, 34 CAP

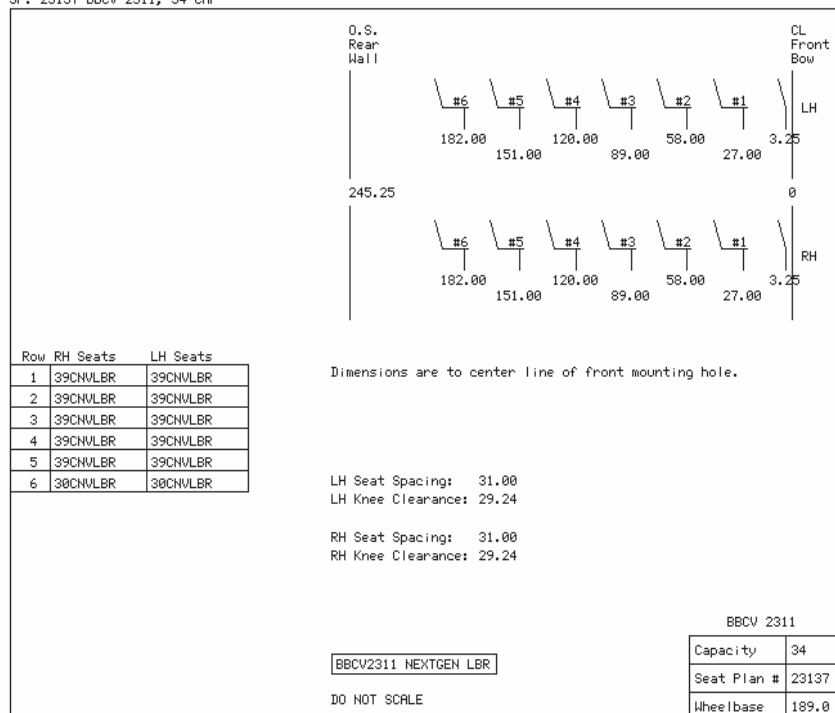

Quote 223519 - 189" WB

Quote Id: 223520 Body Plan / Seat Plan Information

Body Plan: 5014494

AT A GLANCE

ENGINE- Ford
FUEL TYPE- Propane
HP- 320
TRANS- Ford
SIZE- 2610
CAP- 52
WHEELBASE - 217"
ITEM #BB21

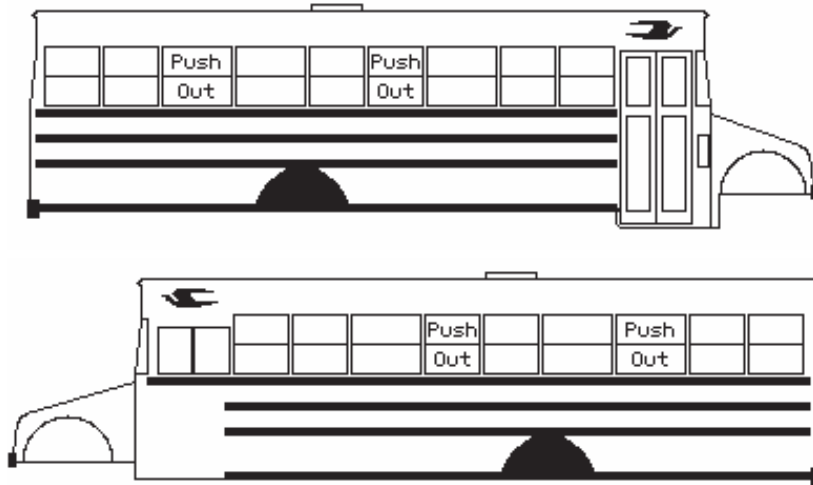

Seat Plan: 23138

SP: 23138 BBCV 2610, 52 CAP



Quote Id: 223520 Seat Plan Spacing Chart

SP: 23138 BBCV 2610, 52 CAP

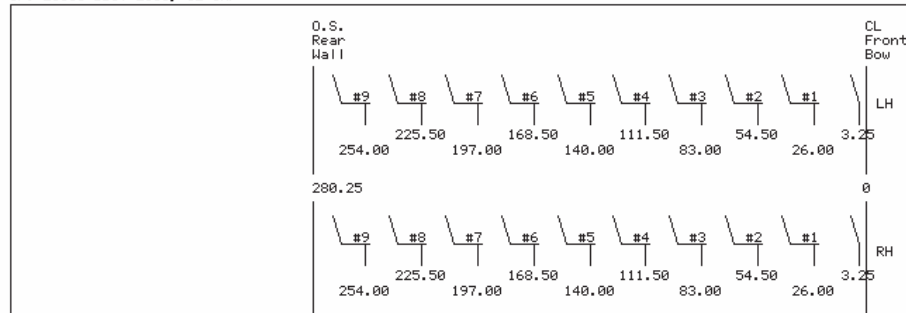

Row	RH Seats	LH Seats
1	39CNVLR	39CNVLR
2	39CNVLR	39CNVLR
3	39CNVLR	39CNVLR
4	39CNVLR	39CNVLR
5	39CNVLR	39CNVLR
6	39CNVLR	39CNVLR
7	39CNVLR	39CNVLR
8	39CNVLR	39CNVLR
9	38CNVLR	38CNVLR

BBCV2610 NEXTGEN LBR

DO NOT SCALE

BBCV 2610	
Capacity	52
Seat Plan #	23138
Wheelbase	217.0

Quote Id: 223521 Body Plan / Seat Plan Information

Body Plan: 5014345

AT A GLANCE

ENGINE- Ford
FUEL TYPE- Propane
HP- 320
TRANS- Ford
SIZE- 3201
CAP- 66
WHEELBASE - 273"
ITEM #BB22

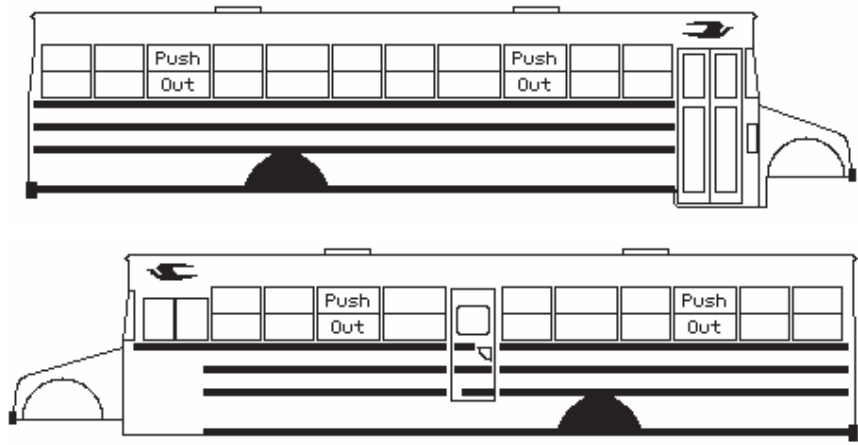

Seat Plan: 25141

SP: 25141 BBCV 3201, 66 CAP



Quote Id: 223521 Seat Plan Spacing Chart

SP: 25141 BBCV 3201, 66 CAP

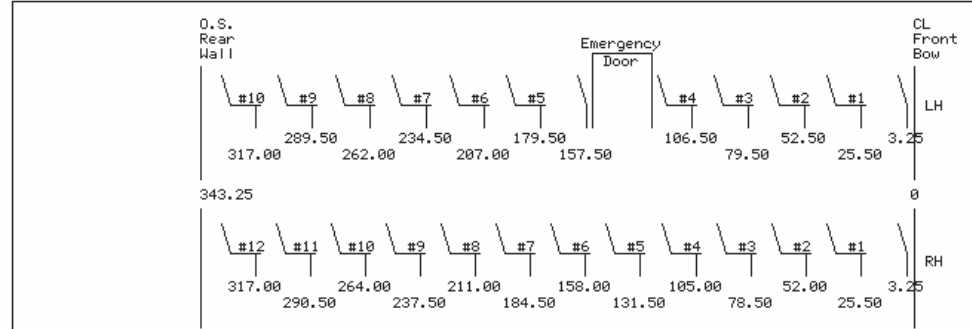

Row	RH Seats	LH Seats
1	39CNVLR	39CNVLR
2	39CNVLR	39CNVLR
3	39CNVLR	39CNVLR
4	39CNVLR	39CNVLR
5	39CNVLR	39CNVLR
6	39CNVLR	39CNVLR
7	39CNVLR	39CNVLR
8	39CNVLR	39CNVLR
9	39CNVLR	39CNVLR
10	39CNVLR	39CNVLR
11	39CNVLR	
12	39CNVLR	

Dimensions are to center line of front mounting hole.

LH Seat Spacing: 27.00, 27.50
 LH Knee Clearance: 25.24, 25.74

RH Seat Spacing: 26.50
 RH Knee Clearance: 24.74

BBCV3201 SED5L NEXTGEN LBR		BBCV 3201	
Capacity	66	Seat Plan #	25141
Wheelbase	273.0		

DO NOT SCALE



BLUE BIRD

Quote Id: 223523 Body Plan / Seat Plan Information

Body Plan: 5014318

AT A GLANCE

ENGINE- Ford
FUEL TYPE- Propane
HP- 320
TRANS- Ford
SIZE- 3310
CAP- 72 EXT
WHEELBASE - 273"
ITEM #BB23

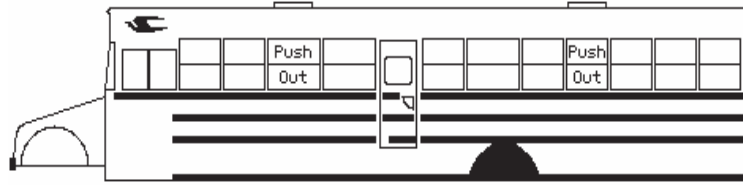
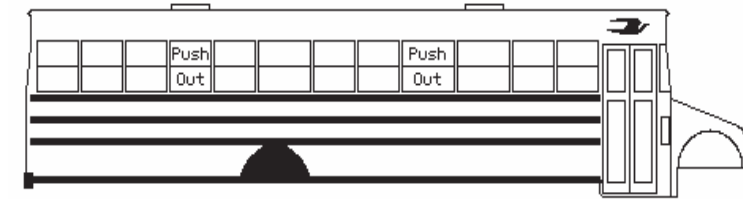

Seat Plan: 30325

SP: 30325 BBCV 3310, 72 CAP



Quote Id: 223523 Seat Plan Spacing Chart

SP: 30325 BBCV 3310, 72 CAP

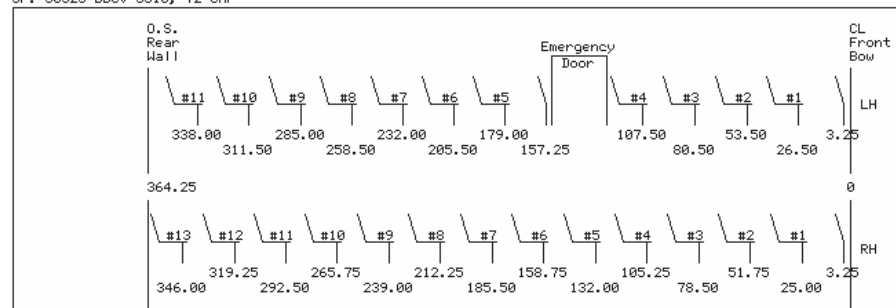

Row	RH Seats	LH Seats
1	39CNVLR	39CNVLR
2	39CNVLR	39CNVLR
3	39CNVLR	39CNVLR
4	39CNVLR	39CNVLR
5	39CNVLR	39CNVLR
6	39CNVLR	39CNVLR
7	39CNVLR	39CNVLR
8	39CNVLR	39CNVLR
9	39CNVLR	39CNVLR
10	39CNVLR	39CNVLR
11	39CNVLR	39CNVLR
12	39CNVLR	
13	39CNVLR	

Dimensions are to center line of front mounting hole.

LH Seat Spacing: 27.00, 26.50
 LH Knee Clearance: 25.24, 24.74
 RH Seat Spacing: 26.75
 RH Knee Clearance: 24.99

BBCV3310 273WB SED5L NEXTGEN LBR

DO NOT SCALE

BBCV 3310	
Capacity	72
Seat Plan #	30325
Wheelbase	273.0

Quote Id: 223524 Body Plan / Seat Plan Information

Body Plan: 5014550

AT A GLANCE

ENGINE- Ford
FUEL TYPE- Propane
HP- 320
TRANS- Ford
SIZE- 3507
CAP- 75 EXT
WHEELBASE - 280"
ITEM #BB24

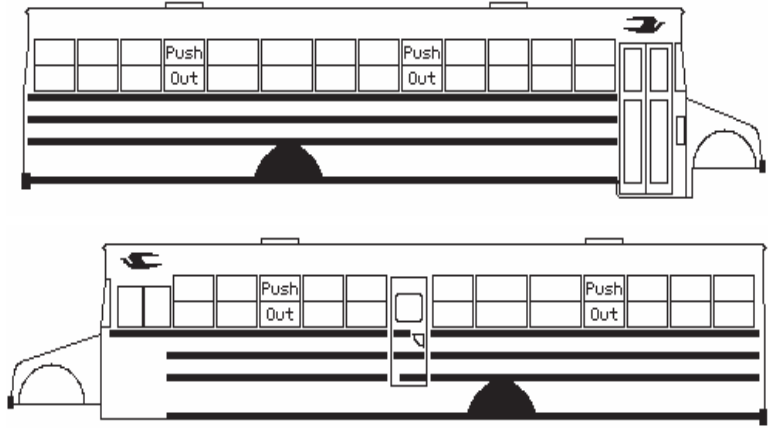

Seat Plan: 27624

SP: 27624 BBCV 3507, 75 CAP



Quote Id: 223524 Seat Plan Spacing Chart

SP: 27624 BBCV 3507, 75 CAP

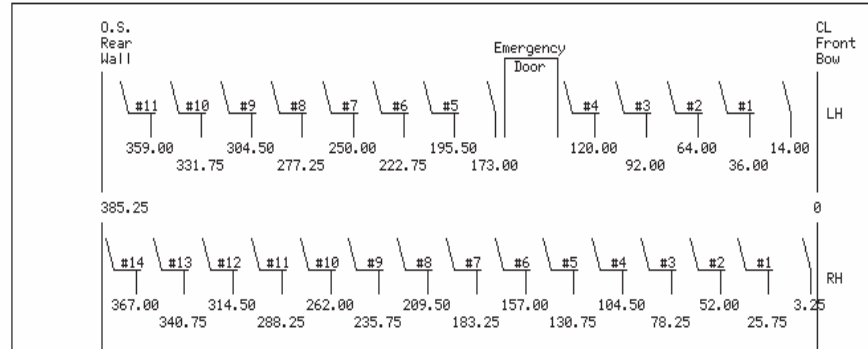

Row	RH Seats	LH Seats
1	39CNVLR	39CNVLR
2	39CNVLR	39CNVLR
3	39CNVLR	39CNVLR
4	39CNVLR	39CNVLR
5	39CNVLR	39CNVLR
6	39CNVLR	39CNVLR
7	39CNVLR	39CNVLR
8	39CNVLR	39CNVLR
9	39CNVLR	39CNVLR
10	39CNVLR	39CNVLR
11	39CNVLR	39CNVLR
12	39CNVLR	
13	39CNVLR	
14	39CNVLR	

Dimensions are to center line of front mounting hole.

LH Seat Spacing: 28.00, 27.50
 LH Knee Clearance: 26.24, 25.74
 RH Seat Spacing: 26.25
 RH Knee Clearance: 24.49

BBCV 3507

BBCV3507 SED6L HG LBR*REL BAR*SPCL RR*

Capacity	75
Seat Plan #	27624
Wheelbase	280.0

DO NOT SCALE

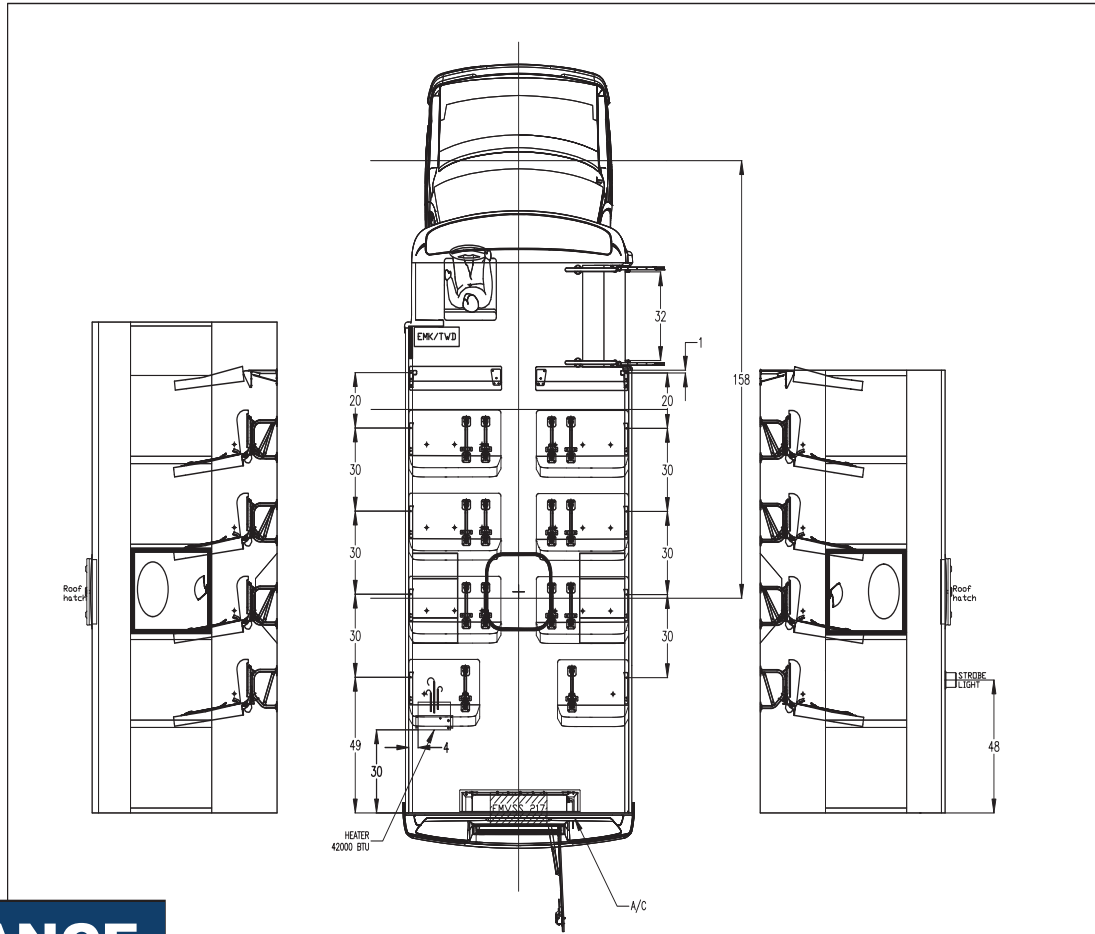

AT A GLANCE

BODY- MicroBird
ENGINE- Borg-Warner Remy
FUEL TYPE- Electric
HP- Electric
TRANS- Electric
CAP- 22
WHEELBASE - 158"
ITEM #BB25

SEAT	DIM.	SIDE	QTY
S3	39	LH	3
S3	30	LH	1
S3	39	RH	3
S3	30	LH	1

Seat spacing = See drawing D.O.D.: 32"

APPROVED CONFIGURATIONS

Total ambulatory passengers : 22	Total wheel chair passengers : 2
Load cap. (pass. + cargo) : **kg **lbs	

REV.	2021/05/27	LR	CREATION DRAWING
REV.	YYYY/MM/DD	BY	DESCRIPTION
Stock Number:		Customer Approval:	
Date:		Date:	

Drawn by : LINE ROY	MICRO BIRD *GARDIN
MODEL: UFH5 2NH WSS	Drawing no. 053358
UNIT = INCHES SCALE = DO NOT SCALE	
NOTE: Any option added to this floorplan shall be approved by the Corporation Micro Bird inc. technical department.	



BLUE BIRD

Quote Id: 223601 Body Plan / Seat Plan Information

Body Plan: 5015525

AT A GLANCE

ENGINE- Cummins
FUEL TYPE- Electric
HP- Electric
TRANS- Electric
SIZE- 3310
CAP- 72
WHEELBASE - 273"
ITEM #BB26

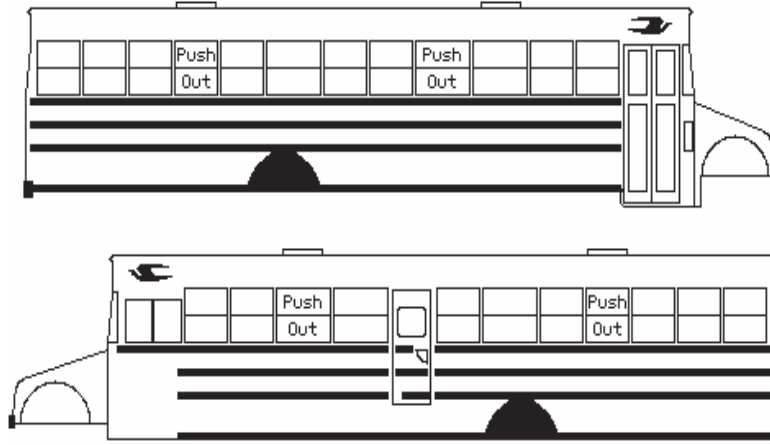

Seat Plan: 30325

SP: 30325 BBCV 3310, 72 CAP



Quote Id: 223601 Seat Plan Spacing Chart

SP: 30325 BBCV 3310, 72 CAP

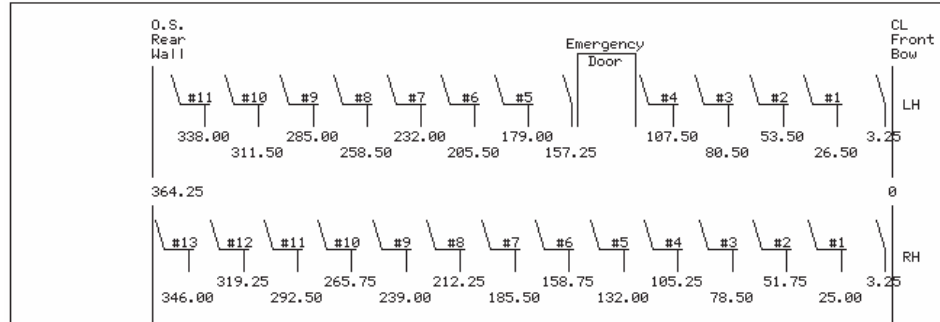

Row	RH Seats	LH Seats
1	39CNVLR	39CNVLR
2	39CNVLR	39CNVLR
3	39CNVLR	39CNVLR
4	39CNVLR	39CNVLR
5	39CNVLR	39CNVLR
6	39CNVLR	39CNVLR
7	39CNVLR	39CNVLR
8	39CNVLR	39CNVLR
9	39CNVLR	39CNVLR
10	39CNVLR	39CNVLR
11	39CNVLR	39CNVLR
12	39CNVLR	
13	39CNVLR	

Dimensions are to center line of front mounting hole.

LH Seat Spacing: 27.00, 26.50
 LH Knee Clearance: 25.24, 24.74
 RH Seat Spacing: 26.75
 RH Knee Clearance: 24.99

BBCV 3310

BBCV3310 273WB SED5L NEXTGEN LBR

DO NOT SCALE

Capacity	72
Seat Plan #	30325
Wheelbase	273.0



Quote Id: 223553 Body Plan / Seat Plan Information

Body Plan: 5011609

AT A GLANCE

ENGINE- Cummins ISB
FUEL TYPE- Diesel
HP- 250
TRANS- Allison
SIZE- 4004
CAP- 78
WHEELBASE - 232"
ITEM #BB27

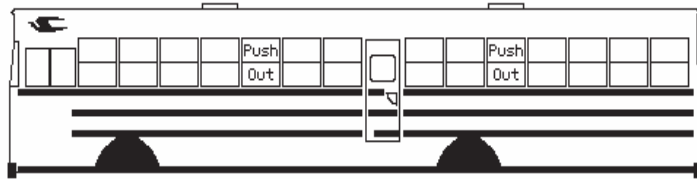
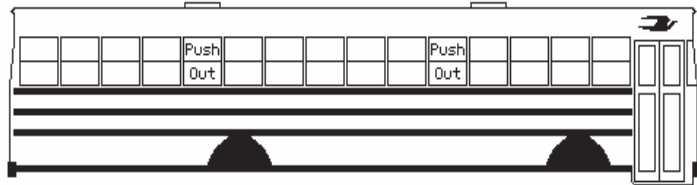

Seat Plan: 23143

SP: 23143 T3FE 4004, 78 CAP



Quote Id: 223553 Seat Plan Spacing Chart

SP: 23143 T3FE 4004, 78 CAP

O.S. Rear Wall Emergency Door CL Front Bow

LH RH

400.00 370.00 340.00 310.00 280.00 250.00 228.00 177.75 148.75 119.75 90.75 61.75 32.75 12.87

427.78

399.75 372.50 345.25 318.00 290.75 263.50 236.25 209.00 181.75 154.50 127.25 100.00 72.75 45.00

Row	RH Seats	LH Seats
1	39CNVLR	39CNVLR
2	39CNVLR	39CNVLR
3	39CNVLR	39CNVLR
4	39CNVLR	39CNVLR
5	39CNVLR	39CNVLR
6	39CNVLR	39CNVLR
7	39CNVLR	39CNVLR
8	39CNVLR	39CNVLR
9	39CNVLR	39CNVLR
10	39CNVLR	39CNVLR
11	39CNVLR	39CNVLR
12	39CNVLR	39CNVLR
13	39CNVLR	
14	39CNVLR	

Dimensions are to center line of front mounting hole.

LH Seat Spacing: 29.00, 30.00
 LH Knee Clearance: 27.24, 28.24

RH Seat Spacing: 27.25
 RH Knee Clearance: 25.49

T3FE 4004

Capacity	78
Seat Plan #	23143
Wheelbase	232.0

T3FE4004 SED8L NEXTGEN LBR

DO NOT SCALE



Quote Id: 223556 Body Plan / Seat Plan Information

Body Plan: 5013675

AT A GLANCE

ENGINE- Cummins ISB
FUEL TYPE- Diesel
HP- 250
TRANS- Allison
SIZE- 4006
CAP- 78
WHEELBASE - 273"
ITEM #BB28

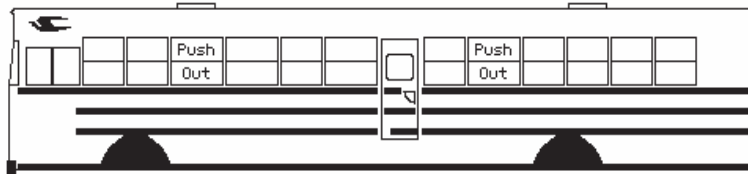
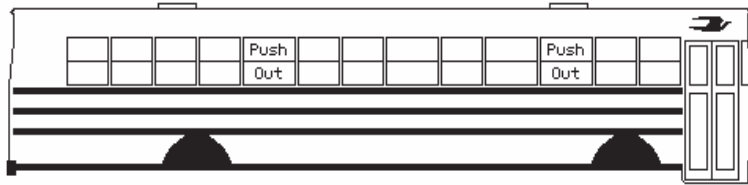

Seat Plan: 25142

SP: 25142 T3RE 4006, 78 CAP



Quote Id: 223556 Seat Plan Spacing Chart

SP: 25142 T3RE 4006, 78 CAP

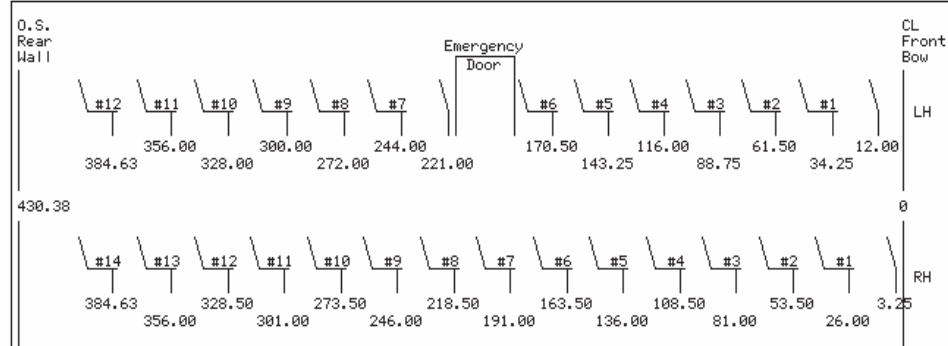

Row	RH Seats	LH Seats
1	39CNVLBR	39CNVLBR
2	39CNVLBR	39CNVLBR
3	39CNVLBR	39CNVLBR
4	39CNVLBR	39CNVLBR
5	39CNVLBR	39CNVLBR
6	39CNVLBR	39CNVLBR
7	39CNVLBR	39CNVLBR
8	39CNVLBR	39CNVLBR
9	39CNVLBR	39CNVLBR
10	39CNVLBR	39CNVLBR
11	39CNVLBR	39CNVLBR
12	39CNVLBR	39CNVLBRDAV
13	39CNVLBR	
14	39CNVLBRDAV	

Dimensions are to center line of front mounting hole.

LH Seat Spacing: 27.25, 28.00
 LH Knee Clearance: 25.49, 26.24

RH Seat Spacing: 27.50
 RH Knee Clearance: 25.74

T3RE4006 SED7L NEXTGEN LBR

DO NOT SCALE

T3RE 4006	
Capacity	78
Seat Plan #	25142
Wheelbase	273.0



Quote Id: 223602 Body Plan / Seat Plan Information

Body Plan: 5013682

AT A GLANCE

ENGINE- Cummins
FUEL TYPE- Electric
HP- Electric
TRANS- Electric
SIZE- 4006
CAP- 78
WHEELBASE - 273"
ITEM #BB29

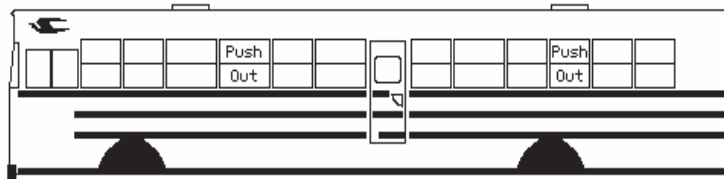
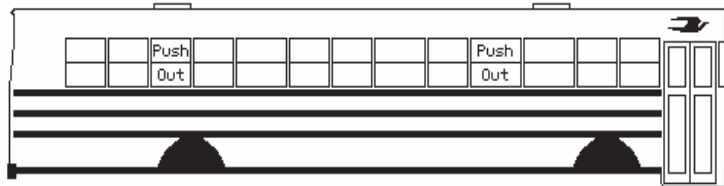

Seat Plan: 25142

SP: 25142 T3RE 4006, 78 CAP



Quote Id: 223602 Seat Plan Spacing Chart

SP: 25142 T3RE 4006, 78 CAP

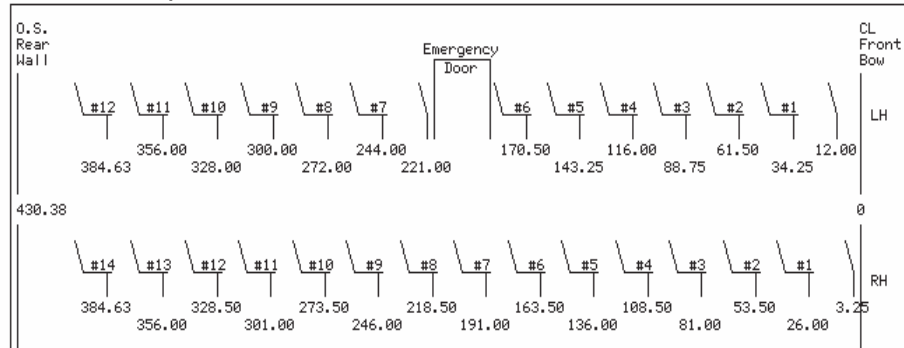

Row	RH Seats	LH Seats
1	39CNVLBR	39CNVLBR
2	39CNVLBR	39CNVLBR
3	39CNVLBR	39CNVLBR
4	39CNVLBR	39CNVLBR
5	39CNVLBR	39CNVLBR
6	39CNVLBR	39CNVLBR
7	39CNVLBR	39CNVLBR
8	39CNVLBR	39CNVLBR
9	39CNVLBR	39CNVLBR
10	39CNVLBR	39CNVLBR
11	39CNVLBR	39CNVLBR
12	39CNVLBR	39CNVLBRDAV
13	39CNVLBR	
14	39CNVLBRDAV	

Dimensions are to center line of front mounting hole.

LH Seat Spacing: 27.25, 28.00
 LH Knee Clearance: 25.49, 26.24

RH Seat Spacing: 27.50
 RH Knee Clearance: 25.74

T3RE4006 SED7L NEXTGEN LBR

DO NOT SCALE

T3RE 4006	
Capacity	78
Seat Plan #	25142
Wheelbase	273.0



Kentucky Department of Education
2024 IC Bus School Bus Purchase Authorization

The _____ Board of Education, located in _____ Kentucky, on the ____ day of _____, 20____, in a legally called and constituted meeting, voted to purchase school buses through the Commonwealth of Kentucky contract price procedure.

This Board of Education took this official action to authorize the Chief State School Officer to procure 2024 school buses. This action, as spread upon the minutes of the meeting of this Board of Education on the above date, should be construed as evidence of obligation of this Board of Education to purchase the above school buses through the Commonwealth of Kentucky contract agreements established in accordance with statutory authority.

Signed

_____, Secretary
_____, Superintendent
of the _____ Board of Education
On the ____ day of _____, 20_____.

BODY SIDE NUMBERS: Indicate the body side number the Board of Education wants painted on the side of the body of each school bus. Match body side number to individual item numbers. Example: Item 1 - Side number - 5, 6, 7, 8

Due to supply chain issues, current lead times for school bus completion is 270 days from order submittal date.
Attach additional information if necessary.



IC Bus School Bus Options

Special Needs Diesel School Buses

Item #	Quantity	Bus Type	Capacity	Engine	Chassis	HP	Transmission	Wheel Base	Rear Axle Overhang	Base Purchase Price
IC-01		C	34	Cummins B6.7	International	220	Allison 2500PTS	170	93	\$130,495
IC-02		C	52	Cummins B6.7	International	220	Allison 2500PTS	218	127	\$134,695
IC-03		C	52	Cummins B6.7	International	250	Allison 2500PTS	218	127	\$135,696
IC-04		C	66	Cummins B6.7	International	220	Allison 2500PTS	276	148	\$142,295
IC-05		C	66	Cummins B6.7	International	250	Allison 2500PTS	276	148	\$143,296
IC-06		C	66	Cummins B6.7	International	220	Allison 3000PTS	276	148	\$147,395
IC-07		C	66	Cummins B6.7	International	250	Allison 3000PTS	276	148	\$148,396

Type C – Diesel School Buses

Item #	Quantity	Bus Type	Capacity	Engine	Chassis	HP	Transmission	Wheel Base	Rear Axle Overhang	Base Purchase Price
IC-08		C	34	Cummins B6.7	International	220	Allison 2500PTS	170	93	\$122,995
IC-09		C	52	Cummins B6.7	International	220	Allison 2500PTS	218	127	\$126,895
IC-10		C	52	Cummins B6.7	International	250	Allison 2500PTS	218	127	\$127,896
IC-11		C	66	Cummins B6.7	International	220	Allison 2500PTS	276	140	\$131,195
IC-12		C	66	Cummins B6.7	International	250	Allison 2500PTS	276	140	\$132,196
IC-13		C	72	Cummins B6.7	International	220	Allison 2500PTS	276	158	\$131,799
IC-14		C	72	Cummins B6.7	International	250	Allison 2500PTS	276	158	\$132,800
IC-15		C	66	Cummins B6.7	International	220	Allison 3000PTS	276	140	\$134,095
IC-16		C	66	Cummins B6.7	International	250	Allison 3000PTS	276	140	\$135,096
IC-17		C	72	Cummins B6.7	International	220	Allison 3000PTS	276	158	\$135,595
IC-18		C	72	Cummins B6.7	International	250	Allison 3000PTS	276	158	\$136,596



Type C – Electric School Buses

Item #	Quantity	Bus Type	Capacity	Engine	Chassis	HP	Transmission	Wheel Base	Rear Axle Overhang	Base Purchase Price
IC - 19		C	52	255 KW	International	342	210 KWh	218	127	\$394,999
IC - 20		C	72	255 KW	International	342	210 KWh	276	158	\$399,999



IC Bus Optional School Bus Products

Radio Options

Item #	Bus Type	Description	Price
ICO-01	C - 34/52 PASS	AM/FM/P.A. with four interior speakers and outside speaker	\$513.00
ICO-02	C - 66/72 PASS	AM/FM/P.A. with six interior speakers and outside speaker	\$551.00

Camera Options

Item #	Bus Type	Description	Price
ICO-03	C	Seon DH6H500G 6 channel video system with 1 camera head and 500 GB hard drive	\$2,407.00
ICO-04	C	Seon Stop Arm Camera (installed with system above)	\$590.00
ICO-05	C	Seon Additional camera head (installed with system above)	\$445.00
ICO-06	C	Seon Pedestal for Forward facing (windshield) camera	\$125.00
ICO-07	C	Seon Sensor Harness, Event Marker, GPS Antenna	\$322.00
ICO-08	C	Seon DH8H1T0 - M 8 channel video system with 1 camera head and 1 TB hard drive	\$3,089.00
ICO-09	C	Seon Wi-Fi Antenna for video download	\$244.00
ICO-10	C	REI HD6 6 channel video system with 1 camera head and 500 GB hard drive	\$2,378.00
ICO-11	C	REI Additional camera head (installed with system above)	\$305.00
ICO-12	C	REI Event Marker installed with a new video system	\$135.00
ICO-13	C	REI Sensor Harness installed with a new video system	\$195.00
ICO-14	C	REI - Add Stop Arm camera to a new HD6 video system with 4 camera heads	\$717.00
ICO-15	C	REI - Add Stop Arm camera to a new HD6 video system with 1, 2, or 3 camera heads	\$459.00
ICO-16	C	REI HD5 12 channel video system with 1 camera head and 500 GB hard drive	\$3,203.00
ICO-17	C	REI Pedestal mount for forward-facing (windshield) camera	\$125.00



Luggage Options

NOTE: Luggage Boxes will be limited to the right-hand side with air conditioning. Availability will be limited on special needs school buses due to the wheelchair track.

Item #	Bus Type	Description	Price
ICO-18	C - 52 PASS	Left Center 91" x 24" x 18" (47EVB)	\$1,050.00
ICO-19	C - 52 PASS	Right Center 66" x 24" x 18" (47ESX)	\$870.00
ICO-20	C - 66 PASS	Left Center 114" x 24" x 18" (47EVV)	\$1,182.00
ICO-21	C - 66 PASS	Right Center 114" x 24" x 18" (47EVT)	\$1,182.00
ICO-22	C - 66 PASS	Right Rear 36" x 20" x 18" (47GAG)	\$662.00
ICO-23	C - 72 PASS	Left Center 114" x 24" x 18" (47EVV)	\$1,182.00
ICO-24	C - 72 PASS	Right Center 114" x 24" x 18" (47EVT)	\$1,182.00
ICO-25	C - 72 PASS	Right Rear " x 20" x 18" (47GAG)	\$700.00

Air Conditioning Options

Item #	Bus Type	Description	Price
ICO-26	C - Diesel	85,000 BTU for 34 passenger size	\$9,644.00
ICO-27	C - Diesel	120,000 BTU for 52 - 72 passenger size	\$10,991.00
ICO-28	C - Electric	120,000 BTU for 52 - 72 passenger size	\$25,450.00

Tire Options

Item #	Bus Type	Description	Price
ICO-29	C	16 ply Goodyear instead of 14 ply Goodyear	\$1,437.00
ICO-30	C	14 ply Goodyear Fuel Max	Standard
ICO-31	C	14 ply Michelin instead of 14 ply Goodyear	\$216.00
ICO-32	C	14 ply Bridgestone R268	\$66.00
ICO-33	C	16 ply Continental HS3+	\$288.00



Fuel Tank Options

Item #	Bus Type	Description	Price
ICO-34	C Diesel - (66 or 72 PASS)	100-gallon diesel fuel tank instead of 65-gallon tank	\$667.00

Warranty Options

Item #	Bus Type	Description	Price
ICO-35	C	Extended Tow Warranty - 3 yrs/unlimited miles (\$550 maximum per incident) - N/A for ELECTRIC BUS	\$2,000.00
ICO-36	C	Extended Tow Warranty - 3 yrs/unlimited miles (\$1,100 maximum per incident) - N/A for ELECTRIC BUS	\$2,500.00

Seating Options

Item #	Bus Type	Description	Price
ICO-37	C	U.C.R.A. added to seat (per seat)	\$80.00
ICO-38	C	39" IMMI Child Restraint Seat instead of 39" regular seat (per seat)	\$828.00
ICO-39	C	39" seat with 3-point seatbelts (per seat)	\$597.00
ICO-40	C	30" IMMI Child Restraint Seat with 3-point instead of 30" with 3-point (per seat)	\$1,253.00
ICO-41	C	30" Track-mounted seat with 3-point belts (per seat)	\$1,184.00
ICO-42	C	30" Track-mounted Barrier	\$417.00
ICO-43	C	Delete one Wheelchair Position	\$356.00
ICO-44	C	Add One Wheelchair Position	\$671.00

Miscellaneous Options

Item #	Bus Type	Option Type	Description	Price
ICO-45	C	Adjustable Pedals	Adjustable Pedals (includes tilt/tele steering column)	\$919.00
ICO-46	C	Brakes	Air Disc Brakes instead of Air Drum Brakes	\$1,733.00
ICO-47	C	Collision Mitigation	Bendix Wingman Advanced (base level CM)	\$1,267.00
ICO-48	C	Collision Mitigation	Bendix Wingman Fusion (includes camera and front sensor)	\$3,006.00
ICO-49	C	Engine Brake	Engine Brake for Cummins B6.7	\$148.00
ICO-50	C - 34 PASS	Floor	5/8" Marine Grade plywood subfloor with sealed edges (47SCK)	\$973.00
ICO-51	C - 52 PASS	Floor	5/8" Marine Grade plywood subfloor with sealed edges (47ANW)	\$1,089.00



Item #	Bus Type	Option Type	Description	Price
ICO-52	C – 66/72 PASS	Floor	5/8" Marine Grade plywood subfloor with sealed edges (47SUB)	\$1,220.00
ICO-53	C	Floor	One-piece floor covering material (48UWV)	\$701.00
ICO-54	C	Interior	Barrier Cover with Pouch (48BDG)	\$90.00
ICO-55	C	Interior	Trash Can in Driver Area	\$142.00
ICO-56	C	Interior	Driver's Dome Light with separate switch	\$52.00
ICO-57	C	Interior	Power Outlet - 12 volt for GPS	Standard
ICO-58	C	Mirrors	Rosco Eurostyle Mirrors instead of Open View ES	\$299.00
ICO-59	C	Mirrors	Heated Crossover Mirrors	\$99.00
ICO-60	C	Special Needs	Sure-Lok GO-2 Oxygen Cylinder Holder	\$425.00
ICO-61	C	Steering Column	Tilt/Telescopic Steering Column (005710)	\$450.00
ICO-62	C	Tow Hooks	Front Tow Hooks, Two (001570)	\$119.00
ICO-63	C	Tow Hooks	Rear Tow Hooks, Two (01WRP)	\$106.00
ICO-64	C – 34 PASS	Windows	Tinted Windows (non-special needs) (48BTV)	\$515.00
ICO-65	C - 52 PASS	Windows	Tinted Windows (non-special needs) (48BTX)	\$629.00
ICO-66	C - 66/72 PASS	Windows	Tinted Windows (non-special needs) (48BUB)	\$730.00
ICO-67	C	Dash Cluster	Premium Dash Cluster with 5" color display	\$488.00
ICO-68	C	Park Brake	Bendix IntelliPark	\$500.00
ICO-69	C	Engine Controls	Cruise Control	\$50.00
ICO-70	C	Headlights	LED Headlights (08XPA)	\$888.00



Bluegrass International Contact Information

Name	Title	Telephone Number	Email Address
Mark Cahill	Sales Director	(502)-570-5230	mcahill@bluegrasstrucks.com

AT A GLANCE

Engine - Cummins
 Fuel Type- Diesel
 HP- 220
 Trans - 2500 PTS
 Size - 19'11"
 Capacity - 14
 Wheelbase - 170
 Item # - IC - 01

BODY PLAN

WHEELBASE 170"

PB11000, 19 FT. 11 IN., CAP 14

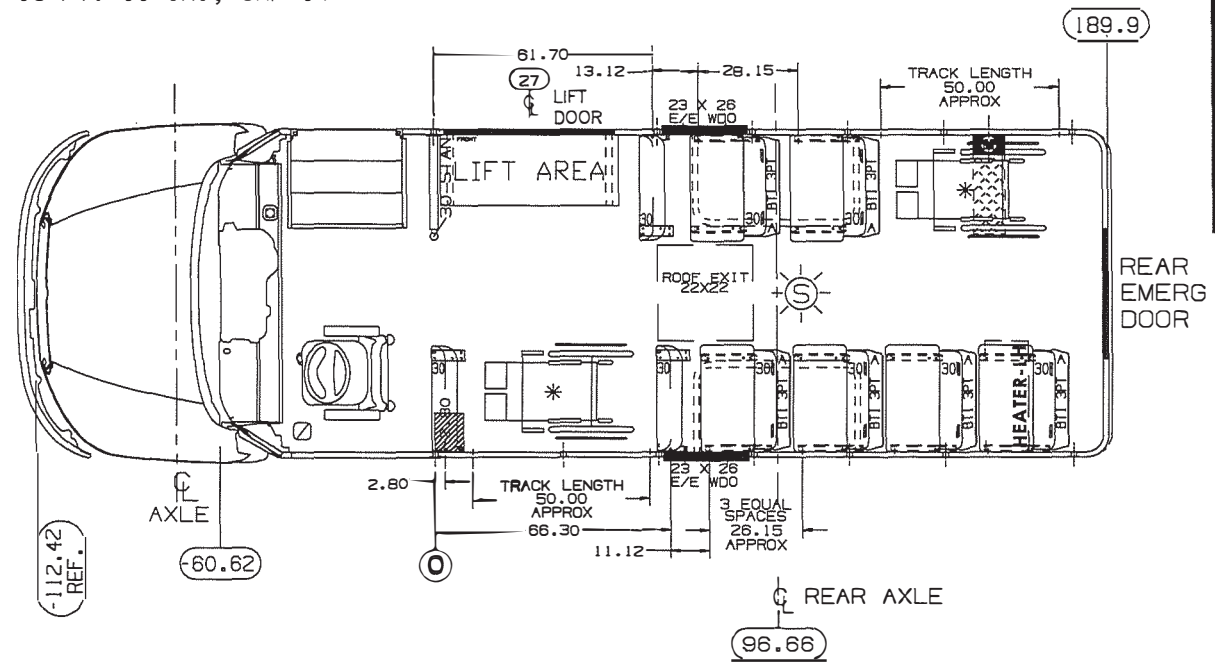

* 100" : TOTAL TRACK LENGTH (APPROXIMATELY)

♦ NOTE:
 IT IS THE SELLING DEALER'S RESPONSIBILITY TO ENSURE THAT ANY WHEELCHAIR TIE - DOWN SYSTEM SPECIFIED AND DEPICTED ON THIS DRAWING MEETS ALL DESTINATION STATE SPECIFICATIONS AND TO ALSO ENSURE THAT THE WHEELCHAIRS CAN BE PLACED AND REMOVED WITH RESPECT TO: SEATS, K/O'S, SIDE EMERG DOORS, HEATERS, LIFTS, WHEELHOUSES, ETC..
 POSSESSION OF THIS PRINT DOES NOT IN ANY WAY OBLIGATE IC CORP. TO BUILD THE UNIT SHOWN.
 WC TRACK SHOWN IS FOR REFERENCE ONLY.

THIS UNIT CONFORMS TO APPLICABLE FMVSS

THIS DOCUMENT IS IN ACCORDANCE WITH ASME Y14.5M-1994 AS AMENDED BY THE INTERNATIONAL TRUCK DIVISION DIMENSIONING AND TOLERANCING STANDARD-2000.

50000/49000			INTERNATIONAL TRUCK AND ENGINE CORPORATION	
	INTERNATIONAL CONFIDENTIAL PROPRIETARY			
	DOD			
	REFERENCE		APPROX. MASS (WEIGHT)	
	LINEAR MEASURE: mm <input type="checkbox"/> in <input checked="" type="checkbox"/>		ROUGH PART	
	TRADE SPECIFIED DIM TOLERANCES ARE		FINISH PART	
	ONE PLACE (1.30)	±.15	±.08	INTERNAL CONTROL
	TWO PLACE (1.300)	±0.18	±.03	
	THREE PLACE (1.3000)	±0.25	±0.10	TRADE SPECIFIED DIMENSIONS
	ANGLES	±1°		
NAME BODY PLAN PB11000			CONTROL E 50	
NAME TYPING/REVISION			VERSION E	
DESIGNER LUOMACH	DATE	APPROVER	DATE	
DATE	APPROVED	PART NAME CODE	PART TYPE CODE	
DATE	PART NO.	SCALE NONE	SHEET 4	
RELEASE NO.	BLUE-196		SHEET 01	

BODY PLAN

WHEELBASE 218"

PB11000, 26 FT. 8 IN., CAP 20

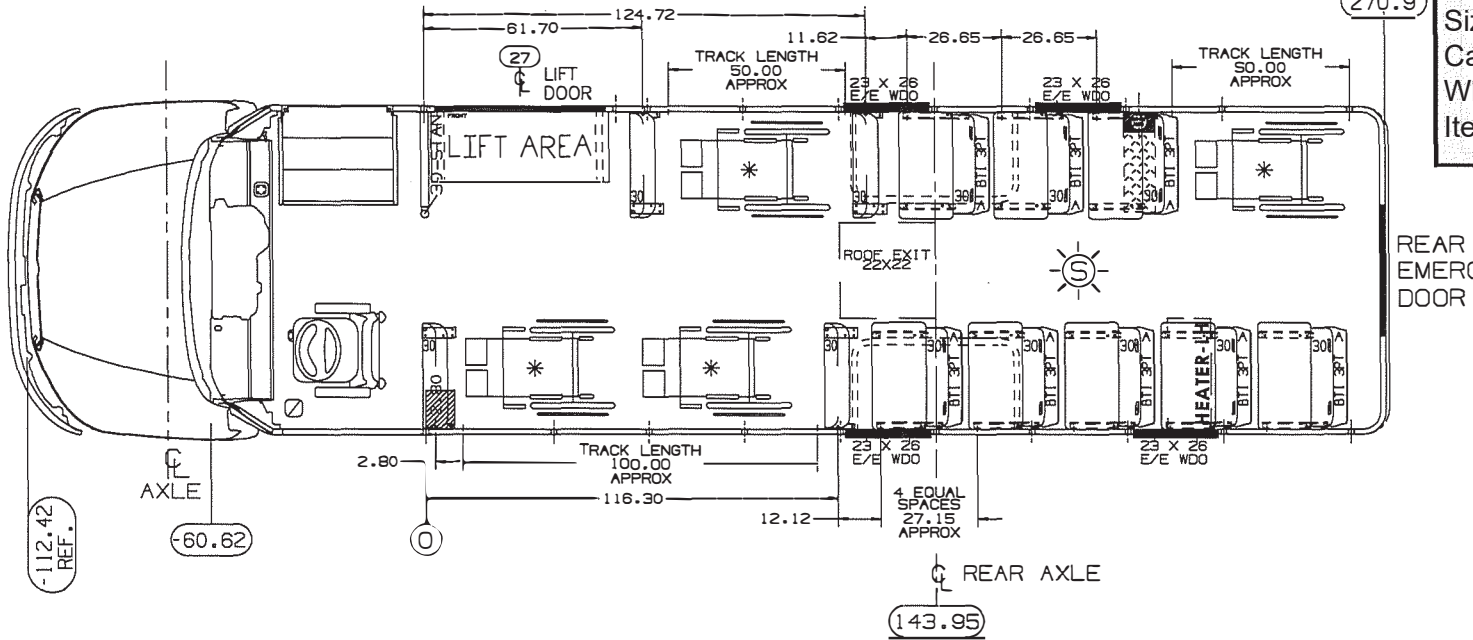

AT A GLANCE

Engine - Cummins
 Fuel Type - Diesel
 HP - 220 or 250
 Trans - 2500 PTS
 Size 26' 8"
 Capacity- 20
 Wheelbase- 218
 Item # IC-02, IC-03

* NOTE:
 IT IS THE SELLING DEALER'S RESPONSIBILITY TO ENSURE THAT ANY WHEELCHAIR TIE-DOWN SYSTEM SPECIFIED AND DEPICTED ON THIS DRAWING MEETS ALL DESTINATION STATE SPECIFICATIONS AND TO ALSO ENSURE THAT THE WHEELCHAIRS CAN BE PLACED AND REMOVED WITH RESPECT TO: SEATS, EYE'S, SIDE EMERGENCY DOORS, HEATERS, LIFTS, WHEELHOUSES, ETC.
 POSSESSION OF THIS PRINT DOES NOT IN ANY WAY OBLIGATE IC CORP. TO BUILD THE UNIT SHOWN. WC TRACK SHOWN IS FOR REFERENCE ONLY.

THIS UNIT CONFORMS TO APPLICABLE FMVSS

THIS DOCUMENT IS IN ACCORDANCE WITH ASME B14.5M-1994 AS AMENDED BY THE INTERNATIONAL TRUCK DIVISION DIMENSIONAL AND TOLERANCING AGREEMENT-2000.

50000/49000

REVISE ONLY ON LARAF SYSTEM

INTERNATIONAL TRUCK AND ENGINE CORPORATION

INTERNATIONAL CONFIDENTIAL PROPRIETARY

REFERENCE: DUJ140A000

LINEAR MEASURE: in mm APPROX. MASS (WEIGHT):

SALES SPECIFIED DIM TOLERANCES ARE: FINISH PART INTERNAL CONTROL

FINISH PART	INTERNAL CONTROL
ONE PLACE (.1X)	+1.5 +.09
TWO PLACE (.001)	+0.8 +.03
THREE PLACE (.0001)	+0.25 +.010
ANGLES	M

NAME: BODY PLAN PB11000 CONTROL: IE 50

DATE: 23 FEB 23 APPROVED: [Signature]

DATE: [] DATE: []

APPROVED: [Signature] DATE: []

DATE: [] DATE: []

RELEASE NO. BLUE-194

DATE: [] DATE: []

BODY PLAN

WHEELBASE 276"

PB11000, 33 FT. 5 IN., CAP 30

AT A GLANCE

Engine - Cummins
 Fuel Type - Diesel
 HP - 220 or 250
 Trans - 2500 PTS or 3000 PTS
 Size - 33'5"
 Capacity - 30
 Wheelbase - 276
 Item # - IC-04, IC-05, IC-06,
 IC-07

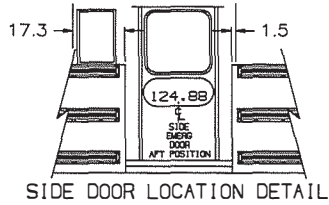
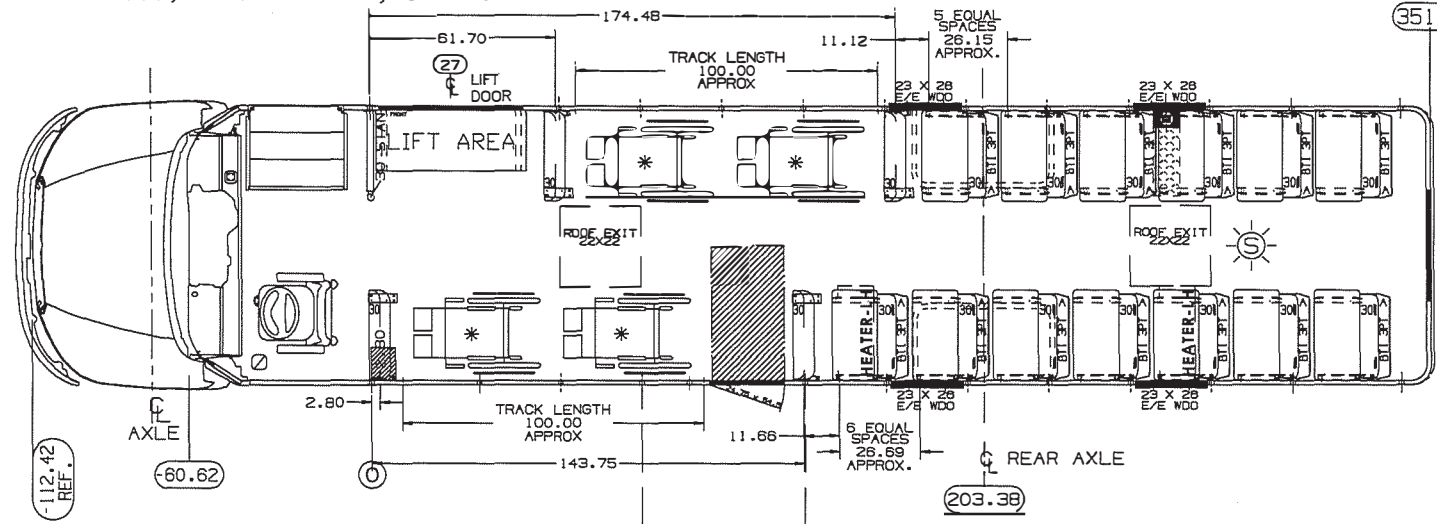

* 200" : TOTAL TRACK LENGTH (APPROXIMATELY)

• NOTE:
 IT IS THE SELLING DEALER'S RESPONSIBILITY TO ENSURE THAT ANY WHEELCHAIR TIE - DOWN SYSTEM SPECIFIED AND DEPICTED ON THIS DRAWING MEETS ALL DESTINATION STATE SPECIFICATIONS AND TO ALSO ENSURE THAT THE WHEELCHAIRS CAN BE PLACED AND REMOVED WITH RESPECT TO: SEATS, K/D'S, SIDE EMERG DOORS, HEATERS, LIFTS, WHEELHOUSES, ETC.
 POSSESSION OF THIS PRINT DOES NOT IN ANY WAY OBLIGATE IC CORP. TO BUILD THE UNIT SHOWN. WC TRACK SHOWN IS FOR REFERENCE ONLY.

THIS UNIT CONFORMS TO APPLICABLE FMVSS THIS DOCUMENT IS IN ACCORDANCE WITH ASME Y14.5M-1994 AS AMENDED BY THE INTERNATIONAL TRUCK DIVISION DIMENSIONING AND TOLERANCING (ASME) 2000.

5000/49000 REVISE ONLY ON LARAMIE SYSTEM			INTERNATIONAL TRUCK AND ENGINE CORPORATION	
	INTERNATIONAL*CONFIDENTIAL PROPRIETARY			
	REFERENCE	DJ0238A001		
	LINEAR MEASURE	<input type="checkbox"/> mm	<input checked="" type="checkbox"/> in	APPROX. MASS (WEIGHT)
	TOLERANCE SPECIFIED ON THIS DRAWING ARE:	ROUGH PART FINISH PART		
	ONE PLACE (1.30)	+1.5	+0.08	ROAD ANGLE PROJECTION INTERNAL CONTROL
	TWO PLACE (1.300)	+0.5	+0.03	
	THREE PLACE (1.3000)	+0.25	+0.010	
	ANGLES	+1		
	NAME	BODY PLAN PB11000		
DATE	29FEB23			
APPROVED	DATE	APPROVED	DATE	
DATE	PTR NO. CODE	PART TYPE CODE	SOLE AGENT	
REVISE NO.	PART NO.	BLUE - 195		

AT A GLANCE

Engine - Cummins
 Fuel Type - Diesel
 HP- 220
 Trans - 2500 PTS
 Size 19' 11"
 Capacity - 34
 Wheelbase - 170
 Item # - IC-08

BODY PLAN
 WHEELBASE 170"
 PB11000, 19 FT. 11 IN., CAP 34

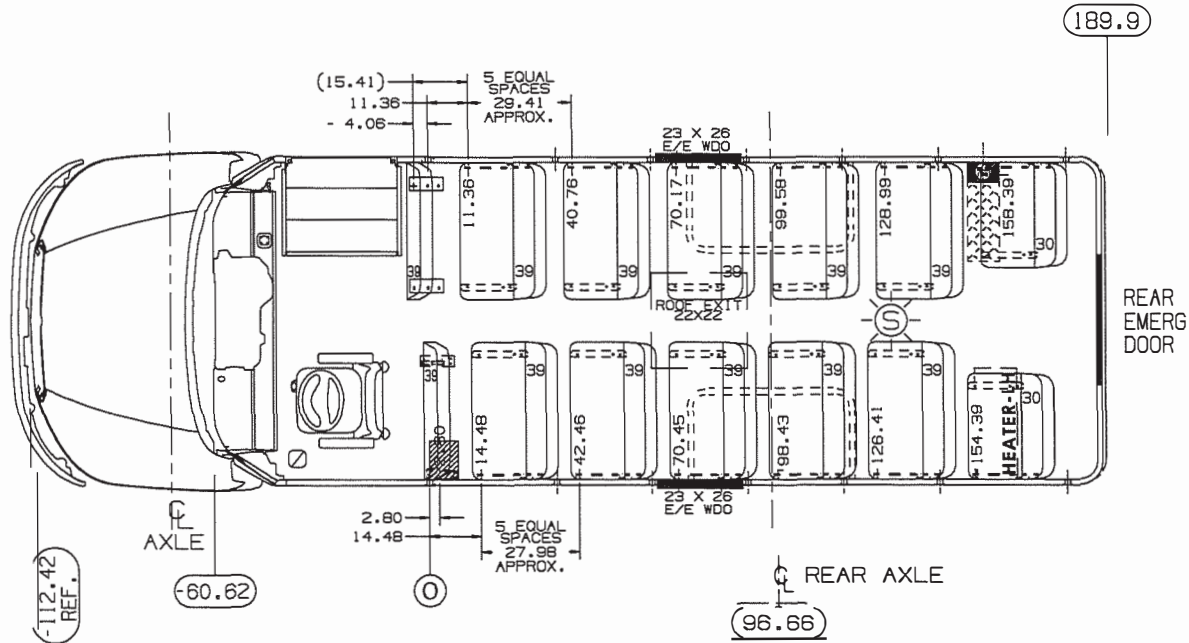

50000/49000

INTERNATIONAL TRUCK AND ENGINE CORPORATION
 INTERNATIONAL CONFIDENTIAL PROPRIETARY

REVISIONS		APPROX. MASS (WEIGHT)	
LINEAR MEASUREMENT		ROUGH PART	
ONE PLACE (1.0)		THIRD PLACE (0.001)	
TWO PLACE (0.01)		FOURTH PLACE (0.0001)	
THREE PLACE (0.001)		FIFTH PLACE (0.00001)	
DATE		DATE	
DRAWN		CHECKED	
DATE		DATE	
APPROVED		DATE	
DATE		DATE	
RELIEVE NO.		RELIEVE NO.	

NAME: BODY PLAN PB11000
 SCALE: NONE
 SIZE: 4
 CONTROL: E 50
 PROPERTY: IC
 DATE: 120CT23
 MATERIAL: U02A557
 FINISH PART: HEATER
 INTERNAL CONTROL:

BLUE - 214

THIS UNIT CONFORMS TO APPLICABLE FMVSS
THIS DOCUMENT IS IN ACCORDANCE WITH ASME Y14.5M-1993 AS AMENDED BY THE INTERNATIONAL TRUCK DIVISION DIMENSIONING AND TOLERANCING ADDENDUM-2000.

BODY PLAN

WHEELBASE 218"

PB11000, 26 FT. 8 IN., CAP 52

AT A GLANCE

Engine - Cummins
 Fuel Type- Diesel
 HP 220 or 250
 Trans - 2500 PTS
 Size 26'8"
 Capacity -52
 Wheelbase- 218
 Item # IC-09 or IC-10

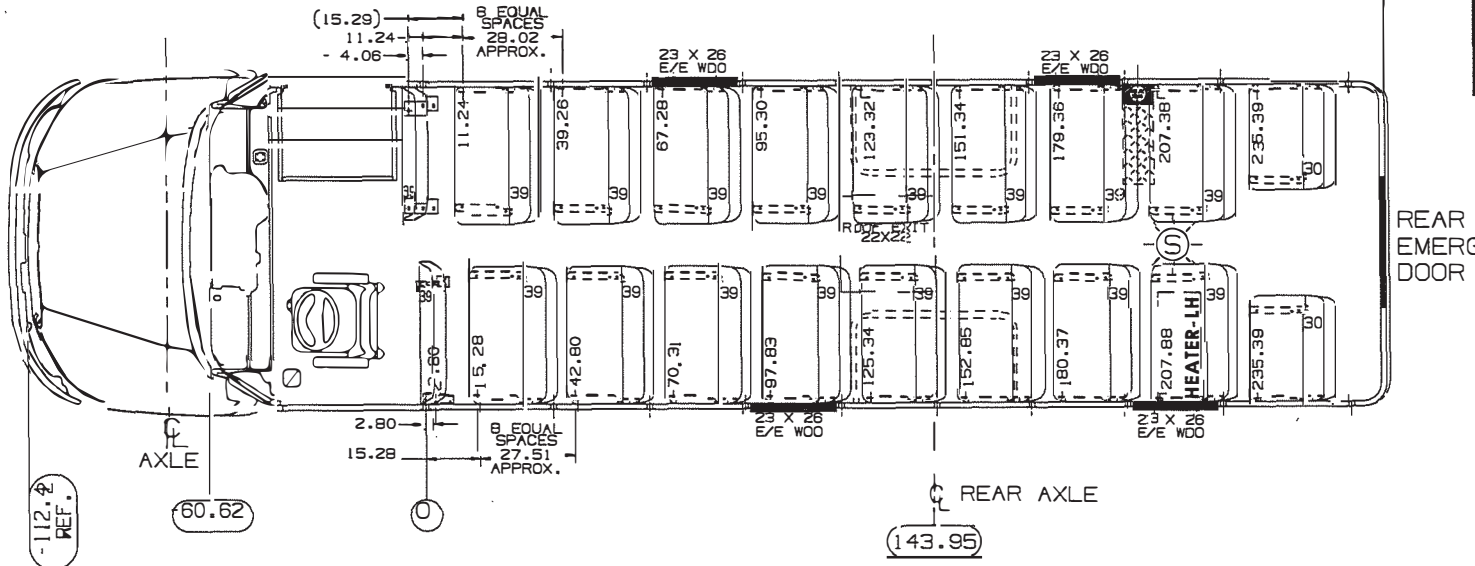

50ZBM/49001

		INTERNATIONAL TRUCK AND ENGINE CORPORATION	
		INTERNATIONAL CONFIDENTIAL PROPRIETARY	
REFERENCE	DX0166A001		
L/N LINEAR MEASURE	1/8"	1/4"	APPROX. MASS (WEIGHT)
UNLESS SPECIFIED BY TOLERANCES ARE	FINISH PART		
ONE PLACE (1.00)	±0.00	±0.08	INTERNAL CONTROL
TWO PLACE (1.00)	±0.00	±0.03	
THREE PLACE (1.00)	±0.00	±0.01	
ANGLES	°		
NAME	BODY PLAN PB11000		CONTROL
DATE			VERSION
			E 50
			E
DATE	APPROVED	DATE	
DATE			
APPROVED	PART NAME CODE	PART TYPE CODE	SOLE
DATE			SIZE
RELEASE NO.	DM0047A001		4
			01
			TYPE

THIS UNIT CONFORMS TO APPLICABLE FMVSS THIS DOCUMENT IS IN ACCORDANCE WITH ASME Y14.5M-1994 AS AMENDED BY THE INTERNATIONAL TRADE DIVISION DIMENSIONING AND TOLERANCING STANDARDS-2000.

BODY PLAN

WHEELBASE 276"

PB11000, 32 FT. 8 IN., PLUS 9 RR., CAP 66

AT A GLANCE

Engine - Cummins
 Fuel Type - Diesel
 HP - 220 or 250
 Trans- 2500 PTS or 3000PTS
 Size 32' 8"
 Capacity - 66
 Wheelbase 276
 Item # IC-11, IC-12, IC-15,
 IC-16

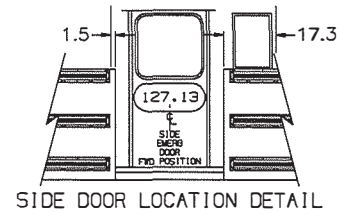
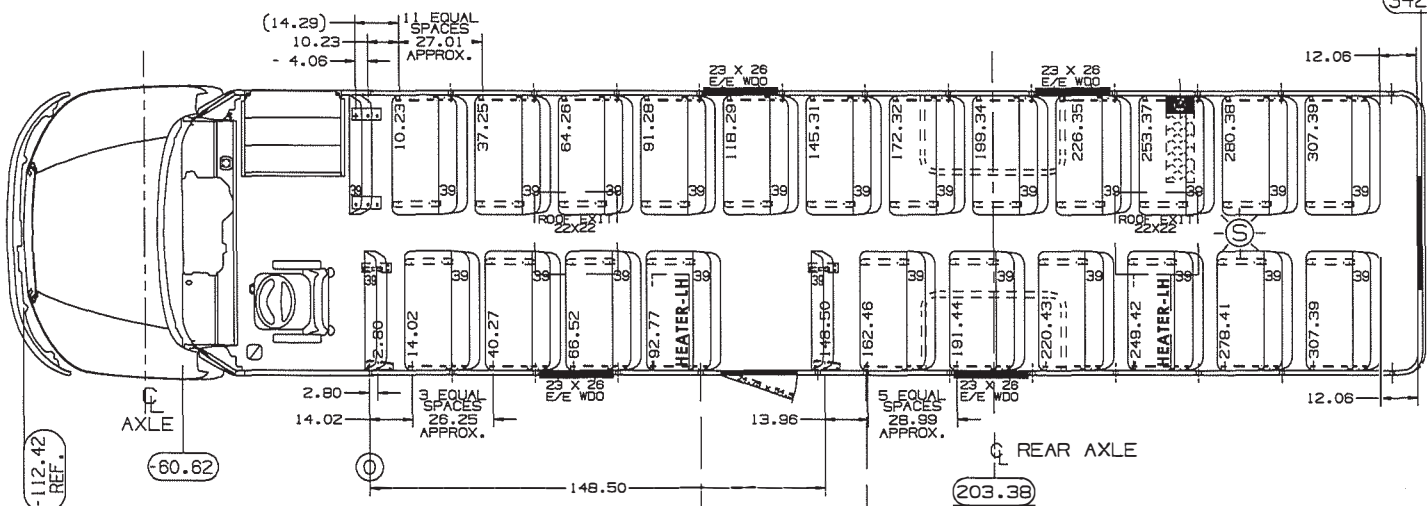

THIS UNIT CONFORMS TO APPLICABLE FMVSS THIS DOCUMENT IS IN ACCORDANCE WITH ASME Y14.5M-1993 AS AMENDED BY THE INTERNATIONAL TRUCK DIVISION DIMENSIONS AND TOLERANCES ADDENDUM-2000.

50000/49000

INTERNATIONAL TRUCK AND ENGINE CORPORATION
INTERNATIONAL*CONFIDENTIAL PROPRIETARY

REFERENCE: DX0026A000/DMD111A000		APPROX. MASS (WEIGHT)	
LINEAR MEASURE: <input type="checkbox"/> IN <input checked="" type="checkbox"/> MM		ROUGH PART	
UNLESS OTHERWISE SPECIFIED DIM TOLERANCES ARE:		FINISH PART	
ONE PLACE (+.X)	MM	IN	THIRD ANGLE PROJECTION
TWO PLACE (+.XX)	MM	IN	INTERNAL CONTROL
THREE PLACE (+.XXX)	MM	IN	
ANGLES	°		
NAME	BODY PLAN PB11000		CONTROL
DATE			E 50
APPROVED	PART NAME CODE	PART TYPE CODE	SCALE
DATE			NONE
ISSUE	PART NO.		SHEET
RELEASE NO.	BLUE - 193		01

BODY PLAN

WHEELBASE 276"

PB11000, 34 FT. 2 IN., CAP 72

AT A GLANCE

Engine - Cummins
 Fuel Type Diesel
 HP - 220 or 250
 Trans- 2500 PTS or 3000PTS Size 34 2"
 Capacity - 72
 Wheelbase 276
 Item # IC-13, IC-14, IC-17, IC-18

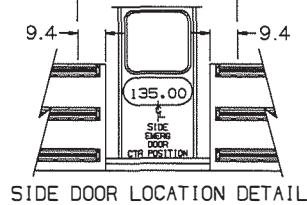
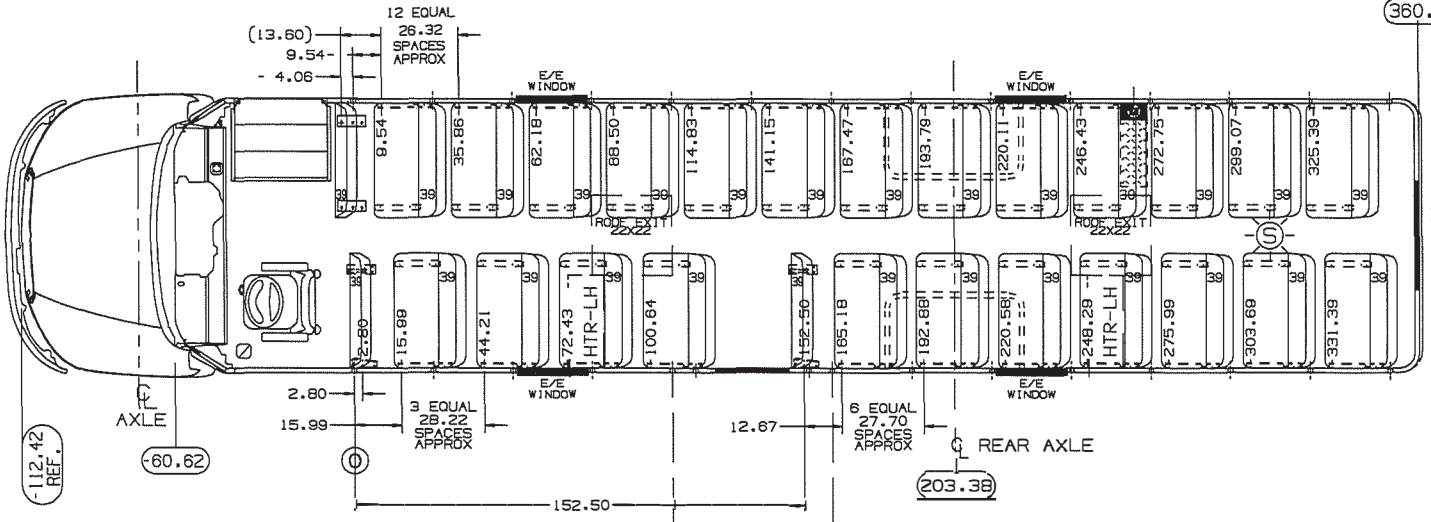

50000/49000			INTERNATIONAL TRUCK AND ENGINE CORPORATION		INTERNATIONAL CONFIDENTIAL PROPRIETARY	
	REFERENCE: DM0110A000		APPROX. MASS (WEIGHT)		INTERNAL CONTROL	
	LINEAR MEASURE: <input type="checkbox"/> in <input checked="" type="checkbox"/> mm		ROUGH PART		FINISH PART	
	UNLESS SPECIFIED DIM TOLERANCES ARE:		TYP (IN)		TYP (MM)	
	ONE PLACE (1:X)		+1.0 -0.0		+0.4 -0.0	
	TWO PLACE (1:10)		+0.10 -0.03		+0.25 -0.10	
	THREE PLACE (1:100)		+0.25 -0.10		+0.10 -0.05	
	FOUR PLACE (1:1000)		+0.25 -0.10		+0.10 -0.05	
	ANGLES		M1		M1	
	NAME: BODY PLAN PB11000		CONTROL: E 50		REVISION: E	
DATE: 24OCT22		APPROVED: _____		DATE: _____		
DRAWN: U02A559		PART NO.:		SIZE: 4		
DATE: _____		PART TYPE CODE:		SCALE: NONE		
APPROVED: _____		PART NO.:		SIZE: 4		
DATE: _____		PART TYPE CODE:		SCALE: NONE		
RELEASE NO.:		PART NO.:		SIZE: 4		
DATE: _____		PART TYPE CODE:		SCALE: NONE		
RELEASE NO.:		PART NO.:		SIZE: 4		
DATE: _____		PART TYPE CODE:		SCALE: NONE		

THIS UNIT CONFORMS TO APPLICABLE FMVSS THIS DOCUMENT IS IN ACCORDANCE WITH ASME Y14.5M-1994 AS AMENDED BY THE INTERNATIONAL TRUCK DIVISION DIMENSIONS AND TOLERANCES ADDENDUM-2000.

AT A GLANCE

Engine - Electric
 Fuel Type - Battery
 HP - 342
 Size 26' 8"
 Capacity - 52
 Wheelbase 218
 Item # IC-19

BODY PLAN

WHEELBASE 218"

PB10E00, 26 FT. 8 IN., CAP 52

TRACK LENGTH
250.00
APPROX.

270.9

8 EQUAL SPACES
28.00
APPROX.

23 X 26
E/E WDO

23 X 26
E/E WDO

REAR
EMERG
DOOR

AXLE

23 X 26
E/E WDO

23 X 26
E/E WDO

REAR AXLE

-110.37
REF.

47.54

143.95

 500" = TOTAL TRACK
 LENGTH (APPROXIMATELY)

50000/49000



INTERNATIONAL TRUCK AND ENGINE
CORPORATION

INTERNATIONAL CONFIDENTIAL PROPRIETARY

REFERENCE		000	
LINEAR MEASURE: <input type="checkbox"/> MM <input checked="" type="checkbox"/> IN		APPROX. MASS (WEIGHT)	
UNLESS SPECIFIED DIM TOLERANCES ARE:		FINISH PART	
		FINISH PART	
ONE PLACE (.130)	+1.5	+0.08	 INTERNAL CONTROLS
TWO PLACE (.001)	+0.8	+0.03	
THREE PLACE (.0001)	+0.25	+0.010	
NAME		CONTROL	
BODY PLAN PB10E00		E 50	
DATE		REVISION	
17OCT23		RE	
DATE		APPROVAL	
		DATE	
APPROVED:	PURCHASER CODE	PART TYPE CODE	SCALE
			NONE
DATE:	PART NO.	SHEET	
		4	
RELEASE NO.	BLUE-215		

THIS UNIT CONFORMS TO APPLICABLE FMVSS

THIS DOCUMENT IS IN ACCORDANCE WITH ASME Y14.5M-1994
AS AMENDED BY THE INTERNATIONAL TRUCK DIVISION
DIMENSIONING AND TOLERANCING APPENDIX-2000.

BODY PLAN

WHEELBASE 276"

PB10E00, 34 FT. 2 IN., CAP 72

AT A GLANCE

Engine - Electric
 Fuel Type - Battery
 HP - 342
 Size 34 2"
 Capacity - 72
 Wheelbase 276
 Item # IC-20

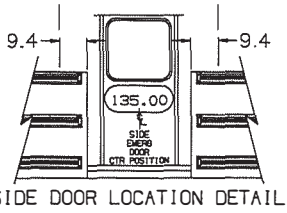
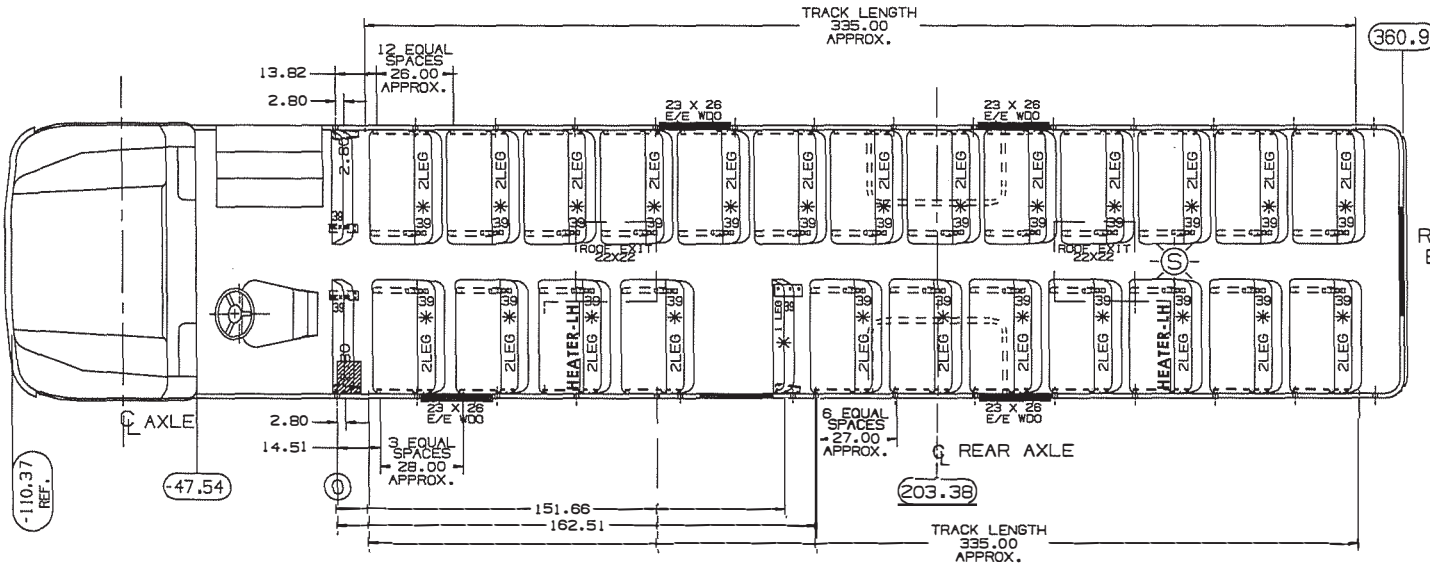

* 670" : TOTAL TRACK LENGTH (APPROXIMATELY)

THIS UNIT CONFORMS TO APPLICABLE FMVSS

THIS DOCUMENT IS IN ACCORDANCE WITH ASME Y14.5M-1994 AS AMENDED BY THE INTERNATIONAL TRUCK DIVISION DIMENSIONING AND TOLERANCING ADDENDUM-2000.

50000/49000	INTERNATIONAL TRUCK AND ENGINE CORPORATION INTERNATIONAL CONFIDENTIAL PROPRIETARY			
	REFERENCE	000	APPROX. MASS (WEIGHT)	
	LINEAR MEASURE 1	<input type="checkbox"/> mm <input checked="" type="checkbox"/> in	ROUGH PART	
	TOLERANCES UNLESS OTHERWISE SPECIFIED	mm	FINISH PART	
	ONE PLACE (1.0)	+1.0 -0.0	TRUCK PRICE PROJECTION	INTERNAL CONTROL
	TWO PLACE (1.00)	+0.15 -0.03	THIRD ANGLE PROJECTION	
	THREE PLACE (1.000)	+0.25 -0.010		
	ANGLES	+/-		
	NAME	BODY PLAN PB10E00		SCALE
	REVISION			VERSION
DATE			DATE	
APPROVED	DESIGNER	DATE	DATE	
DATE	PART NO.	PART TYPE DESC.	SOLE SOURCE	
RELEASE NO.	BLUE-205		REV. 4	
			01	



Kentucky Department of Education
2024 Thomas Built Buses School Bus Purchase Authorization

The _____ Board of Education, located in _____ Kentucky, on the ____ day of _____, 20____, in a legally called and constituted meeting, voted to purchase school buses through the Commonwealth of Kentucky contract price procedure.

This Board of Education took this official action to authorize the Chief State School Officer to procure 2024 school buses. This action, as spread upon the minutes of the meeting of this Board of Education on the above date, should be construed as evidence of obligation of this Board of Education to purchase the above school buses through the Commonwealth of Kentucky contract agreements established in accordance with statutory authority.

Signed
_____, Secretary
_____, Superintendent
of the _____ Board of Education
On the ____ day of _____, 20_____.

BODY SIDE NUMBERS: Indicate the body side number the Board of Education wants painted on the side of the body of each school bus. Match body side number to individual item numbers. Example: Item 1 - Side number - 5, 6, 7, 8

Due to supply chain issues, the current lead time for school bus completion is 240 days from the receipt of the order.
Attach additional information if necessary.



**Thomas Built Buses
School Bus Options**

Special Needs Diesel School Buses

Item #	Quantity	Bus Type	Capacity	Engine	Chassis	HP	Transmission	Wheel Base	Rear Axle Overhang	Base Purchase Price
TH1		C	16	CUMMINS	FREIGHTLINER	200	ALLISON 2500 PTS	159	99	\$127,269
TH2		C	21	CUMMINS	FREIGHTLINER	200	ALLISON 2500 PTS	219	129	\$128,114
TH3		C	20	CUMMINS	FREIGHTLINER	200	ALLISON 2500 PTS	219	129	\$133,095
TH4		C	24	CUMMINS	FREIGHTLINER	220	ALLISON 2500 PTS	279	159	\$141,229
TH5		C	34	CUMMINS	FREIGHTLINER	220	ALLISON 2500 PTS	279	159	\$142,375

Special Needs Electric School Bus

Item #	Quantity	Bus Type	Capacity	Engine	Chassis	HP	Transmission	Wheel Base	Rear Axle Overhang	Base Purchase Price
TH6		C	24	PROTERRA	FREIGHTLINER	161	EATON	279	159	\$420,353

Type C – Diesel School Buses

Item #	Quantity	Bus Type	Capacity	Engine	Chassis	HP	Transmission	Wheel Base	Rear Axle Overhang	Base Purchase Price
TH7		C	34	CUMMINS	FREIGHTLINER	200	ALLISON 2500 PTS	159	99	\$115,210
TH8		C	52	CUMMINS	FREIGHTLINER	200	ALLISON 2500 PTS	219	129	\$122,717
TH9		C	66	CUMMINS	FREIGHTLINER	220	ALLISON 2500 PTS	279	149	\$131,590
TH10		C	72	CUMMINS	FREIGHTLINER	220	ALLISON 2500 PTS	279	149	\$132,062



Type C – Electric School Buses

Item #	Quantity	Bus Type	Capacity	Engine	Chassis	HP	Transmission	Wheel Base	Rear Axle Overhang	Base Purchase Price
TH11		C	66	PROTERRA	FREIGHTLINER	161	EATON	279	149	\$424,484
TH12		C	72	PROTERRA	FREIGHTLINER	161	EATON	279	149	\$425,627

Type D – Diesel School Buses

Item #	Quantity	Bus Type	Capacity	Engine	Chassis	HP	Transmission	Wheel Base	Rear Axle Overhang	Base Purchase Price
TH13		D/FC	70	CUMMINS	FREIGHTLINER	260	ALLISON 3000 PTS	212	156	\$157,235
TH14		D/FC	74	CUMMINS	FREIGHTLINER	260	ALLISON 3000 PTS	212	156	\$158,235
TH15		D/FC	78	CUMMINS	FREIGHTLINER	260	ALLISON 3000 PTS	231	155	\$158,941
TH16		D/RE	78	CUMMINS	FREIGHTLINER	240	ALLISON 3000 PTS	267	115	\$167,140
TH17		D/RE	84	CUMMINS	FREIGHTLINER	280	ALLISON 3000 PTS	267	115	\$171,887



Thomas Built Buses Optional School Bus Products

Radio Options

Item #	Bus Type	Description	Price
THO1	C & D	PAGE SYSTEM ONLY - NO RADIO	\$740.00
THO2	C	DELPHI AM / FM RADIO WITH FLUSH-MOUNTED SPEAKERS (NO PAGE)	\$770.00
THO3	C	DELPHI AM / FM RADIO WITH FLUSH-MOUNTED SPEAKERS, OUTSIDE SPEAKER W/ PAGE, CHASSIS MOUNTED	\$865.00
THO4	D	DELPHI AM / FM RADIO WITH FLUSH-MOUNTED SPEAKERS (TYPE D ER/FORWARD CONTROL 70 - 84) (NO PAGE)	\$865.00
THO5	D	DELPHI AM / FM RADIO WITH FLUSH-MOUNTED SPEAKERS, OUTSIDE SPEAKER, CHASSIS MOUNTED (TYPE D ER AND FC 70 - 84) PA	\$990.00

Camera Options

Item #	Bus Type	Description	Price
THO6	ALL	DVR-908LP1-256 - Pro-Vision Titan, 1080P High-Definition Solid State DVR, (1) Low profile 1080P HD Camera, Passive GPS, Event Marker Button, Power Harness, Playback Software, 256gb SDXC, Health Alert Dashboard, 5 Year warranty	\$1,400.00
THO7	ALL	DVR-908LP1-512 - Pro-Vision Titan, 1080P High-Definition Solid State DVR, (1) Low profile 1080P HD Camera, Passive GPS, Event Marker Button, Power Harness, Playback Software, 512gb SDXC, Health Alert Dashboard, 5 Year warranty	\$1,500.00
THO8	ALL	DVR-908LP2-256 - Pro-Vision Titan, 1080P High-Definition Solid State DVR, (1) Low profile 1080P HD Camera, Passive GPS, Event Marker Button, Power Harness, Playback Software, 256gb SDXC, Health Alert Dashboard, 5 Year warranty	\$1,625.00
THO9	ALL	DVR-908LP2-512 - Pro-Vision Titan, 1080P High-Definition Solid State DVR, (1) Low profile 1080P HD Camera, Passive GPS, Event Marker Button, Power Harness, Playback Software, 512gb SDXC, Health Alert Dashboard, 5 Year warranty	\$1,725.00
THO10	ALL	DVR-908LP3-256 - Pro-Vision Titan, 1080P High-Definition Solid State DVR, (1) Low profile 1080P HD Camera, Passive GPS, Event Marker Button, Power Harness, Playback Software, 256gb SDXC, Health Alert Dashboard, 5 Year warranty	\$1,850.00
THO11	ALL	DVR-908LP3-512 - Pro-Vision Titan, 1080P High-Definition Solid State DVR, (1) Low profile 1080P HD Camera, Passive GPS, Event Marker Button, Power Harness, Playback Software, 512gb SDXC, Health Alert Dashboard, 5 Year warranty	\$1,950.00
THO12	ALL	DVR-908LP4-256 - Pro-Vision Titan, 1080P High-Definition Solid State DVR, (1) Low profile 1080P HD Camera, Passive GPS, Event Marker Button, Power Harness, Playback Software, 256gb SDXC, Health Alert Dashboard, 5 Year warranty	\$2,075.00



Item #	Bus Type	Description	Price
THO13	ALL	DVR-908LP4-512 - Pro-Vision Titan, 1080P High-Definition Solid State DVR, (1) Low profile 1080P HD Camera, Passive GPS, Event Marker Button, Power Harness, Playback Software, 512gb SDXC, Health Alert Dashboard, 5 Year warranty	\$2,175.00
THO14	ALL	PRO-VISION DVR-912 - Pro-Vision AHD Low Profile Waterproof Camera Kit - EXTERIOR CAMERA	\$295.00
THO15	ALL	PRO- VISION DVR-920 - Pro-Vision AHD Waterproof Side Camera - Exterior Camera	\$295.00
THO16	ALL	PRO-VISION DVR-921 - Pro-Vision AHD Mini Dome Camera Kit	\$295.00
THO17	ALL	PRO-VISION DVR-922 -Pro-Vision AHD Dash Camera - (windshield mounting)	\$395.00
THO18	ALL	PRO-VISION DVR-923 -Pro-Vision AHD Ultra-Wide Low-Profile Camera	\$295.00
THO19	ALL	PRO-VISION DVR-824 - Pro-Vision 1080P High-Definition Dual Facing Stop Arm Camera	\$895.00
THO20	ALL	PRO-VISION PX-1943 - 30' Camera Cable / 10m	\$40.00
THO21	ALL	ECB-1YR -PROVISION WIRELESS TRANSFER KIT - 1 YEAR	\$100.00
THO22	ALL	ECB-3YR -PROVISION WIRELESS TRANSFER KIT - 3 YEAR	\$280.00
THO23	ALL	ECB-5YR -PROVISION WIRELESS TRANSFER KIT - 5 YEAR	\$420.00
THO24	ALL	PROVISION 256GB CARD - PD-1738	\$180.00
THO25	ALL	PROVISION 512GB CARD - PD-1748	\$320.00
THO26	ALL	PROVISION 1 TB CARD - PD-1758	\$500.00
THO27	ALL	PRO-VISION DVR-830 - 500GB Solid State Drive, Compatible with Pro-Vision System	\$450.00
THO28	ALL	PRO-VISION DVR-831 - 1 TB Solid State Drive, Compatible with Pro-Vision System	\$550.00
THO29	ALL	PRO-VISION - DVR-802 - Solid State Drive Reader	\$55.00
THO30	ALL	PRO-VISION - DR-200-1TB - 2 VIEW DRIVE RECORDER 1 TB OF STORAGE	\$895.00
THO31	ALL	PRO-VISION - PX-1210 - ANALOG CAMERA ADAPTOR	\$175.00
THO32	ALL	INSTALLATION FOR BASIC SYSTEM AT BOYD FACILITY (INCLUDES 1 CAMERA HEAD)	\$495.00
THO33	ALL	INSTALLATION FOR EACH ADDITIONAL CAMERA HEAD	\$150.00
THO34	ALL	DH4C 128 - SEON SOLID STATE DVR, 4 HD CHANNELS, AUDIO, WIFI, G SENSOR, MOUNTING PLATE, POWER HARNESS, 128GB SD CARD, NO CAMERA HEADS INCLUDED	\$950.00
THO35	ALL	DH4 - SEON DVR, 4 HD CHANNELS, AUDIO, WIFI, SECURITY FRONT LOCKING COVER, MNT PLATE, POWER HARNESS, 500GB HARD DRIVE - NO CAMERA HEADS INCLUDED	\$1,150.00
THO36	ALL	DH6- SEON DVR, 6 HD CHANNELS, AUDIO, GPS + ANTENNA, WIFI, 6 CH BREAKOUT HARNESS WITH 2X3 VIDEO CONNECTORS, SECURITY LOCKING FRONT COVER, MNT PLATE, POWER HARNESS, 500GB HARD DRIVE - NO CAMER HEADS INCLUDED	\$1,600.00
THO37	ALL	DH8 - SEON DH8 DVR, 8 HD CHANNEL, AUDIO, GPS + ANNTENA, WIFI, 8CH BREAKOUT HARNESS WITH 2X3 VIDEO CONNECTORS, SECURITY LOCKING FRONT COVER, MNT PLATE, POWER HARNESS, 1 TB HARD DRIVE - NO CAMERA HEADS INCLUDED	\$2,200.00
THO38	ALL	WT2E20S20G6 - WIRE BUNDLE W. HARNESS, RGY BUTTON AND 20 FT CABLE, 5 SIGNAL INPUTS 20 FT, GPS ANTENNA MAGNETIC MOUNT FOR DH4C OR DH4 USE THIS	\$160.00



Item #	Bus Type	Description	Price
THO39	ALL	WT2E20S20G0 - WIRE BUNDLE W. HARNESS, RGY BUTTON AND 20 FT CABLE, 5 SIGNAL INPUTS 20 FT, NO GPS ANTENNA FOR DVR DH6 OR DH8 USE THIS	\$160.00
THO40	ALL	HD1QXXAI20 - HD 720P CAMERA, DOME, pick a LENS SIZE 2.6, 3.6 OR 6.0mm, 20' harness - FOR USE WITH DH OR OLDER TH SERIES SYSTEMS	\$310.00
THO41	ALL	HD1QXXAI50 - HD 720P CAMERA, DOME, pick a LENS SIZE 2.6, 3.6 OR 6.0mm, 50' harness - FOR USE WITH DH OR OLDER TH SERIES SYSTEMS	\$325.00
THO42	ALL	HD1QXXAI75 - HD 720P CAMERA, DOME, pick a LENS SIZE 2.6, 3.6 OR 6.0mm, 75' harness - FOR USE WITH DH OR OLDER TH SERIES SYSTEMS	\$350.00
THO43	ALL	HD3U01N20 180-degree head -- WITH 20' HARNESS - for all DH systems and TH6	\$390.00
THO44	ALL	HD3U01N50 180-degree head -- WITH 50' HARNESS - for all DH systems and TH6	\$425.00
THO45	ALL	HD3U01N75 180-degree head -- WITH 75' HARNESS - for all DH systems and TH6	\$445.00
THO46	ALL	HD3S16EI20 - HD STOP ARM CAMERAS, 16mm EXTRENAL, 20' HARNESS	\$575.00
THO47	ALL	CHQ-MP6A30 - MOUNTING POST. 6", 30%	\$85.00
THO48	ALL	TH-HK500G - H SERIES 500GB HARD DRIVE - FOR DH4/DH6	\$275.00
THO49	ALL	TH8-HK1T0 - H SERIES - 1TB HARD DRIVE, DOUBLE WIDE - FOR DH8	\$400.00
THO50	ALL	HDIA20 - EVENT BUTTON, 5' WITH 20 ' EXT	\$95.00
THO51	ALL	HDD3-STB - READER DOCK WITH TRACKBALL SOFTWARE (NEW CUSTOMER ONLY)	\$395.00
THO52	ALL	HDD-DOCK3 - READER DOCK ONLY, NO SOFTWARE, NO MOUSE	\$310.00
THO53	ALL	SRLA07 - SMART REACH LITE, 2.4 GHZ, STAND ANTENNA 6' CABLE & POE ADAPTOR	\$595.00
THO54	ALL	LMK - LCD MONITOR	\$390.00
THO55	ALL	INSTALLATION FOR BASIC SYSTEM AT BOYD FACILITY (INCLUDES 1 CAMERA HEAD)	\$495.00
THO56	ALL	INSTALLATION FOR EACH ADDITIONAL CAMERA HEAD	\$150.00

Luggage Options

Please see attached chart for compatibility.

Item #	Bus Type	Description	Price
THO57	C	STORAGE BOXES (TYPE C) - 34 Passenger - 72 Passenger - 30 INCHES WIDE (LS or RS)	\$730.00
THO58	C	STORAGE BOXES (TYPE C) - 52 Passenger - 72 Passenger - 60 INCHES WIDE (LS or RS)	\$1,270.00
THO59	C	STORAGE BOXES (TYPE C) - 66 Passenger - 72 Passenger - 100 INCHES WIDE (LS or RS)	\$1,625.00
THO60	D/FC	STORAGE BOXES (TYPE D FC) 70-78 PASSENGER - 60" (LS or RS)	\$1,425.00
THO61	D/FC	STORAGE BOXES (TYPE D FC 78 PASSENGER - 100" (LS or RS)	\$1,665.00
THO62	D/RE	STORAGE BOXES (TYPE D RE) 78-84 PASSENGER - 60" (LS or RS)	\$1,425.00
THO63	D/RE	STORAGE BOXES (TYPE D RE 84 PASSENGER - 100" (LS or RS)	\$1,885.00



THO64	D/RE	STORAGE BOXES (TYPE D RE) 78-84 PASSENGER - CENTER PASS THRU - INCLUDES GAS SPRINGS	\$5,735.00
-------	------	---	------------

Air Conditioning A/C Options

Item #	Bus Type	Description	Price
THO65	C - 161 & 191 SHELL BUS ONLY	Type C AIR CONDITIONING SYSTEM, 161 & 191 SHELL SIZE, 85,000 BTU SYSTEM (C2)	\$9,600.00
THO66	C	Type C AIR CONDITIONING SYSTEM, 52-72 PASSENGER SHELL SIZE, 126,000 BTU SYSTEM (C2) - WITH DASH AIR - SKIRT CONDENSOR	\$13,400.00
THO67	C	Type C - DASH AIR ONLY (EXCEPT 34 SHELL) (EV JOULEY BUS - DASH AIR IS STANDARD)	\$2,875.00
THO68	D	A/C SYSTEM, 70-84 PASSENGER SHELL SIZE, 120,000 BTU SYSTEM.	\$13,400.00
THO69	ALL BUSES - EXCEPT 161 & 191 SHELL	FULL AIR CONDITIONING SYSTEM WITH ROOF CONDENSER INSTEAD OF SKIRT CONDENSER	\$16,000.00

Tire Options

Item #	Bus Type	Description	Price
THO70	C	14 PLY TO 16 PLY - (THOMAS BUS COMES STANDARD WITH MICHELIN TIRES)	\$600.00

Horsepower Upgrade Options

Item #	Bus Type	Description	Price
THO71	C	HP UPGRADE - 200 TO 220HP	\$650.00
THO72	C	HP UPGRADE - 220 TO 250HP	\$1,500.00
THO73	D/RE	HP UPGRADE - 240 TO 260HP	\$1,500.00
THO74	D/RE & FC	HP UPGRADE - 260 TO 280HP	\$1,650.00
THO75	C	DD5 DETROIT 240 HP ENGINE	\$2,450.00
THO76	D	DD8 DETROIT 280 HP ENGINE	\$5,900.00

Warranty Options

Item #	Bus Type	Description	Price
THO77	ALL	TOW WARRANTY - UNLIMITED	\$2,450.00



Seating Options

Item #	Bus Type	Description	Price
THO78	C	ADD 1 30" S3C LAP/SHOULDER TRACK MOUNTED SEAT TO A W/C POSITION TO LIFT BUS.	\$980.00
THO79	ALL	EXCHANGE - 30 INCH INTEGRATED CHILD SAFETY RESTRAINT SEAT IN LIEU OF STANDARD 30 INCH SEAT (ALL BODIES) Suitable for 22lb to 85lb children (restraint ready)	\$855.00
THO80	ALL	EXCHANGE - 30 INCH INTEGRATED CHILD SAFETY RESTRAINT SEAT w/ shoulder belts - IN LIEU OF STANDARD 30 INCH SEAT (ALL BODIES) Suitable for 22lb to 85lb children (shoulder belts)	\$1,050.00
THO81	ALL	EXCHANGE - 39 INCH INTEGRATED CHILD SAFETY RESTRAINT SEAT IN LIEU OF STANDARD 39 INCH SEAT (ALL BODIES) Suitable for 22lb to 85lb children (RESTRAINT READY)	\$855.00
THO82	ALL	EXCHANGE - 39 INCH INTEGRATED CHILD SAFETY RESTRAINT SEAT IN LIEU OF STANDARD 39 INCH SEAT (ALL BODIES) Suitable for 22lb to 85lb children (WITH SHOULDER BELTS)	\$1,050.00
THO83	C	ADD ONE ADDITIONAL W/C POSITION - ADD 1 FF630-4C TO LIFT BUS.	\$1,325.00

Miscellaneous Options

Item #	Bus Type	Option Type	Description	Price
THO84	C	NOISE ABATEMENT	ACOUSTIC NOISE ABATEMENT - FULL BODY LENGTH - 34 PASS	\$475.00
THO85	C	NOISE ABATEMENT	ACOUSTIC NOISE ABATEMENT - FULL BODY LENGTH - 52 PASS	\$670.00
THO86	C	NOISE ABATEMENT	ACOUSTIC NOISE ABATEMENT - FULL BODY LENGTH - 66-72 PASS	\$850.00
THO87	D	NOISE ABATEMENT	ACOUSTIC NOISE ABATEMENT - FULL BODY LENGTH - TYPE D	\$1,050.00
THO88	ALL	BRAKES	ADJUSTABLE PEDALS - C2 / D	\$2,080.00
THO89	ALL	BRAKES	AIR DISC BRAKES - ALL BUSES	\$1,750.00
THO90	C	BRAKES	BENDIX INTELLIPARK - PARKING BRAKE SYSTEM	\$900.00
THO91	C	FLOOR	ONE PIECE FLOOR - 161 OR 191 SHELL BUS (C2 ONLY)	\$1,000.00
THO92	C	FLOOR	ONE PIECE FLOOR - 20 OR 52 PASS SHELL BUS (C2 ONLY)	\$1,200.00
THO93	C	FLOOR	ONE PIECE FLOOR - 66 OR 72 PASS SHELL BUS (C2 ONLY)	\$1,500.00
THO94	D	HEADLIGHTS	LED HEADLIGHTS (TYPE D BUS)	\$1,150.00
THO95	ALL	LIGHTS	REFLECTIVE FIRST LIGHT FULLY ILLUMINATED ID / DESTINATION SIGNS - FRONT AND REAR - (MUST BE APPROVED PILOT ONLY - MAX OF 10 TOTAL FOR YEAR & LIMIT OF 2 PER SCHOOL DISTRICT)	\$0.00
THO96	C	TINT	TINTED WINDOWS - 161 & 191 (NON-LIFT)	\$600.00
THO97	C	TINT	TINTED WINDOWS - 52 PASS (NON-LIFT)	\$860.00
THO98	C	TINT	TINTED WINDOWS - 66-72 PASS (NON-LIFT)	\$1,000.00
THO99	D	TINT	TINTED WINDOWS - ALL TYPE D	\$1,250.00
THO100	C	TOUGH COAT	FLEETSHIELD TOUGHTCOAT CORRISION PROTECTION PROVIDES HIGH PERFORMANCE COATING ON FRONT BUMPNER	\$600.00
THO101	ALL	TRASH CAN	TRASH CAN (NO LID)	\$50.00



Item #	Bus Type	Option Type	Description	Price
THO102	C	UNDERGUARD	UNDERGUARD - 161 & 191 SHELL - CORROSION PROTECTION - HIGH PERFORMANCE UNDERCOATING APPLIED TO UNDERSIDE OF BODY	\$700.00
THO103	C	UNDERGUARD	UNDERGUARD - 52-72 PASS SHELL - CORROSION PROTECTION - HIGH PERFORMANCE UNDERCOATING APPLIED TO UNDERSIDE OF BODY	\$825.00
THO104	D	UNDERGUARD	UNDERGUARD - TYPE D - CORROSION PROTECTION - HIGH PERFORMANCE UNDERCOATING APPLIED TO UNDERSIDE OF BODY	\$950.00
THO105	C	UNDERGUARD	CORROSION EDGECOVER	\$200.00
THO106	C	HEATER	WEBASTO HEATER AND 7 DAY TIMER FOR C2 BUSES	\$1,875.00
THO107	D	HEATER	WEBASTO HEATER AND 7 DAY TIMER FOR TYPE D BUSES	\$2,270.00
THO108	C - EV JOLEY ONLY	CHARGE PORT	REMOVE FRONT RS CHARGE PORT AND ADD REAR RS CHARGE PORT ON EV JOULEY BUS	\$2,500.00
THO109	C	FUEL TANK	FUEL TANK UPGRADE - 35 TO 60 GALLON TANK - 161 & 191 SIZE BUS	\$675.00
THO110	C	FUEL TANK	FUEL TANK UPGRADE - 60 TO 100 GALLON TANK - 52 TO 72 PASS (C2)	\$875.00
THO111	ALL	ZONAR	ADD ZONAR BOX AND WIRING TO BUS	\$500.00
THO112	C	COLLISION	Meritor - Wabco ONGuard Active Collision Avoidance System allows collision warning, active braking and adaptive cruise control at forward speeds 15 MPH and above. The system provides audible, haptic and visual warnings to alert drivers to possible traffic obstructions. Radar technology provides the ability to detect potential collision conditions up to 650 feet forward of the vehicle. Avoidance system allows intervention including active braking and throttle reduction to reduce chance of impending collisions. Adaptive cruise control feature utilizes radar to assist with safe following distances from other vehicles. The system maintains set speed when lane is clear and automatically adjusts vehicle speed to maintain a set time interval between the system vehicle and vehicles ahead.	\$2,500.00
THO113	ALL	CAMERA	BACKUP CAMERA - INTERIOR MIRROR	\$1,325.00
THO114	C	CAMERA	BUS WISE - PERIMETER VIEW 360 CAMERA - C2 BUSES	\$2,995.00
THO115	D	CAMERA	BUS WISE - PERIMETER VIEW 360 CAMERA - EFX & HDX BUSES	\$2,995.00
THO116	ALL	WIFI	BUS WISE WIFI ROUTER - Wireless networking hardware. Expands capacity of customer supplied wireless hotspot	\$465.00
			This item has been intentionally removed.	
THO118	C	TRANSMISSION UPGRADE	UPGRADE TO 3000 PTS TRANSMISSION - C2 (66 & 72 SHELL ONLY)	\$3,950.00
THO119	ALL	SOFTWARE	CUMMINS INSITE LITE SOFTWARE - RECURRING ANNUAL FEE	\$720.00
THO120	ALL	SOFTWARE	CUMMINS INSITE PRO SOFTWARE - RECURRING ANNUAL FEE	\$770.00



Item #	Bus Type	Option Type	Description	Price
THO121	ALL	SOFTWARE	CUMMINS QUICKSERVE FLEET SOFTWARE - RECURRING ANNUAL FEE	\$750.00
THO122	ALL	SOFTWARE	DIAGNOSTIC LINK 8 - DETRIOT - RECURRING ANNUAL FEE	\$500.00
THO123	ALL	SOFTWARE	CAT ET - RECURRING ANNUAL FEE	\$650.00
THO124	ALL	SOFTWARE	ALLISON DOC SOFTWARE - RECURRING ANNUAL FEE	\$360.00
THO125	ALL	SOFTWARE	MERITIOT / WABCO ABS SOFTWARE - RECURRING ANNUAL FEE	\$300.00
THO126	ALL	SOFTWARE	PSI PROPANE SOFTWARE - RECURRING ANNUAL FEE	\$1,300.00



Boyd CAT Contact Information

Name	Title	Telephone Number	Email Address
Barry Zink	General Manager	(502)-774-4441 Ext. 71532	BarryZink@BoydCAT.com
Mark Pinczewski	Sales Representative	(859)-576-2201	MarkPinczewski@BoydCAT.com
Mark Thompson	Sales Representative	(615)-686-9941	MarkThompson@BoydCAT.com
Nick Couch	Sales Representative	(606)-304-3103	NickCouch@BoydCat.com

SEATING CAPACITY: 70 + DRIVER

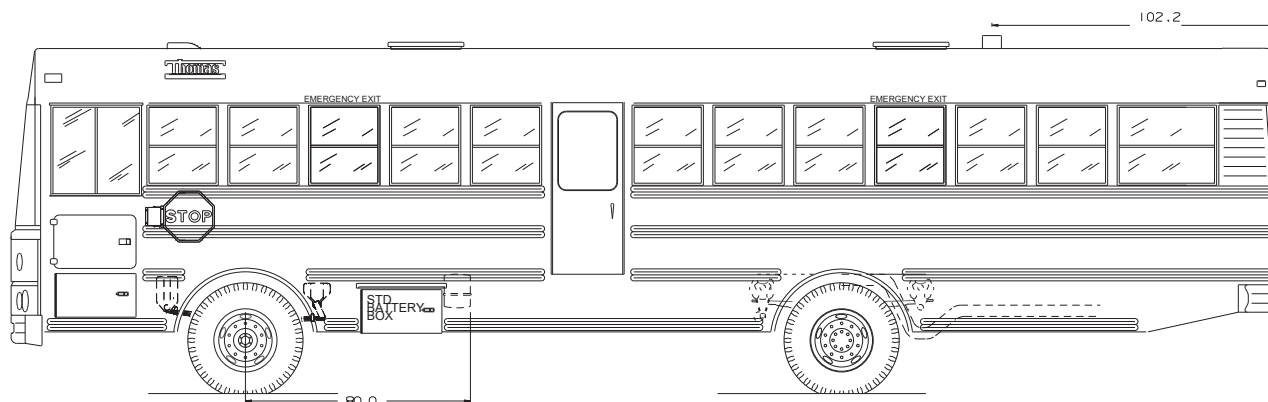

EQUIPPED WITH 23K SUSPENSION

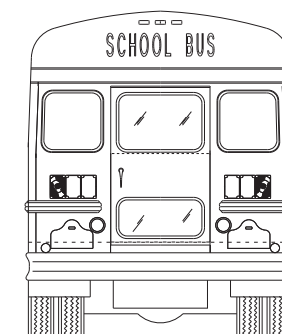

CAUTION - LEFT SIDE BARRIER IS NOT IN STANDARD LOCATION, SEE SEATING PLAN.
CAUTION! - RIGHT SIDE BARRIER IS NOT IN STANDARD LOCATION, SEE SEATING PLAN.

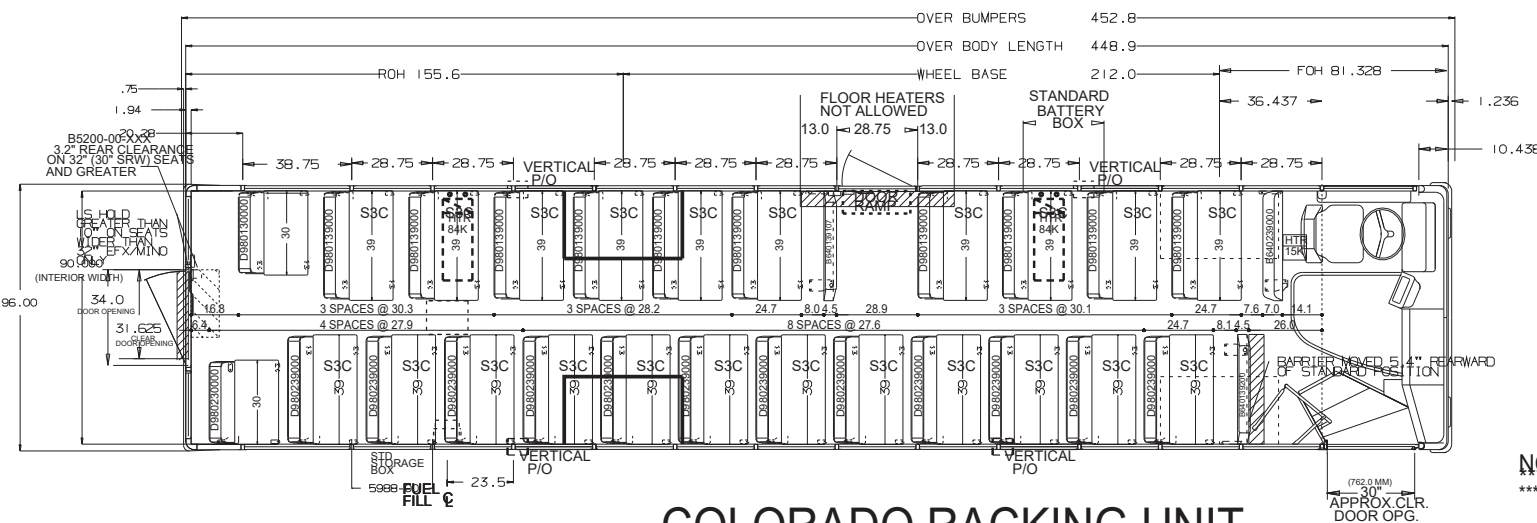

COLORADO RACKING UNIT

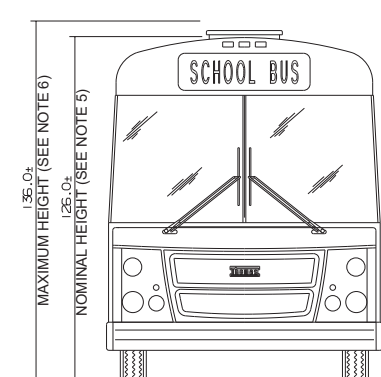

NOTES:
EFX UNIT
23K REAR SUSPENSION

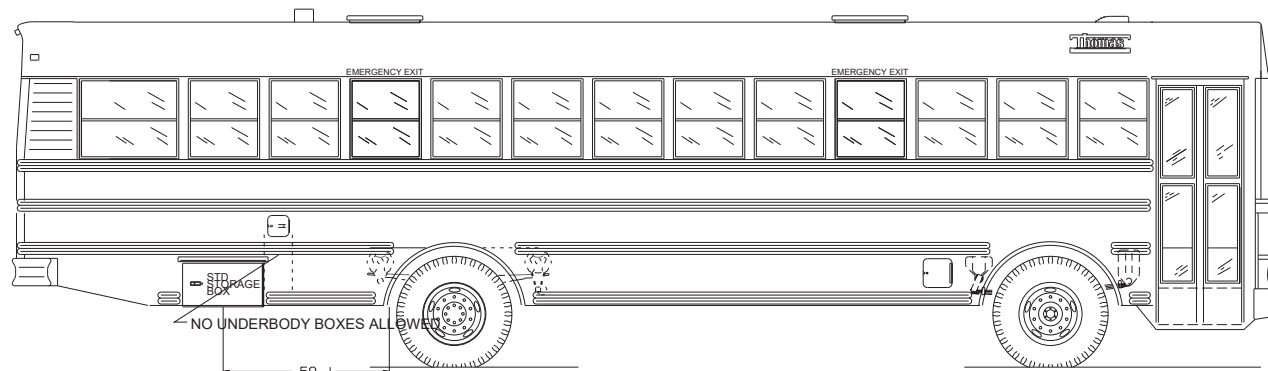

ALL DIMENSIONS ARE FOR REFERENCE ONLY

GENERAL NOTES

- SOME ITEMS, SUCH AS CV MIRRORS, ROOF LUGGAGE RACKS, AND OTHER ITEMS, ARE SHOWN IN ONE VIEW ONLY FOR CLARITY.
- THIS DRAWING IS A REPRESENTATION ONLY AND MAY NOT HAVE ALL ITEMS REQUIRED. PLEASE REFER TO ORDER!
- THE CLEARANCE BETWEEN BOTTOM OF BUS OR BOTTOM OF UNDERBODY COMPARTMENTS AND GROUND WILL VARY ACCORDING TO THE SIZE, BUS LOAD, AND SUSPENSION TYPE.
- THE MAXIMUM WIDTH AT BELT LINE OVER GUARD RAILS IS 36".
- THE MAXIMUM BUS HEIGHT IS BASED ON A STANDARD BODY AND LARGEST SIZE TIRE.
- THE MAXIMUM BUS HEIGHT IS BASED ON BODY WITH OPTIONS SUCH AS A/C UNITS, STROBE LIGHT, LARGEST SUSPENSION ETC.
- OVER BUMPER DIMENSION DOES NOT TAKE INTO ACCOUNT OPTIONS THAT MAY ADD TO THE TOTAL LENGTH OF THE BUS, SUCH AS MIRRORS, LIGHTS, AND CROSSING ARMS.

Model: MVP-EF
Quote Number: 388037
Locality: KY

THIS DRAWING AND ALL INFORMATION PROVIDED WITH IT ARE THE PROPERTY OF THOMAS BUILT BUSES, INC. ANY REPRODUCTION OR DISTRIBUTION OF THIS MATERIAL OR ANY PART WITHOUT WRITTEN PERMISSION OF THOMAS BUILT BUSES, INC. IS STRICTLY PROHIBITED. COPYRIGHT THOMAS BUILT BUSES, INC.

SIDE	ROW	SPACING	WHEEL BASE
LEFT		30.1	28.8
LEFT		28.2	26.9
LEFT		30.3	29.0
RIGHT		27.6	26.3
RIGHT		27.9	26.6

THOMAS BUILT BUSES, INC.
HIGH POINT, NC

TITLE: **PLAN AND ELEVATION BODY 1318S**

DRN: 05-24-22 BY: T. Dean
SCALE: 3/8"=12" SIZE: S DWG. NO.: 859381

SEATING CAPACITY: 74 + DRIVER

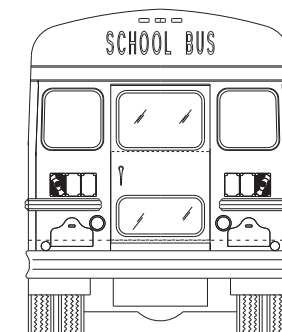
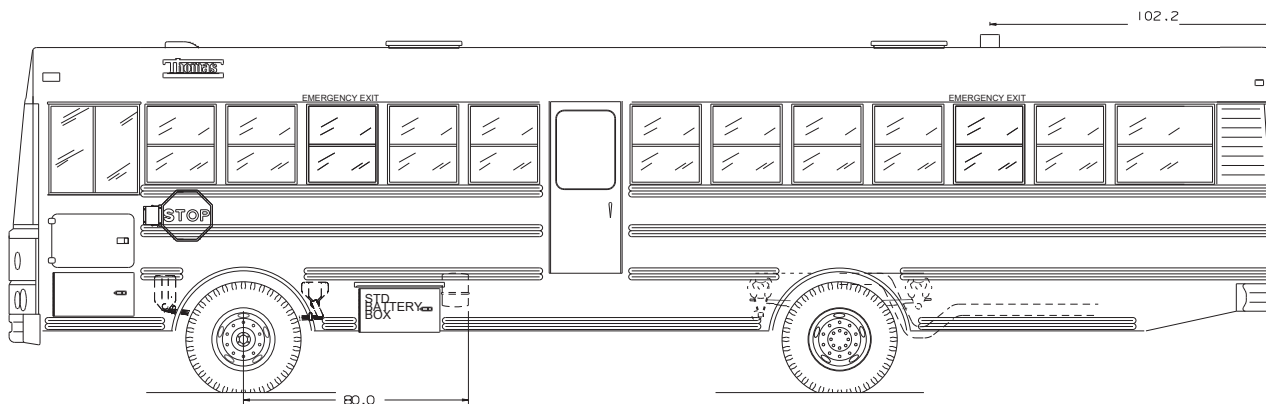

CAUTION - LEFT SIDE BARRIER IS NOT IN STANDARD LOCATION, SEE SEATING PLAN.
 CAUTION! - RIGHT SIDE BARRIER IS NOT IN STANDARD LOCATION, SEE SEATING PLAN.

EQUIPPED WITH 23K SUSPENSION

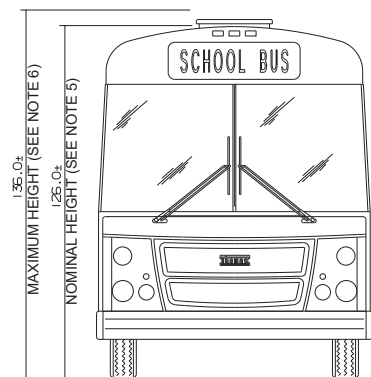
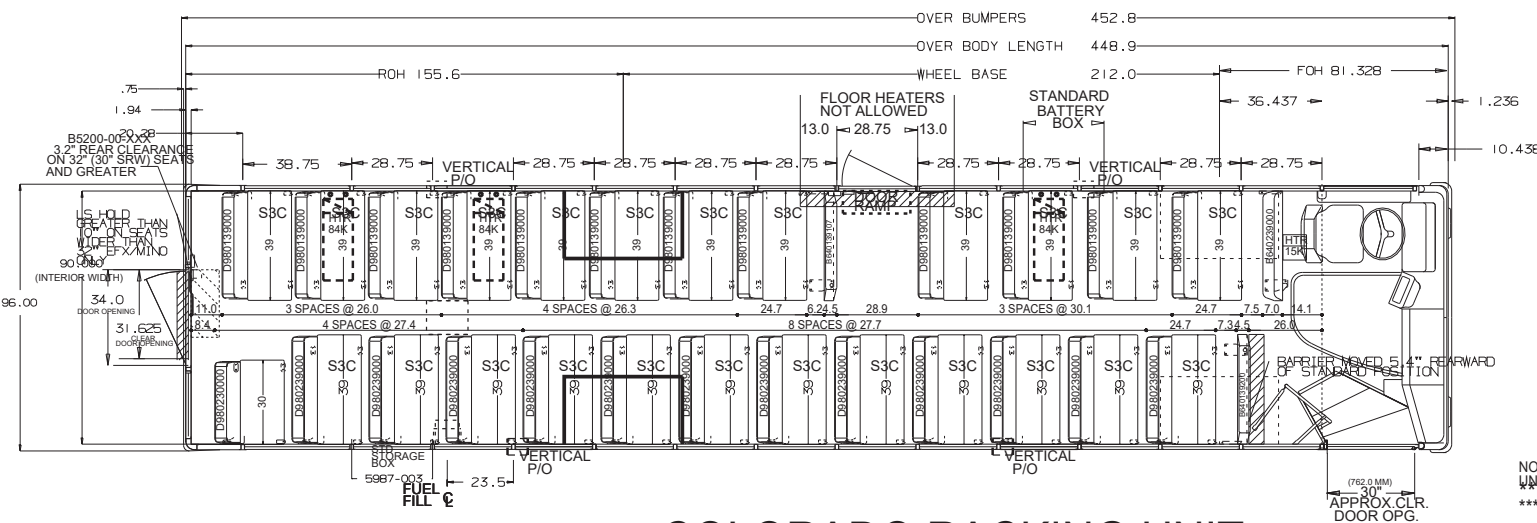

NOTES:
 **EQUIPPED WITH HLYWOOD FLOOR
 EXACT
 23K REAR SUSPENSION

COLORADO RACKING UNIT

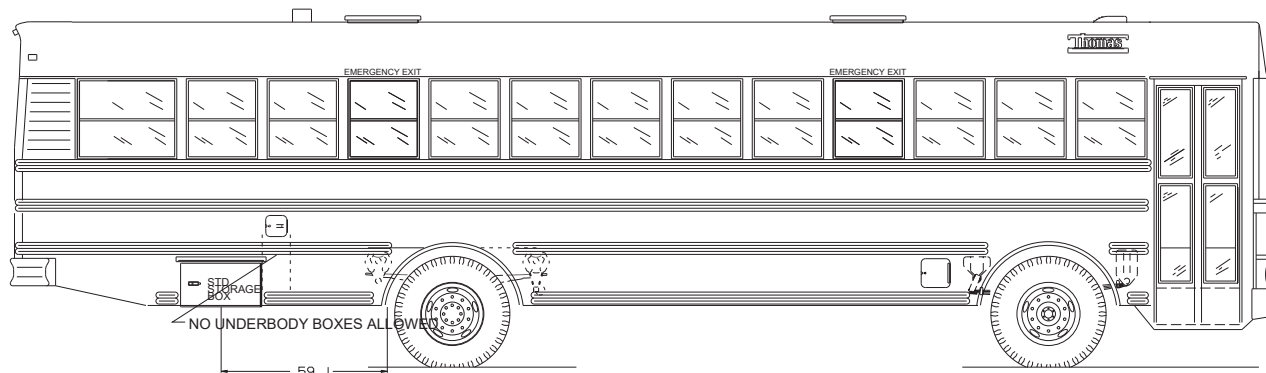

ALL DIMENSIONS ARE FOR REFERENCE ONLY

GENERAL NOTES

- SOME ITEMS, SUCH AS CV MIRRORS, ROOF LUGGAGE RACKS, AND OTHER ITEMS, ARE SHOWN IN ONE VIEW ONLY FOR CLARITY.
- THIS DRAWING IS A REPRESENTATION ONLY AND MAY NOT HAVE ALL ITEMS REQUIRED. PLEASE REFER TO ORDER!
- THE CLEARANCE BETWEEN BOTTOM OF BUS OR BOTTOM OF UNDERBODY COMPARTMENTS AND GROUND WILL VARY ACCORDING TO TIRE SIZE, BUS LOAD, AND SUSPENSION TYPE.
- THE MAXIMUM WIDTH AT BELT LINE OVER GUARD RAILS IS 96".
- THE MAXIMUM BUS HEIGHT IS BASED ON A STANDARD BODY AND LARGEST SIZE TIRE.
- THE MAXIMUM BUS HEIGHT IS BASED ON BODY WITH OPTIONS SUCH AS A/C UNITS, STROBE LIGHT, AIR-DRY SUSPENSION ETC.
- OVER BUMPER DIMENSION DOES NOT TAKE INTO ACCOUNT OPTIONS THAT MAY ADD TO THE TOTAL LENGTH OF THE BUS, SUCH AS MIRRORS, LIGHTS, AND CROSSING ARMS.

Model: MVP-EF
 Quote Number: 388040
 Locality: KY

THIS DRAWING AND ALL INFORMATION PROVIDED WITH IT ARE THE PROPERTY OF THOMAS BUILT BUSES, INC. ANY REPRODUCTION OR DISTRIBUTION OF THIS MATERIAL OR ANY PART WITHOUT WRITTEN PERMISSION OF THOMAS BUILT BUSES, INC. IS STRICTLY PROHIBITED. COPYRIGHT THOMAS BUILT BUSES, INC.

SIDE	ROW	SPACING	WHEEL BASE	WHEEL
LEFT		30.1	28.8	
LEFT		26.3	25.0	
LEFT		28.0	24.7	
RIGHT		27.7	26.4	
RIGHT		27.4	26.1	

TITLE		PLAN AND ELEVATION	
BODY 1318S		HIGH POINT, NC	
DRN-05-24-22	BY: T. Dean	SIZE	DWG. NO.
SCALE 3/8"=12"		S	859384

SEATING CAPACITY: 84 + DRIVER

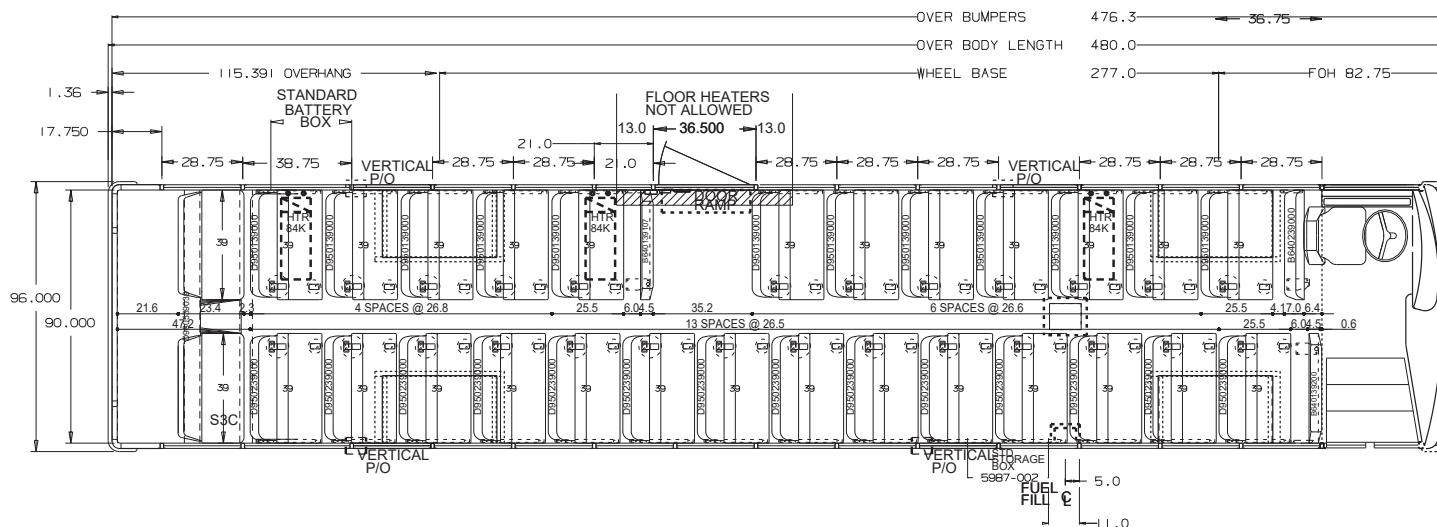
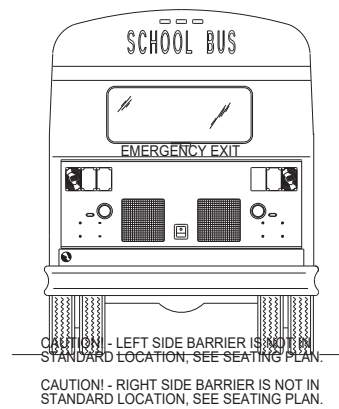
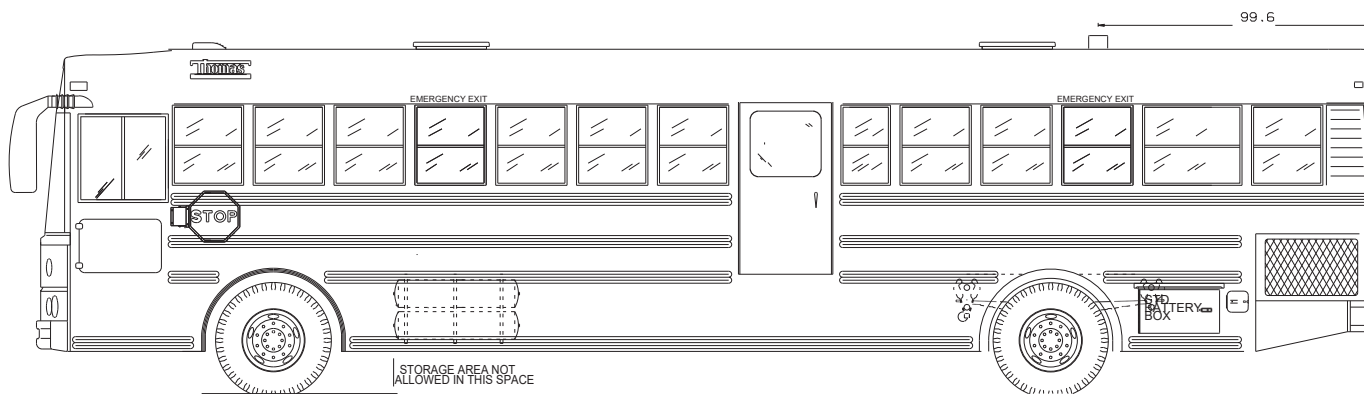

EQUIPPED WITH ALLISON TRANSMISSION

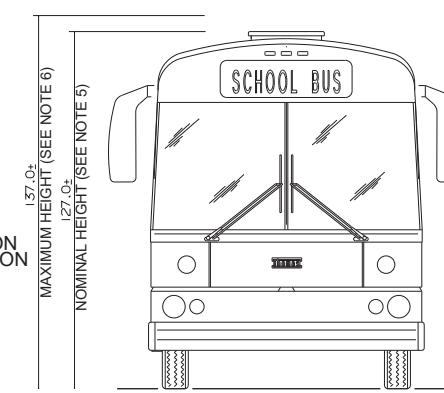

NOTES:
UNIT EQUIPPED WITH PLYWOOD FLOOR

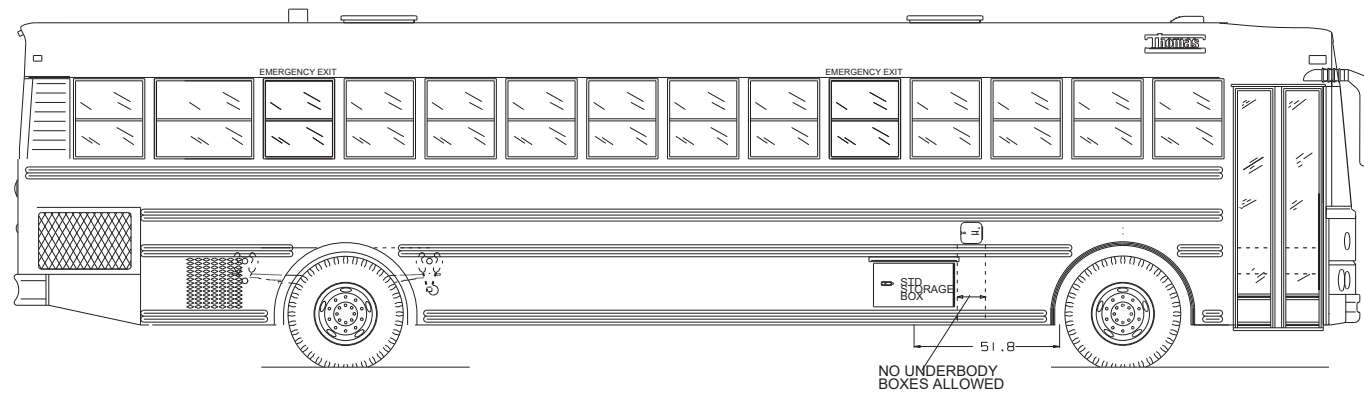

ALL DIMENSIONS ARE FOR REFERENCE ONLY

- GENERAL NOTES**
- SOME ITEMS, SUCH AS CV MIRRORS, ROOF LUGGAGE RACKS, AND OTHER ITEMS, ARE SHOWN IN ONE VIEW ONLY FOR CLARITY.
 - THIS DRAWING IS A REPRESENTATION ONLY AND MAY NOT HAVE ALL ITEMS REQUIRED. PLEASE REFER TO ORDER!
 - THE CLEARANCE BETWEEN BOTTOM OF BUS OR BOTTOM OF UNDERBODY COMPARTMENTS AND GROUND WILL VARY ACCORDING TO THE SIZE, BUS LOAD, AND SUSPENSION TYPE.
 - THE MAXIMUM WIDTH AT BELT LINE OVER GUARD RAILS IS 96".
 - THE MAXIMUM BUS HEIGHT IS BASED ON A STANDARD BODY AND LARGEST SIZE TIRE.
 - THE MAXIMUM BUS HEIGHT IS BASED ON BODY WITH OPTIONS SUCH AS A/C UNITS, STROBE LIGHT, CARGO SUSPENSION ETC.
 - OVER BUMPER DIMENSION DOES NOT TAKE INTO ACCOUNT OPTIONS THAT MAY ADD TO THE TOTAL LENGTH OF THE BUS, SUCH AS MIRRORS, LIGHTS AND CROSSING ARMS.
- THIS DRAWING AND ALL INFORMATION PROVIDED WITH IT ARE THE PROPERTY OF THOMAS BUILT BUSES, INC. ANY REPRODUCTION OR DISTRIBUTION OF THIS MATERIAL OR ANY PART WITHOUT WRITTEN PERMISSION OF THOMAS BUILT BUSES, INC. IS STRICTLY PROHIBITED. COPYRIGHT THOMAS BUILT BUSES, INC.

Model: Saf-T-Liner HDX
Quote Number: 398075
Locality: KY

SIDE	ROW	SPACING	WHEEL RACK
LEFT		26.6	25.1
LEFT		26.8	25.3
RIGHT		26.5	25.0

DRN:05-24-23	BY:T. Dean	SIZE	DWG. NO.
SCALE 3/8"=12"		S	877251

THOMAS BUILT BUSES, INC.
HIGH POINT, NC
TITLE: **PLAN AND ELEVATION BODY 141YS**

SEATING CAPACITY: 78 + DRIVER

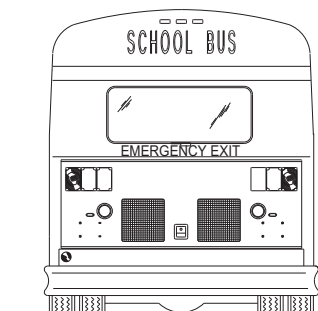
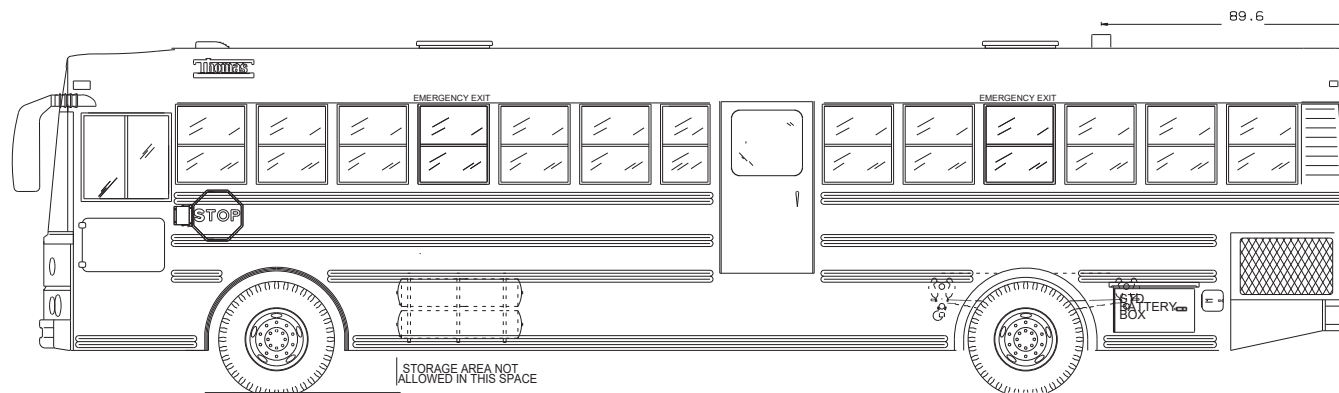

CAUTION - LEFT SIDE BARRIER IS NOT IN STANDARD LOCATION, SEE SEATING PLAN.
 CAUTION! - RIGHT SIDE BARRIER IS NOT IN STANDARD LOCATION, SEE SEATING PLAN.

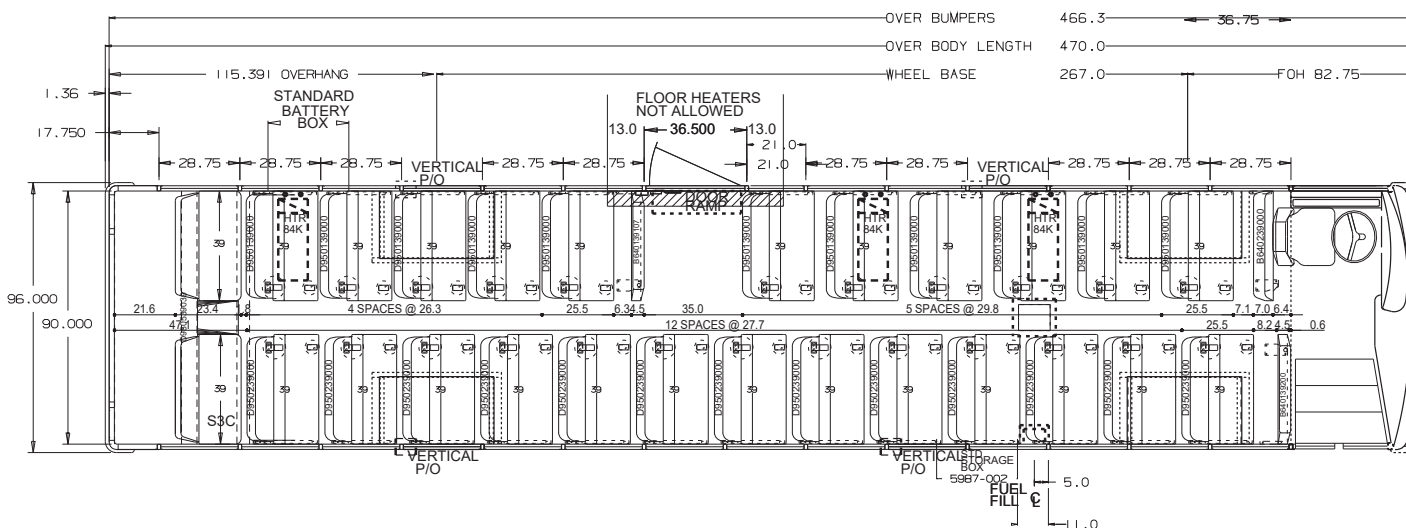

EQUIPPED WITH ALLISON TRANSMISSION

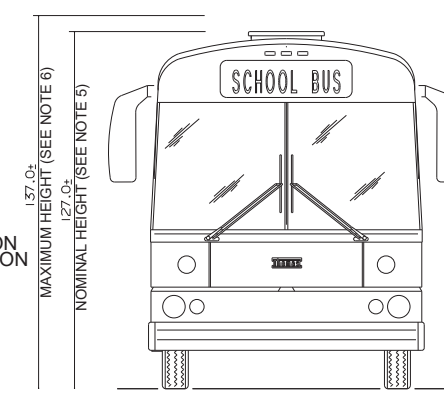

NOTES:
 UNIT EQUIPPED WITH PLYWOOD FLOOR

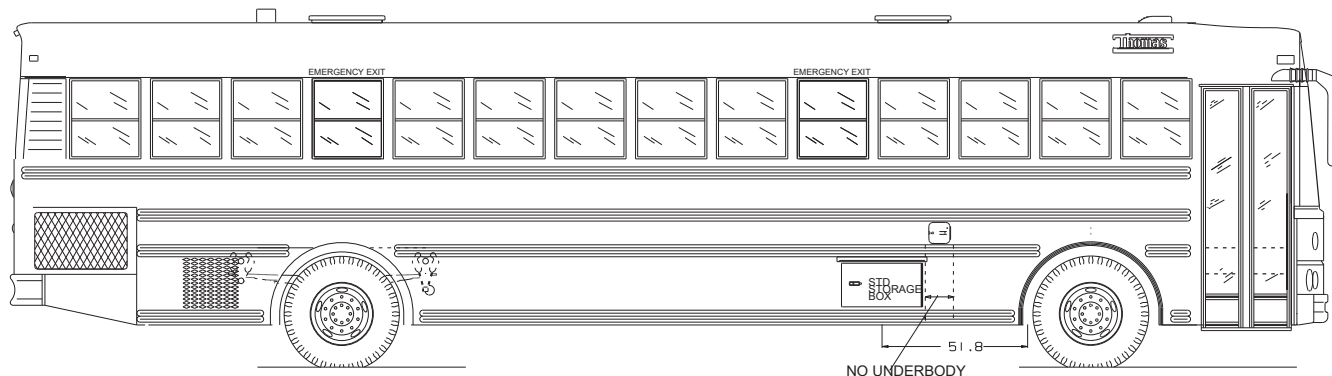

ALL DIMENSIONS ARE FOR REFERENCE ONLY

- GENERAL NOTES**
- SOME ITEMS, SUCH AS CV MIRRORS, ROOF LUGGAGE RACKS, AND OTHER ITEMS, ARE SHOWN IN ONE VIEW ONLY FOR CLARITY.
 - THIS DRAWING IS A REPRESENTATION ONLY AND MAY NOT HAVE ALL ITEMS REQUIRED. PLEASE REFER TO ORDER!
 - THE CLEARANCE BETWEEN BOTTOM OF BUS OR BOTTOM OF UNDERBODY COMPARTMENTS AND GROUND WILL VARY ACCORDING TO THE SIZE, BUS LOAD, AND SUSPENSION TYPE.
 - THE MAXIMUM WIDTH AT BELT LINE OVER GUARD RAILS IS 96".
 - THE MAXIMUM BUS HEIGHT IS BASED ON A STANDARD BODY AND LARGEST SIZE TIRE.
 - THE MAXIMUM BUS HEIGHT IS BASED ON BODY WITH OPTIONS SUCH AS A/C UNITS, STROBE LIGHT, CARGO SUSPENSION ETC.
 - OVER BUMPER DIMENSION DOES NOT TAKE INTO ACCOUNT OPTIONS THAT MAY AFFECT THE TOTAL LENGTH OF THE BUS, SUCH AS MIRRORS, LIGHTS AND CROSSING ARMS.
- THIS DRAWING AND ALL INFORMATION PROVIDED WITH IT ARE THE PROPERTY OF THOMAS BUILT BUSES, INC. ANY REPRODUCTION OR DISTRIBUTION OF THIS MATERIAL OR ANY PART WITHOUT WRITTEN PERMISSION OF THOMAS BUILT BUSES, INC. IS STRICTLY PROHIBITED. COPYRIGHT THOMAS BUILT BUSES, INC.

Model: Saf-T-Liner HDX
 Quote Number: 398076
 Locality: KY

SIDE	ROW	SPACING	WHEEL RACK
LEFT		29.8	28.3
LEFT		26.3	24.8
RIGHT		27.7	26.2

DRN: 05-24-23	BY: T. Dean	SIZE	DWG. NO.
SCALE 3/8"=12"		S	877252

THOMAS BUILT BUSES, INC.
 HIGH POINT, NC
PLAN AND ELEVATION BODY 140YS

SEATING CAPACITY: 78 + DRIVER

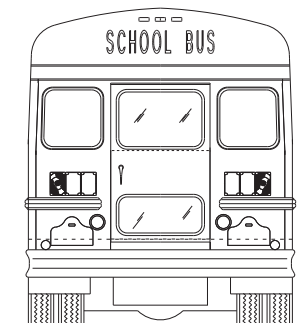
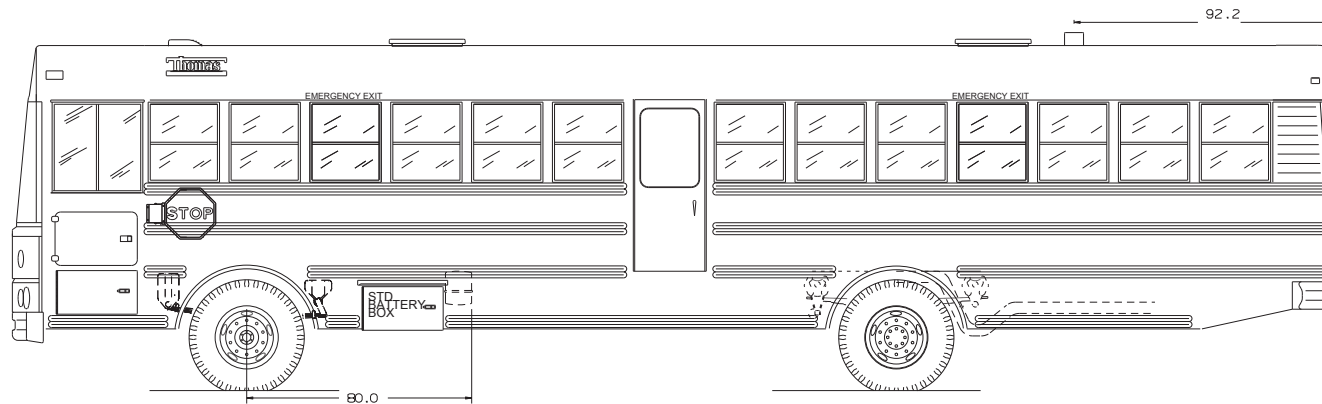

CAUTION - LEFT SIDE BARRIER IS NOT IN STANDARD LOCATION, SEE SEATING PLAN.
 CAUTION! - RIGHT SIDE BARRIER IS NOT IN STANDARD LOCATION, SEE SEATING PLAN.

EQUIPPED WITH 23K SUSPENSION

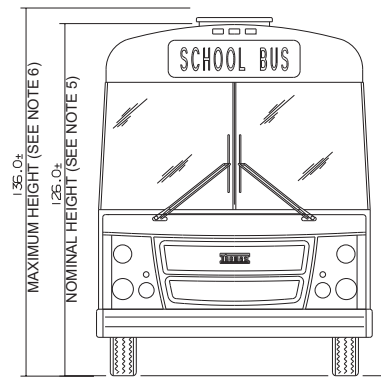
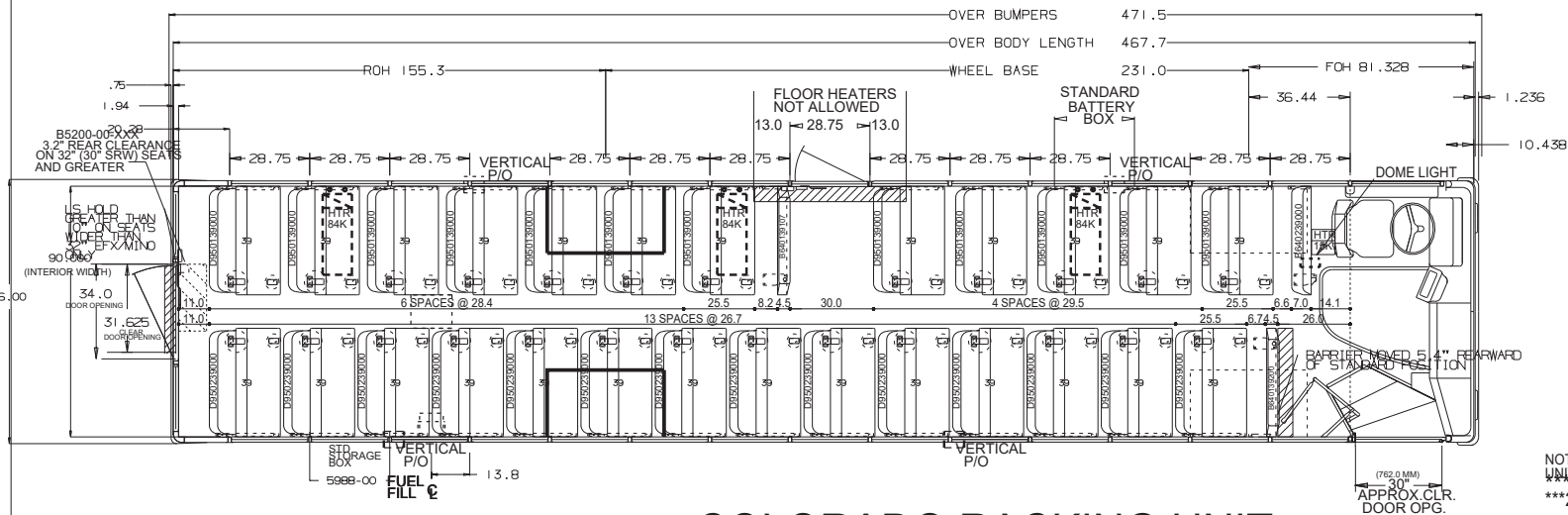

NOTES:
 UNIT EQUIPPED WITH HLYWOOD FLOOR
 23K REAR SUSPENSION

COLORADO RACKING UNIT

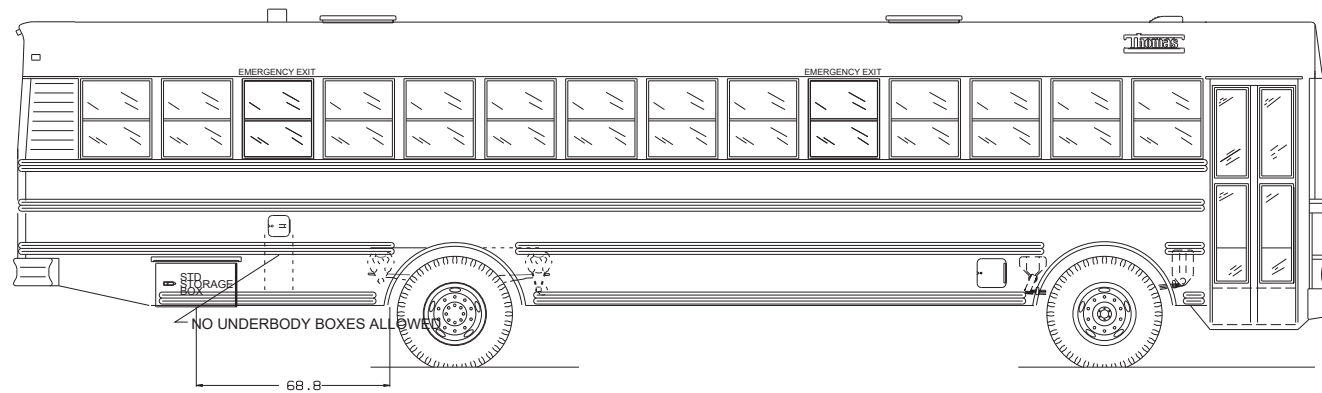

ALL DIMENSIONS ARE FOR REFERENCE ONLY

GENERAL NOTES

- SOME ITEMS, SUCH AS CV MIRRORS, ROOF LUGGAGE RACKS, AND OTHER ITEMS, ARE SHOWN IN ONE VIEW ONLY FOR CLARITY.
- THIS DRAWING IS A REPRESENTATION ONLY AND MAY NOT HAVE ALL ITEMS REQUIRED. PLEASE REFER TO ORDER!
- THE CLEARANCE BETWEEN BOTTOM OF BUS OR BOTTOM OF UNDERBODY COMPARTMENTS AND GROUND WILL VARY ACCORDING TO TIRE SIZE, BUS LOAD, AND SUSPENSION TYPE.
- THE MAXIMUM WIDTH AT BELT LINE OVER GUARD RAILS IS 96".
- THE MAXIMUM BUS HEIGHT IS BASED ON A STANDARD BODY AND LARGEST SIZE TIRE.
- THE MAXIMUM BUS HEIGHT IS BASED ON BODY WITH OPTIONS SUCH AS A/C UNITS, STROBE LIGHT, AIR-DRY SUSPENSION ETC.
- OVER BUMPER DIMENSION DOES NOT TAKE INTO ACCOUNT OPTIONS THAT MAY ADD TO THE TOTAL LENGTH OF THE BUS, SUCH AS MIRRORS, LIGHTS, AND CROSSING ARMS.

Model: MVP-EF
 Quote Number: 398077
 Locality: KY

THIS DRAWING AND ALL INFORMATION PROVIDED WITH IT ARE THE PROPERTY OF THOMAS BUILT BUSES, INC. ANY REPRODUCTION OR DISTRIBUTION OF THIS MATERIAL OR ANY PART WITHOUT WRITTEN PERMISSION OF THOMAS BUILT BUSES, INC. IS STRICTLY PROHIBITED. COPYRIGHT THOMAS BUILT BUSES, INC.

SIDE	ROW	SPACING	WHEEL BASE	WHEEL CENTER
LEFT		29.5	28.0	
LEFT		28.4	26.9	
RIGHT		26.7	25.2	

TITLE	PLAN AND ELEVATION BODY 1408S
DRN	07-10-23 BY:T. Dean
SCALE	3/8"=12"
SIZE	DWG. NO. 877253

SEATING CAPACITY: 34 + DRIVER

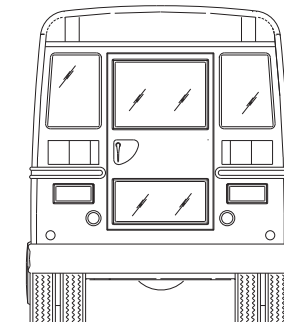
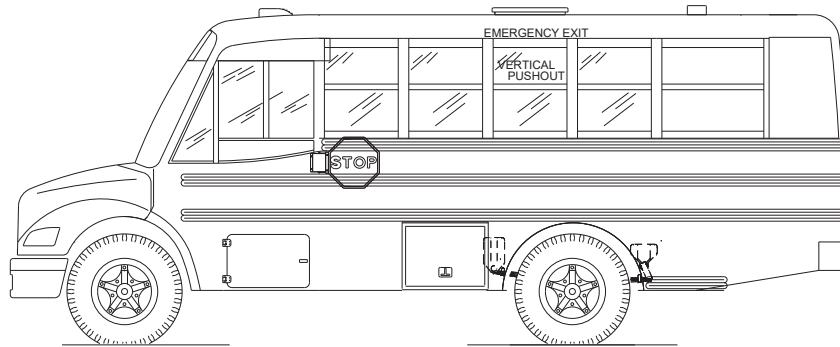

CAUTION - LEFT SIDE BARRIER IS NOT IN STANDARD LOCATION, SEE SEATING PLAN.

CAUTION! - RIGHT SIDE BARRIER IS NOT IN STANDARD LOCATION, SEE SEATING PLAN.

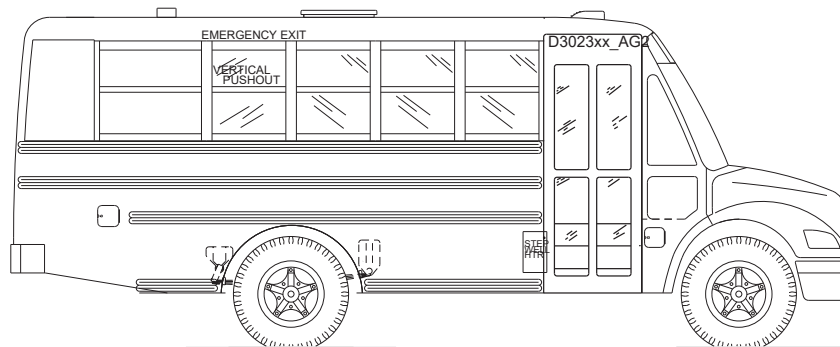
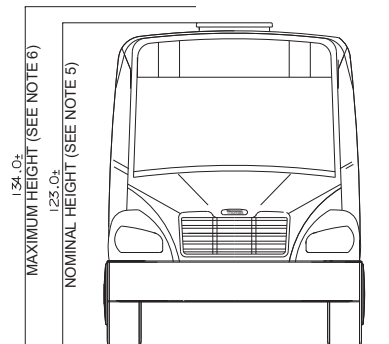
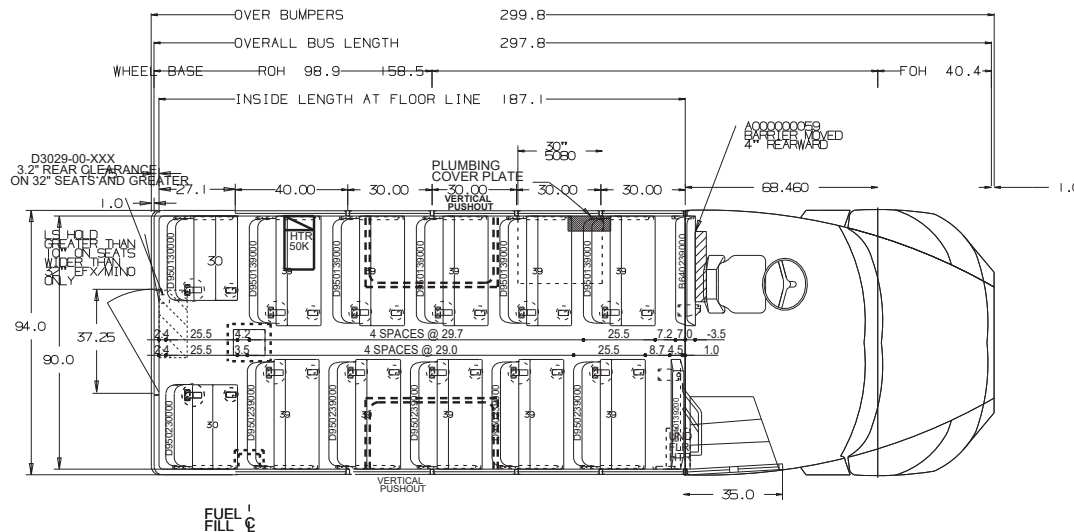

ALL DIMENSIONS ARE FOR REFERENCE ONLY

GENERAL NOTES

- SOME ITEMS, SUCH AS CV MIRRORS, ROOF LUGGAGE RACKS, AND OTHER ITEMS, ARE SHOWN IN ONE VIEW ONLY FOR CLARITY.
- THIS DRAWING IS A REPRESENTATION ONLY AND MAY NOT HAVE ALL ITEMS REQUIRED. PLEASE REFER TO ORDER!
- THE CLEARANCE BETWEEN BOTTOM OF BUS OR BOTTOM OF UNDERBODY COMPARTMENTS AND GROUND WILL VARY ACCORDING TO TIRE SIZE, BUS LOAD, AND SUSPENSION TYPE.
- THE MAXIMUM WIDTH AT BELT LINE OVER GUARD RAILS IS 96".
- THE NOMINAL BUS HEIGHT IS BASED ON A STANDARD BODY AND LARGEST SIZE TIRE.
- THE MAXIMUM BUS HEIGHT IS BASED ON BODY WITH OPTIONS SUCH AS A/C UNITS, STROBE LIGHT, LARGEST SUSPENSION ETC.
- COVER BUMPER DIMENSION DOES NOT TAKE INTO ACCOUNT OPTIONS THAT MAY ADD TO THE TOTAL LENGTH OF THE BUS, SUCH AS MIRRORS, LIGHTS AND CROSSING ARMS.

THIS DRAWING AND ALL INFORMATION PROVIDED WITH IT ARE THE PROPERTY OF THOMAS BUILT BUSES, INC. ANY REPRODUCTION OR DISTRIBUTION OF THIS MATERIAL OR ANY PART WITHOUT WRITTEN PERMISSION OF THOMAS BUILT BUSES, INC. IS STRICTLY PROHIBITED. COPYRIGHT THOMAS BUILT BUSES, INC.

Model: Saf-T-Liner C2
Quote Number: 398102
Locality: US KY

SIDE	ROW	SPACING	WHEEL RADIUS
LEFT		29.7	28.2
RIGHT		29.0	27.5

THOMAS BUILT BUSES, INC.
HIGH POINT, NC

TITLE **PLAN AND ELEVATION BODY 161TS**

DRN: 05-23-23 BY: T. Dean SIZE DWG. NO. **877285**

SCALE 3/8"=12" S **877285**

SEATING CAPACITY: 30 + 4 WC + DRIVER

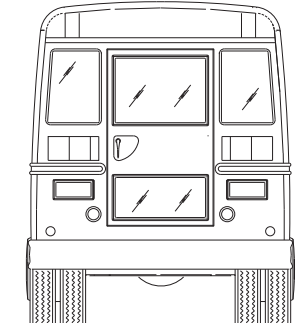
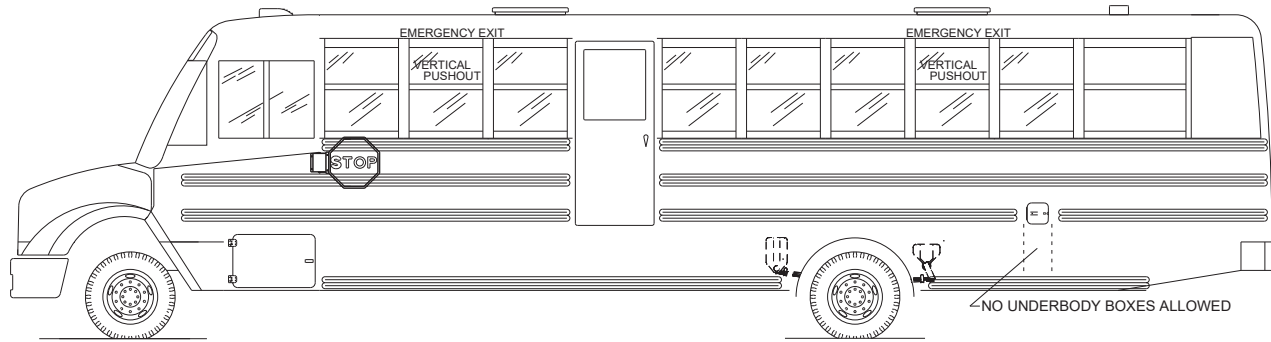

CAUTION - LEFT SIDE BARRIER IS NOT IN STANDARD LOCATION, SEE SEATING PLAN.

CAUTION! - RIGHT SIDE BARRIER IS NOT IN STANDARD LOCATION, SEE SEATING PLAN.

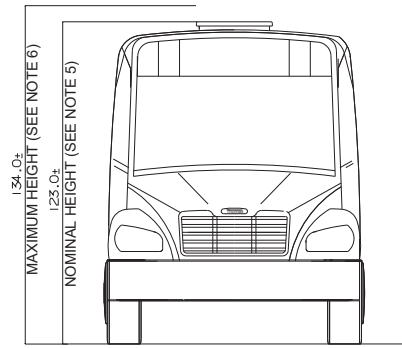
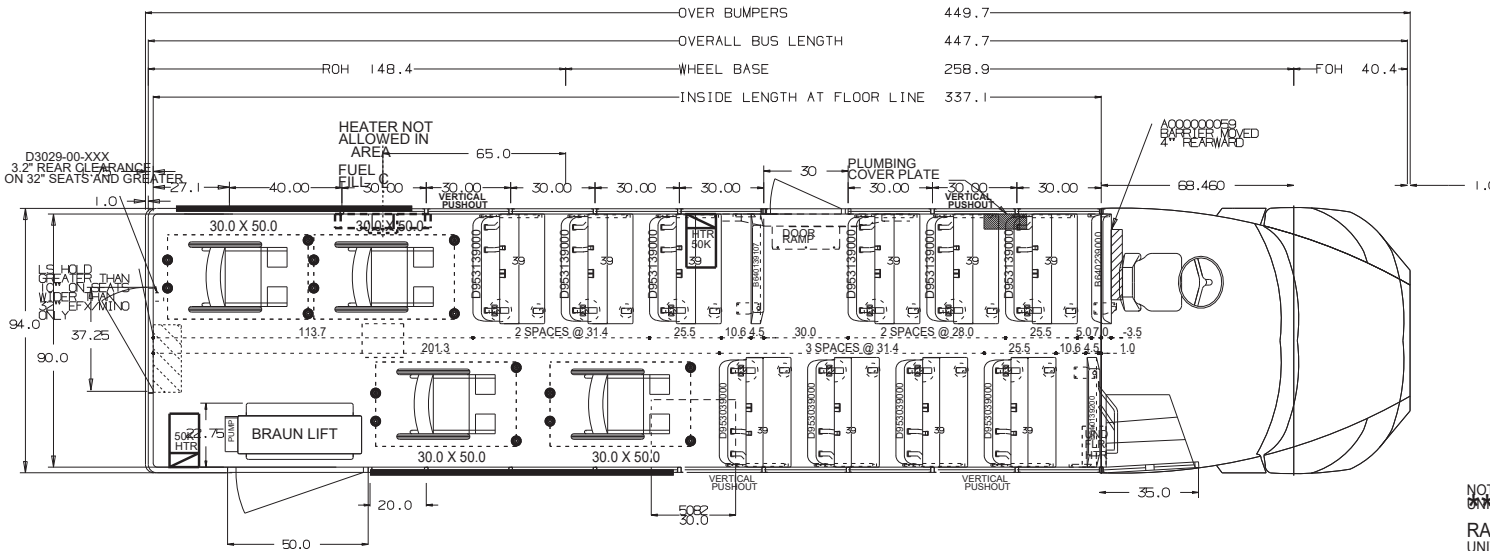

NOTES:
 1. OVERHEAD REINFORCEMENT RAFTER CONFIG D2000-00-716 (120312)
 UNIT IS CONFIGURED WITH A FLAT FLOOR

ALL DIMENSIONS ARE FOR REFERENCE ONLY

Model: Saf-T-Liner C2
 Quote Number: 398103
 Locality: KY

- GENERAL NOTES
- SOME ITEMS, SUCH AS CV MIRRORS, ROOF LUGGAGE RACKS, AND OTHER ITEMS, ARE SHOWN IN ONE VIEW ONLY FOR CLARITY.
 - THIS DRAWING IS A REPRESENTATION ONLY AND MAY NOT HAVE ALL ITEMS REQUIRED. PLEASE REFER TO ORDER!
 - THE CLEARANCE BETWEEN BOTTOM OF BUS OR BOTTOM OF UNDERBODY COMPARTMENTS AND GROUND WILL VARY ACCORDING TO THE SIZE, BUS LOAD, AND SUSPENSION TYPE.
 - THE MAXIMUM WIDTH AT BELT LINE OVER GUARD RAILS IS 96".
 - THE NOMINAL BUS HEIGHT IS BASED ON A STANDARD BODY AND LARGEST SIZE TIRE.
 - THE MAXIMUM BUS HEIGHT IS BASED ON BODY WITH OPTIONS SUCH AS A/C UNITS, STROBE LIGHT, CARGO SUSPENSION ETC.
 - OVER BUMPER DIMENSION DOES NOT TAKE INTO ACCOUNT OPTIONS THAT MAY ADD TO THE TOTAL LENGTH OF THE BUS, SUCH AS MIRRORS, LIGHTS AND CROSSING ARMS.
- THIS DRAWING AND ALL INFORMATION PROVIDED WITH IT ARE THE PROPERTY OF THOMAS BUILT BUSES, INC. ANY REPRODUCTION OR DISTRIBUTION OF THIS MATERIAL OR ANY PART WITHOUT WRITTEN PERMISSION OF THOMAS BUILT BUSES, INC. IS STRICTLY PROHIBITED.
 COPYRIGHT THOMAS BUILT BUSES, INC.

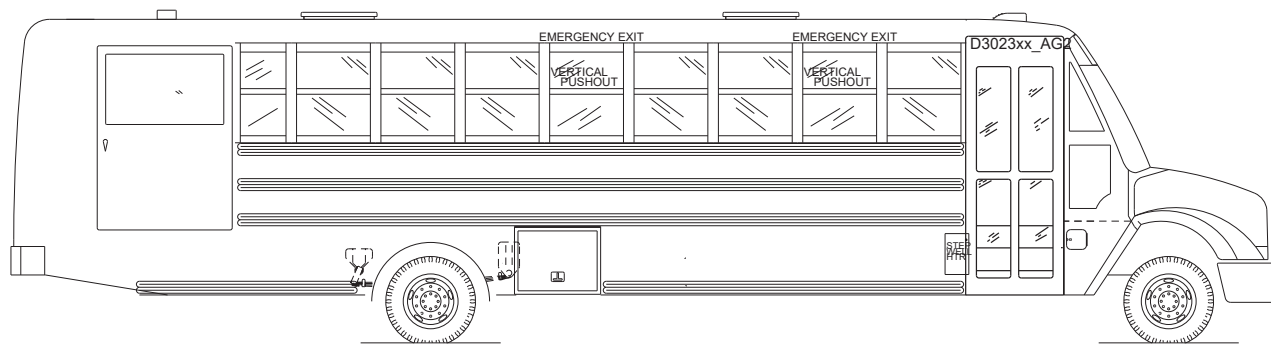

SIDE	ROW	SPACING	WHEEL RISE	WHEEL
LEFT		28.0	26.5	
LEFT		31.4	29.9	
RIGHT		31.4	29.9	

THOMAS BUILT BUSES, INC.
 HIGH POINT, NC

TITLE: PLAN AND ELEVATION BODY 311TS

DRN: 05-26-23 BY: T. Dean SIZE: DWG. NO. 877287

SCALE: 3/8"=12" S

SEATING CAPACITY: 20 + 4 WC + DRIVER

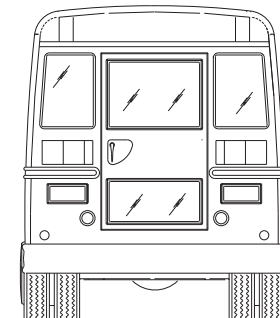
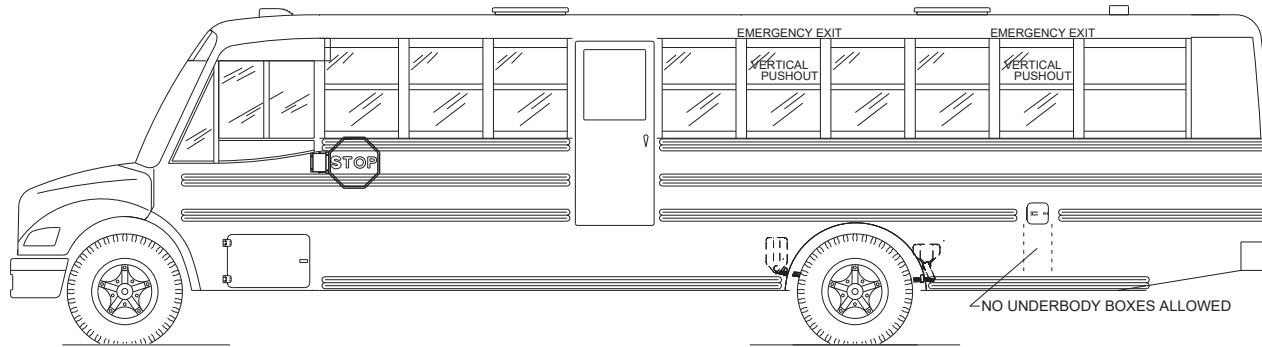

CAUTION - LEFT SIDE BARRIER IS NOT IN STANDARD LOCATION, SEE SEATING PLAN.

CAUTION! - RIGHT SIDE BARRIER IS NOT IN STANDARD LOCATION, SEE SEATING PLAN.

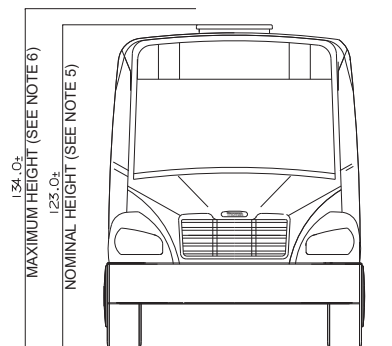
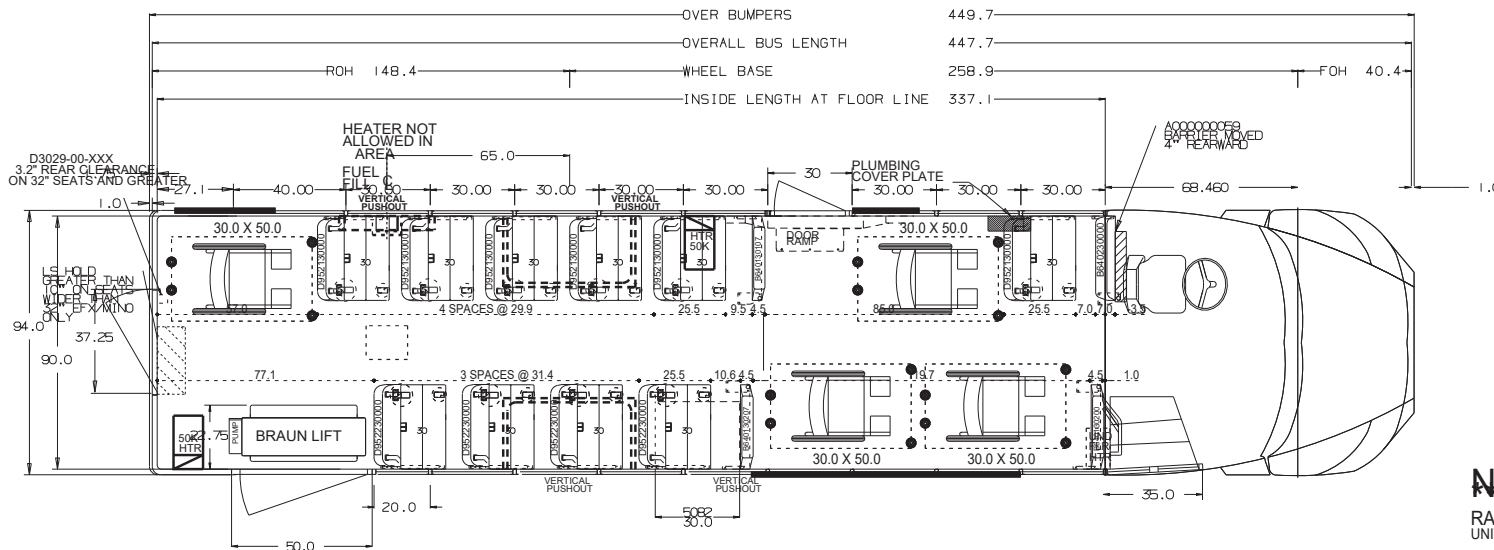

NOTES: DEMO UNIT***

RAFTER CONFIG D2000-00-716 (120312)
UNIT EQUIPPED WITH OVERHEAD TRACK REINFORCEMENT

ALL DIMENSIONS ARE FOR REFERENCE ONLY

GENERAL NOTES

- SOME ITEMS, SUCH AS CV MIRRORS, ROOF LUGGAGE RACKS, AND OTHER ITEMS, ARE SHOWN IN ONE VIEW ONLY FOR CLARITY.
- THIS DRAWING IS A REPRESENTATION ONLY AND MAY NOT HAVE ALL ITEMS REQUIRED. PLEASE REFER TO ORDER!
- THE CLEARANCE BETWEEN BOTTOM OF BUS OR BOTTOM OF UNDERBODY COMPARTMENTS AND GROUND WILL VARY ACCORDING TO TIRE SIZE, BUS LOAD, AND SUSPENSION TYPE.
- THE MAXIMUM WIDTH AT BELT LINE OVER GUARD RAILS IS 96".
- THE NOMINAL BUS HEIGHT IS BASED ON A STANDARD BODY AND LARGEST SIZE TIRE.
- THE MAXIMUM BUS HEIGHT IS BASED ON BODY WITH OPTIONS SUCH AS A/C UNITS, STROBE LIGHT, CARGO SUSPENSION ETC.
- OVER BUMPER DIMENSION DOES NOT TAKE INTO ACCOUNT OPTIONS THAT MAY ADD TO THE TOTAL LENGTH OF THE BUS, SUCH AS MIRRORS, LIGHTS AND CROSSING ARMS.

THIS DRAWING AND ALL INFORMATION PROVIDED WITH IT ARE THE PROPERTY OF THOMAS BUILT BUSES, INC. ANY REPRODUCTION OR DISTRIBUTION OF THIS MATERIAL OR ANY PART WITHOUT WRITTEN PERMISSION OF THOMAS BUILT BUSES, INC. IS STRICTLY PROHIBITED. COPYRIGHT THOMAS BUILT BUSES, INC.

Model: Saf-T-Liner C2
Quote Number: 398117
Locality: KY

SIDE	ROW	SPACING	WHEEL BASE
LEFT		29.9	28.4
RIGHT		31.4	29.9

THOMAS BUILT BUSES, INC.
HIGH POINT, NC

TITLE PLAN AND ELEVATION BODY 311TS

DRN: 05-25-23 BY: T. Dean SIZE DWG. NO.
SCALE 3/8"=12" S 877299

SEATING CAPACITY: 21 + 2 WC + DRIVER

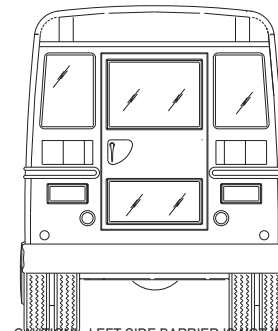
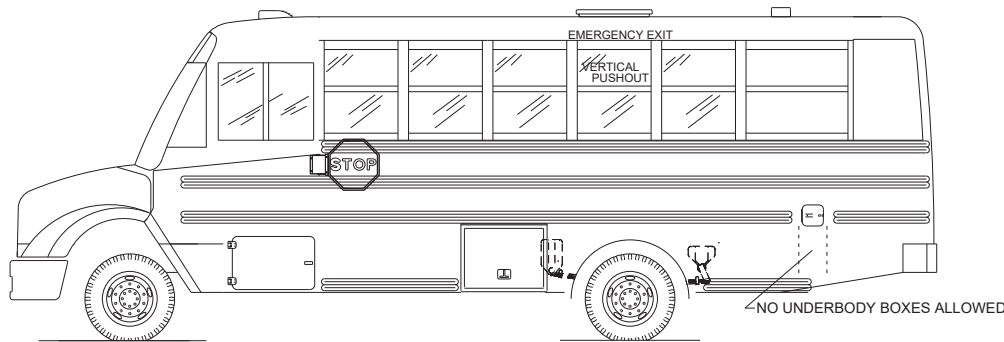

CAUTION - LEFT SIDE BARRIER IS NOT IN STANDARD LOCATION, SEE SEATING PLAN.

CAUTION! - RIGHT SIDE BARRIER IS NOT IN STANDARD LOCATION, SEE SEATING PLAN.

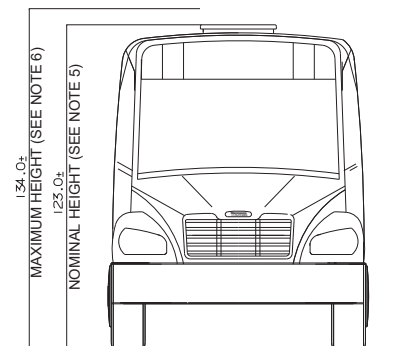
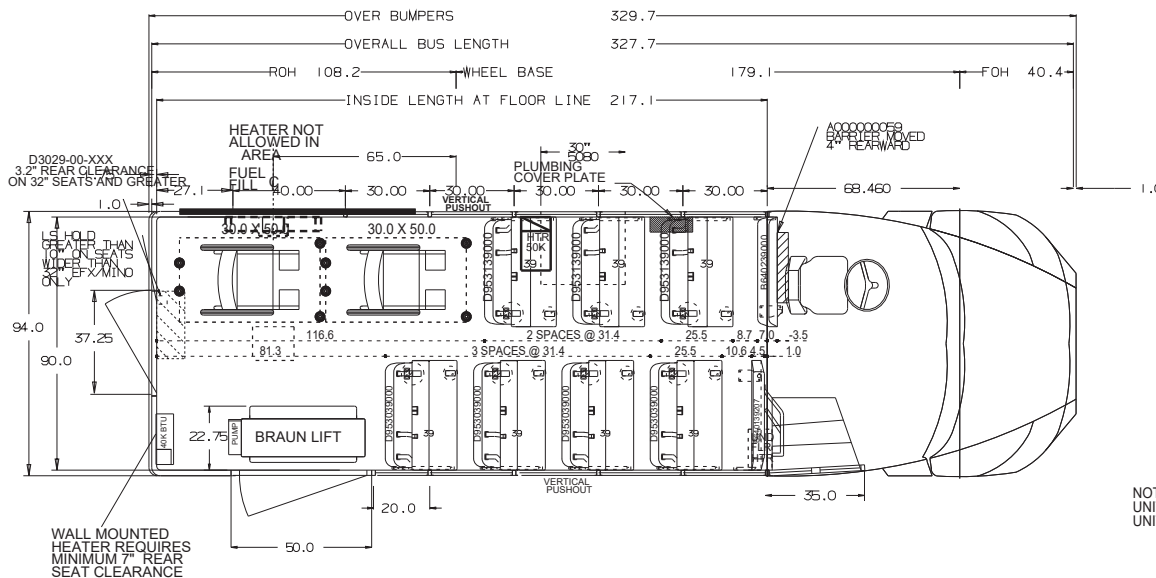

NOTES:
UNIT IS CONFIGURED WITH A FLAT FLOOR
UNIT EQUIPPED WITH OVERHEAD TRACK REINFORCEMENT

ALL DIMENSIONS ARE FOR REFERENCE ONLY

GENERAL NOTES

- SOME ITEMS, SUCH AS CV MIRRORS, ROOF LUGGAGE RACKS, AND OTHER ITEMS, ARE SHOWN IN ONE VIEW ONLY FOR CLARITY.
- THIS DRAWING IS A REPRESENTATION ONLY AND MAY NOT HAVE ALL ITEMS REQUIRED. PLEASE REFER TO ORDER!
- THE CLEARANCE BETWEEN BOTTOM OF BUS OR BOTTOM OF UNDERBODY COMPARTMENTS AND GROUND WILL VARY ACCORDING TO TIRE SIZE, BUS LOAD, AND SUSPENSION TYPE.
- THE MAXIMUM WIDTH AT BELT LINE OVER GUARD RAILS IS 96".
- THE NOMINAL BUS HEIGHT IS BASED ON A STANDARD BODY AND LARGEST SIZE TIRE.
- THE MAXIMUM BUS HEIGHT IS BASED ON BODY WITH OPTIONS SUCH AS A/C UNITS, STROBE LIGHT, LARGER SUSPENSION ETC.
- OVER BUMPER DIMENSION DOES NOT TAKE INTO ACCOUNT OPTIONS THAT MAY ADD TO THE TOTAL LENGTH OF THE BUS, SUCH AS MIRRORS, LIGHTS AND CROSSING ARMS.

THIS DRAWING AND ALL INFORMATION PROVIDED WITH IT ARE THE PROPERTY OF THOMAS BUILT BUSES, INC. ANY REPRODUCTION OR DISTRIBUTION OF THIS MATERIAL OR ANY PART WITHOUT WRITTEN PERMISSION OF THOMAS BUILT BUSES, INC. IS STRICTLY PROHIBITED. COPYRIGHT THOMAS BUILT BUSES, INC.

Model: Saf-T-Liner C2
Quote Number: 398138
Locality: KY

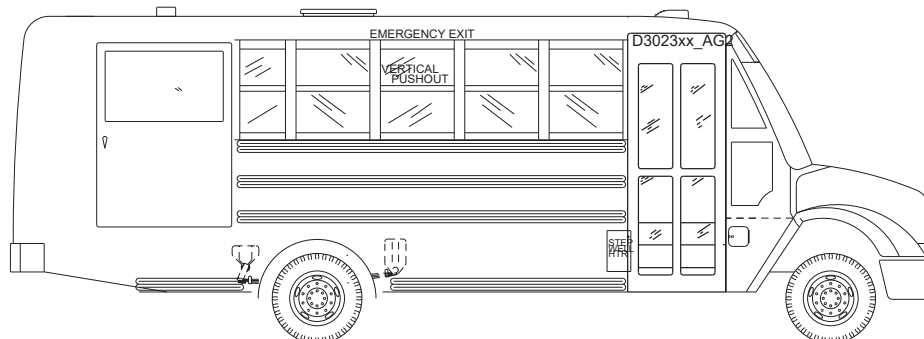

SIDE	ROW	SPACING	WHEEL RACK
LEFT		31.4	29.9
RIGHT		31.4	29.9

TITLE	PLAN AND ELEVATION BODY 191TS
DRN:05-24-23	BY:T. Dean
SCALE	3/8"=12"
SIZE	S
DWG. NO.	877314

THOMAS BUILT BUSES, INC. HIGH POINT, NC

SEATING CAPACITY: 20 + 4 WC + DRIVER

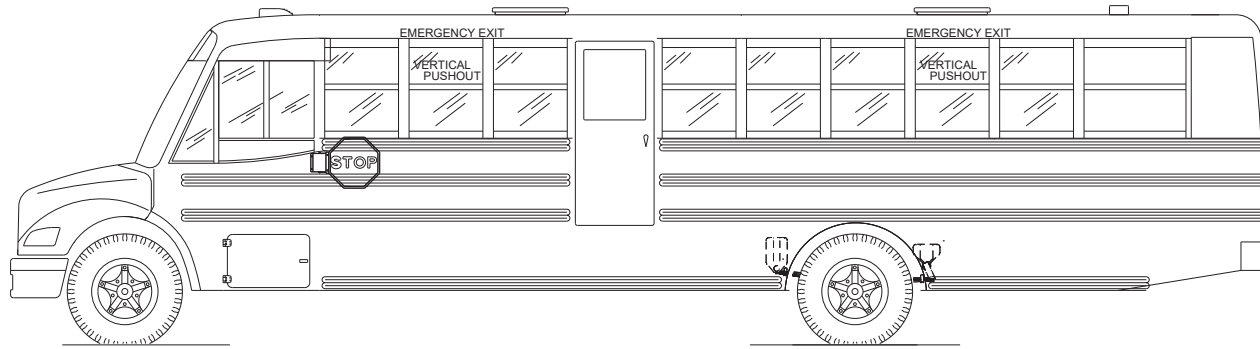

*****EV UNIT: NOTE S.T.A.R.S. LOCATIONS*****

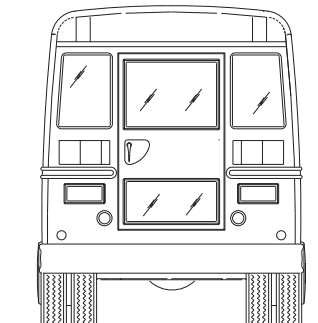

CAUTION - LEFT SIDE BARRIER IS NOT IN STANDARD LOCATION, SEE SEATING PLAN.
CAUTION! - RIGHT SIDE BARRIER IS NOT IN STANDARD LOCATION, SEE SEATING PLAN.

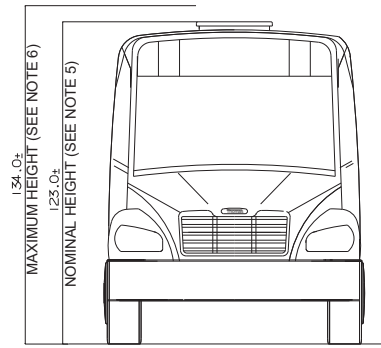
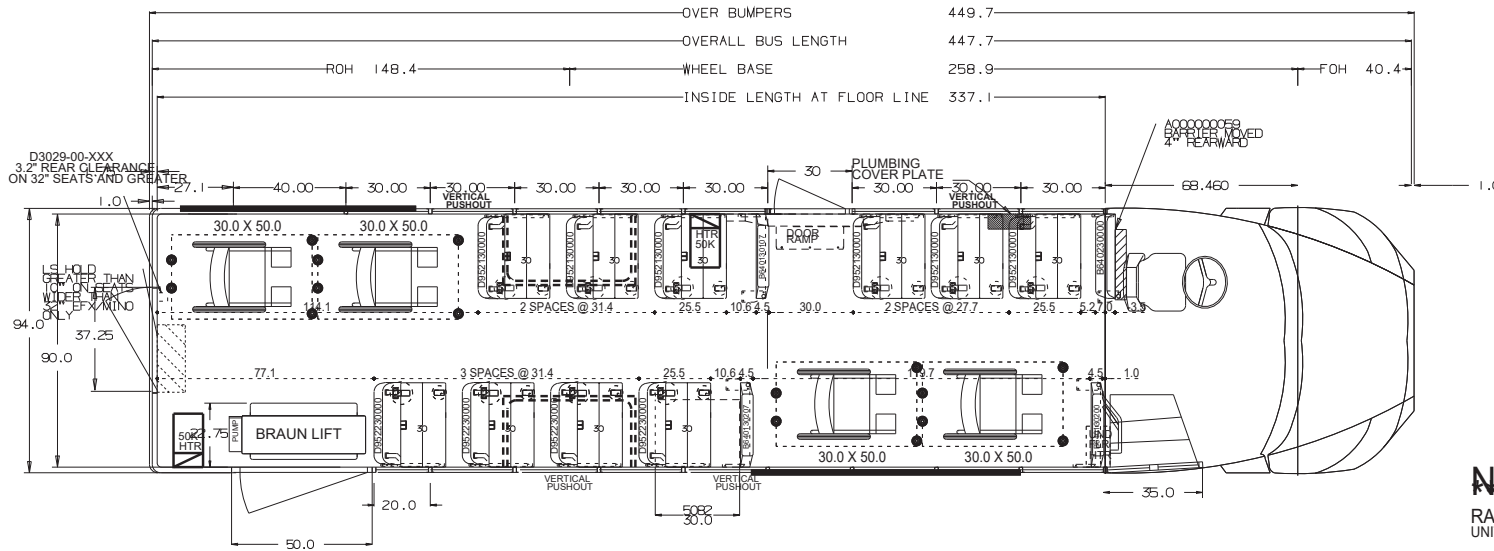

NOTES: DEMO UNIT***
RAFTER CONFIG D2000-00-716 (120312)
UNIT EQUIPPED WITH OVERHEAD TRACK REINFORCEMENT

ALL DIMENSIONS ARE FOR REFERENCE ONLY

GENERAL NOTES

1. SOME ITEMS, SUCH AS CV MIRRORS, ROOF LUGGAGE RACKS, AND OTHER ITEMS, ARE SHOWN IN ONE VIEW ONLY FOR CLARITY.
2. THIS DRAWING IS A REPRESENTATION ONLY AND MAY NOT HAVE ALL ITEMS REQUIRED. PLEASE REFER TO ORDER!
3. THE CLEARANCE BETWEEN BOTTOM OF BUS OR BOTTOM OF UNDERBODY COMPARTMENTS AND GROUND WILL VARY ACCORDING TO TIRE SIZE, BUS LOAD, AND SUSPENSION TYPE.
4. THE MAXIMUM WIDTH AT BELT LINE OVER GUARD RAILS IS 96".
5. THE NOMINAL BUS HEIGHT IS BASED ON A STANDARD BODY AND LARGEST SIZE TIRE.
6. THE MAXIMUM BUS HEIGHT IS BASED ON BODY WITH OPTIONS SUCH AS A/C UNITS, STROBE LIGHT, CARGO SUSPENSION ETC.
7. OVER BUMPER DIMENSION DOES NOT TAKE INTO ACCOUNT OPTIONS THAT MAY ADD TO THE TOTAL LENGTH OF THE BUS, SUCH AS MIRRORS, LIGHTS AND CROSSING ARMS.

THIS DRAWING AND ALL INFORMATION PROVIDED WITH IT ARE THE PROPERTY OF THOMAS BUILT BUSES, INC. ANY REPRODUCTION OR DISTRIBUTION OF THIS MATERIAL OR ANY PART WITHOUT WRITTEN PERMISSION OF THOMAS BUILT BUSES, INC. IS STRICTLY PROHIBITED. COPYRIGHT THOMAS BUILT BUSES, INC.

Model: Saf-T-Liner C2
Quote Number: 398149
Locality: KY

SIDE	ROW	SPACING	WHEEL BASE
LEFT		27.7	26.2
LEFT		31.4	29.9
RIGHT		31.4	29.9

TITLE		PLAN AND ELEVATION BODY 311TS	
DRN-05-25-23	BY: T. Dean	SIZE	DWG. NO.
SCALE 3/8"=12"		S	877328

SEATING CAPACITY: 14 + 2 WC + DRIVER

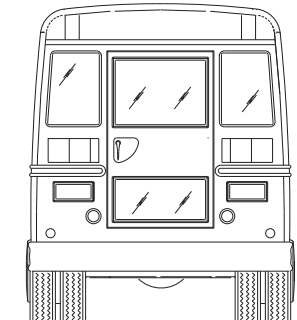
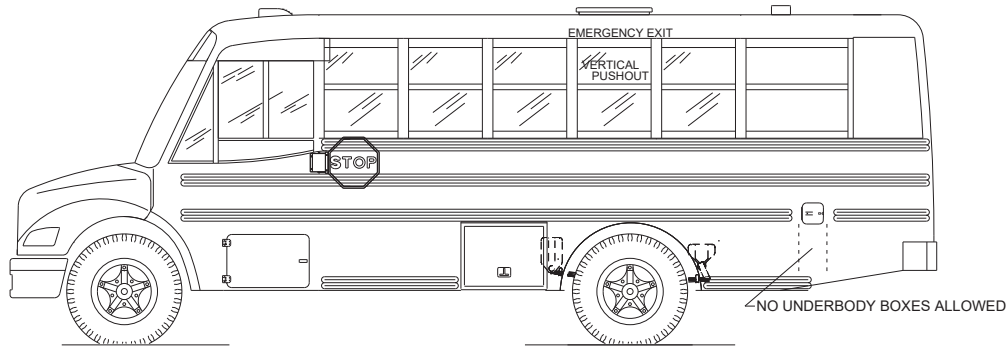

CAUTION - LEFT SIDE BARRIER IS NOT IN STANDARD LOCATION, SEE SEATING PLAN.

CAUTION! - RIGHT SIDE BARRIER IS NOT IN STANDARD LOCATION, SEE SEATING PLAN.

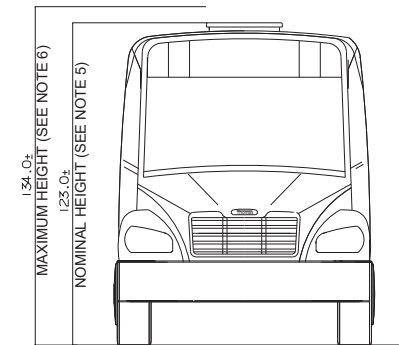
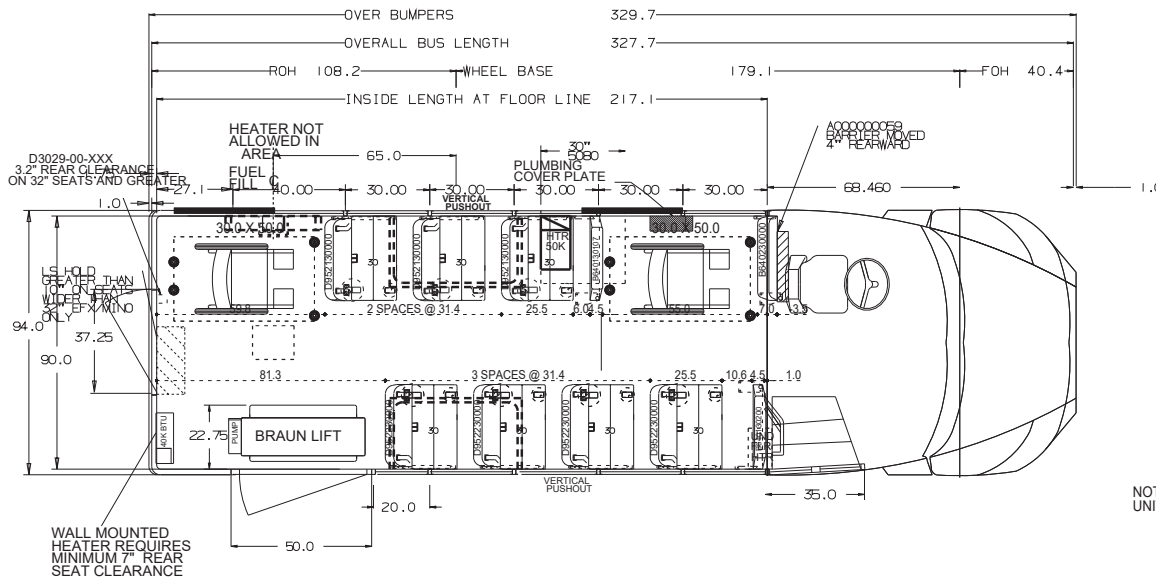

NOTES:
UNIT EQUIPPED WITH OVERHEAD TRACK REINFORCEMENT

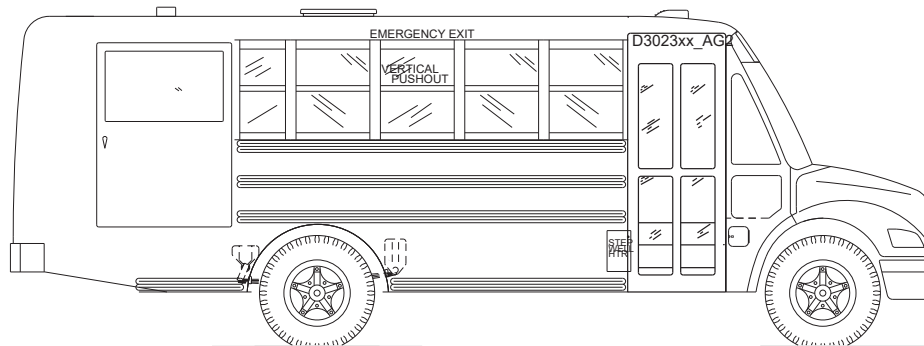

ALL DIMENSIONS ARE FOR REFERENCE ONLY

GENERAL NOTES

- SOME ITEMS, SUCH AS CV MIRRORS, ROOF LUGGAGE RACKS, AND OTHER ITEMS, ARE SHOWN IN ONE VIEW ONLY FOR CLARITY.
- THIS DRAWING IS A REPRESENTATION ONLY AND MAY NOT HAVE ALL ITEMS REQUIRED. PLEASE REFER TO ORDER!
- THE CLEARANCE BETWEEN BOTTOM OF BUS OR BOTTOM OF UNDERBODY COMPARTMENTS AND GROUND WILL VARY ACCORDING TO TIRE SIZE, BUS LOAD, AND SUSPENSION TYPE.
- THE MAXIMUM WIDTH AT BELT LINE OVER GUARD RAILS IS 96".
- THE NOMINAL BUS HEIGHT IS BASED ON A STANDARD BODY AND LARGEST SIZE TIRE.
- THE MAXIMUM BUS HEIGHT IS BASED ON BODY WITH OPTIONS SUCH AS A/C UNITS, STROBE LIGHT, CARGO SUSPENSION ETC.
- OVER BUMPER DIMENSION DOES NOT TAKE INTO ACCOUNT OPTIONS THAT MAY ADD TO THE TOTAL LENGTH OF THE BUS, SUCH AS MIRRORS, LIGHTS AND CROSSING ARMS.

THIS DRAWING AND ALL INFORMATION PROVIDED WITH IT ARE THE PROPERTY OF THOMAS BUILT BUSES, INC. ANY REPRODUCTION OR DISTRIBUTION OF THIS MATERIAL OR ANY PART WITHOUT WRITTEN PERMISSION OF THOMAS BUILT BUSES, INC. IS STRICTLY PROHIBITED. COPYRIGHT THOMAS BUILT BUSES, INC.

Model: Saf-T-Liner C2
Quote Number: 398148
Locality: KY

SIDE	ROW	SPACING	WHEEL RADIUS
LEFT		31.4	29.9
RIGHT		31.4	29.9

TITLE PLAN AND ELEVATION BODY 191TS
DRN: 06-05-23 BY: T. Dean SIZE DWG. NO. 877890
SCALE 3/8"=12" S

THOMAS BUILT BUSES, INC.
HIGH POINT, NC