



RESOURCE GUIDE
for
Alternate Kentucky Summative Assessment
(AKSA)
Attainment Tasks
2023-2024



Table of Contents

Introduction	3
General Information and Procedures.....	3-5
Glossary of General Terms.....	6-11
English Language Arts (Reading and Writing).....	12
Glossary of English Language Arts Terms.....	13-20
Mathematics.....	21
Glossary of Mathematics Terms.....	22-26
Science.....	27
Glossary of Science Terms.....	28-33
Social Studies.....	34
Glossary of Social Studies Terms	35-41

Introduction

In response to feedback from Kentucky stakeholders, the Kentucky Department of Education (KDE) has created the Alternate Kentucky Summative Assessment (A-KSA) Resource Guide. The purpose of this Resource Guide is to provide Kentucky teachers and administrators with a document that contains information related to content instruction and administration of the A-KSA Attainment Tasks. Based on feedback from teachers in the field, great effort has been made to further reduce the language, memory load, and complexity in the Attainment Tasks and still remain aligned to the content standards.

In this document, teachers will find information on how to make adaptations to the Attainment Tasks while remaining compliant with the testing protocol. Additionally, this document provides pictures of general terms (that **may** be used in test administration) for each content area. Teachers may begin using these pictures during instruction to familiarize students with the pictures prior to testing. Finally, for some content areas at specific grade levels, this document provides additional instructional information based on assessment protocols.

General Information

This section of the Resource Guide has two specific purposes. First, this section will discuss some basic testing procedures. When administering the assessment, the test administrator should:

- Carefully read the italicized directions that precede each question. Instructions can change from question to question.
- Emphasize words in the questions that are bolded and underlined (e.g., **not**, **most**, **likely**, **best**, etc.) when reading questions to the students.
- Determine for each student if words provided in parenthesis () should be used in place of, or in addition to, the preceding word.
- Determine if the student would benefit from using the picture response options, having the test only read aloud, or if picture response options need to be adapted.
- Orient the student to the materials. Below are several examples of acceptable student orientation:
 - Prior to reading the question, draw the student's attention to the response options. (e.g., point to and read aloud each response option)
 - Read picture captions to the student while presenting each response option.
 - Direct the student to look at supplemental materials that are needed to answer the question (e.g., graphs, maps, storyboards, sentence templates).
 - When the task calls for completing a sentence template, tell the student in advance (e.g., "I will read an incomplete sentence, and then you will pick the best word/phrase to complete the sentence.").
 - If the question includes a cloze (fill in the blank) sentence, the test administrator may read the sentence with each response option.

- If a student needs pictorial support, present the pictures from the story board (that accompanies the passage) to the student as the passage is read aloud.
 - Each passage includes superscript numbers before sentences or groups of sentences. This superscript number corresponds to a picture on the storyboard. If using pictures, test administrators should present the corresponding picture as the passage is read.
 - Test administrators may cut apart pictures and sequence them by paragraph.
 - Test administrators may point to the pictures as they read aloud to the student.
 - Test administrators may cover and uncover pictures as appropriate.
- Reread any portion of the script, passage, question or response again when it is determined that the student is not focused or engaged in the assessment, as long as it does not direct the student to the correct response.
- Modify and adapt materials as needed to ensure materials are presented to the student in the student’s mode of receptive and expressive communication.

This section will also prepare teachers to make accommodations and adaptations to the Attainment Task itself. The Attainment Tasks are a scripted test, and therefore all materials can be read to the student. However, the student has the option of reading the test for him or herself. Teachers always have the option to present the question to the student and read each answer choice to the student (while pointing to the picture) prior to requesting a student response. As indicated above, it is recommended that the teacher orient the student to all materials prior to asking each question. In order for a student to receive adaptations to the test, the accommodations must be necessary for student participation and indicated on the student’s IEP. The accommodations cannot guide or lead the student to the correct answer. Therefore, any adaptation (e.g., coloring the picture) that is made for one response option for a particular question must be made to all response options in that question. Additionally, even when response options are presented in a different format, they must be presented in the same order as they are presented in the task. Examples of some common accommodations (this is not an exhaustive list; please follow testing protocol to ensure the use of appropriate accommodations):

- Enlarge the tasks – Both questions (if necessary) and pictures may be copied and enlarged to facilitate access for students with low vision.
- Put the questions, sentence templates, pictures, and other needed materials into the student’s receptive mode of communication (e.g., use tactile objects, Writing with Symbols, or other modes of communication to present questions)
- Color the pictures – To provide high contrast, pictures may be colored.
- Highlight sections of text that need to be reread (e.g., when the task indicates to reread Line 7 of a poem if needed, the teacher may highlight Line 7 of the poem to help focus the student’s attention to Line 7).
- Raise lines on graphs, maps and pictures using embosser, glue, or puff paint.
- Explain pictures to the student.

- Use pictures that students have used in instruction if they are different from those provided in the task, ensuring that all response options are changed.
- Provide manipulatives to solve math questions.

Teachers may order specialized materials for students with visual impairments. These materials are provided only when required supplemental materials can be enhanced using tactile graphics. Tactile graphics are embossed on special thermal paper. Tactile graphics of maps, charts, ecosystems and other relevant items are provided. Students should be receiving instruction on how to read tactile graphics throughout the year.

Glossary of General Terms

A picture glossary of general terms that may be used in the Attainment Tasks follows on pages 6-11. Based on teacher feedback across the state, beginning with the 2023-24 attainment task administration, emoji style images will be incorporated into the tasks to represent emotions. There will still be instances of characters showing emotions, but emojis will also be utilized.

General Terms

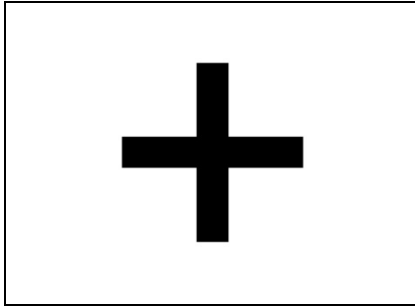

Add, Improve, More, Increase

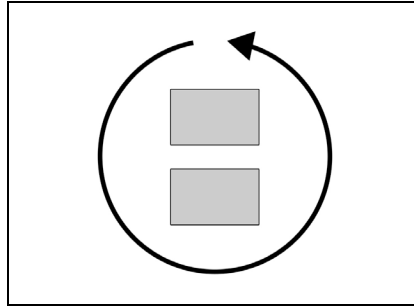

All of the above

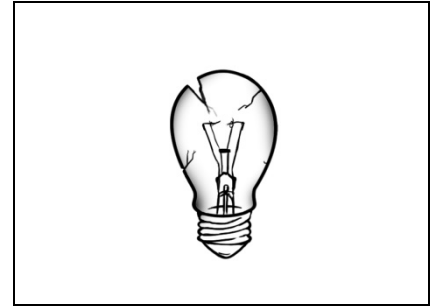

Bad Idea

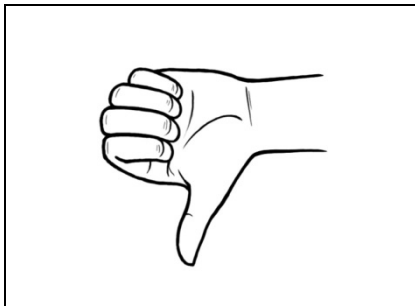

Bad, Harmful, Dislike/Hate,
Negative



Best

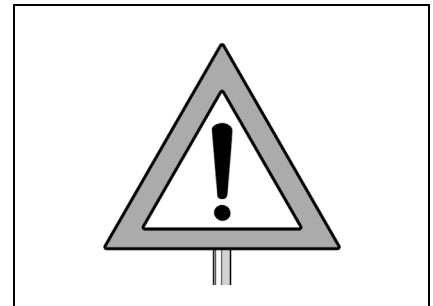

Caution, Concern, Attention,
Danger, Trouble

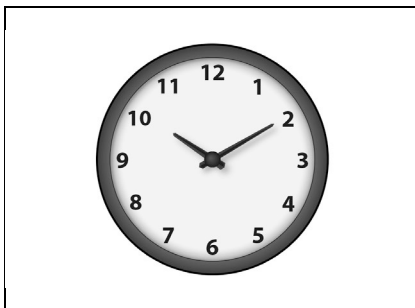

Clock, Time, Hours, Minutes

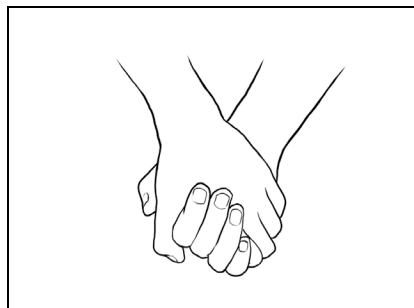

Collaborate, Friendship

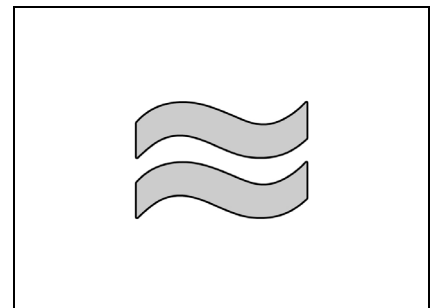

Compare

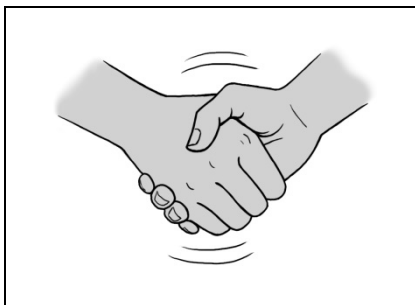

Compromise, Agree, Thank

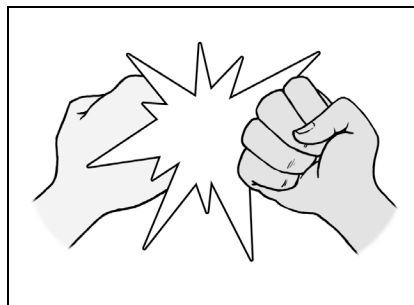

Conflict, Fight

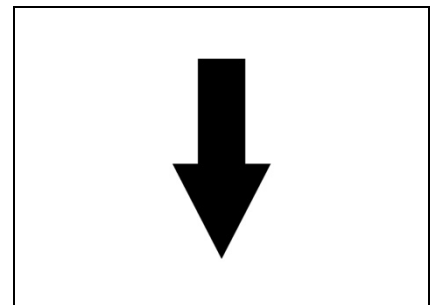

Decrease, Short, Down, Less,
Low, Not enough

Depictions in assessments may vary.

General Terms

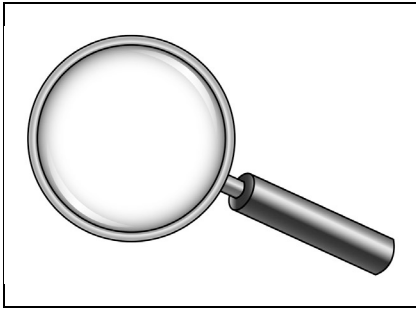

Detail, Find, Investigate

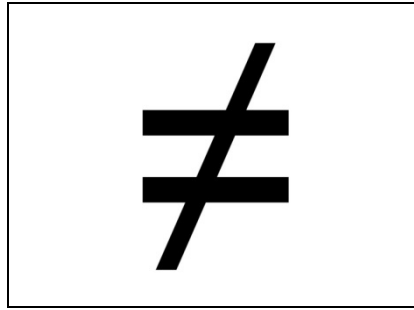

Different, Not equal,
Not the same

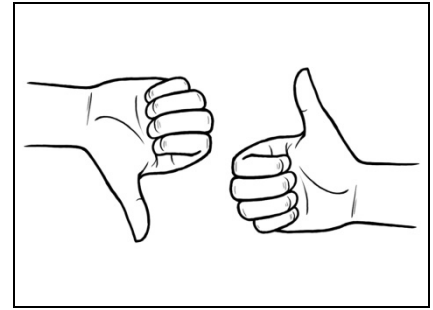

Disagree, Differences

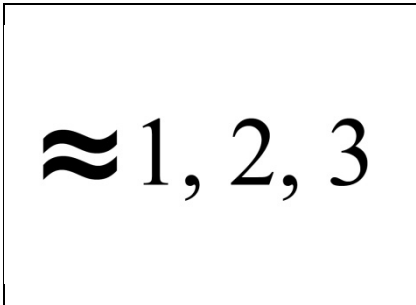

Easy

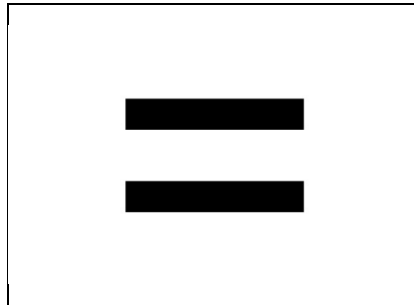

Equal, Neutral, Balance, Same,
No change, Identical, No effect
No impact, No difference, Stable

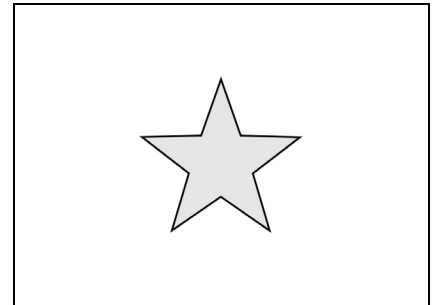

Favorite

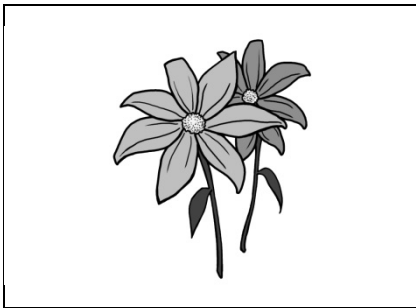

Flowers, Beauty,
Pretty, Vibrant

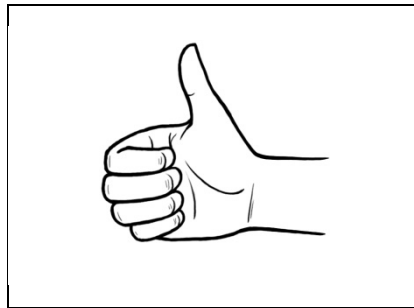

Good, Beneficial, Great, Well,
Positive, Like, Cool

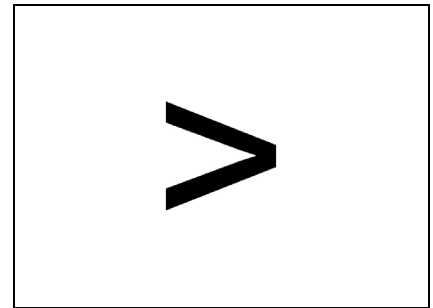

Greater than

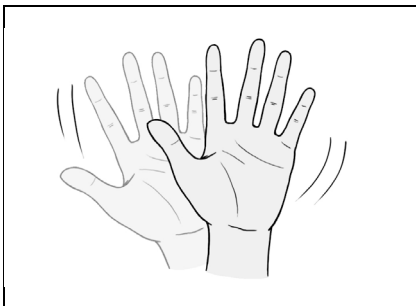

Hello

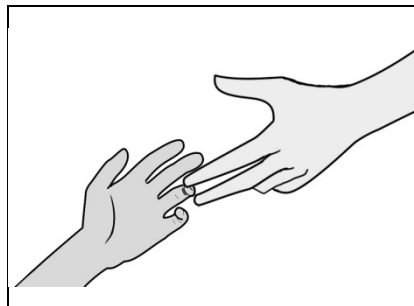

Help, Assist

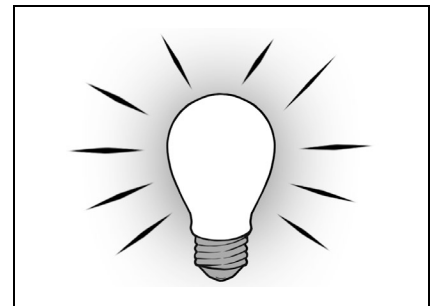

Idea, Main idea

Depictions in assessments may vary.

General Terms

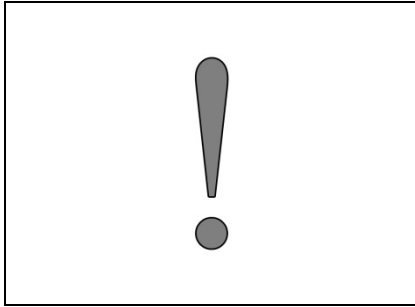

Important, Emphasis,
Excitement

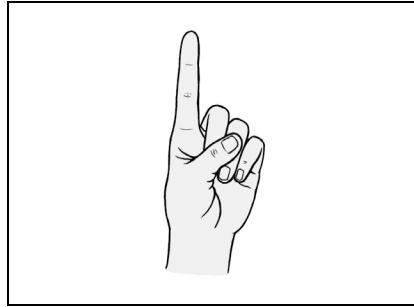

In conclusion, Opinion,
Persuade, Point, One

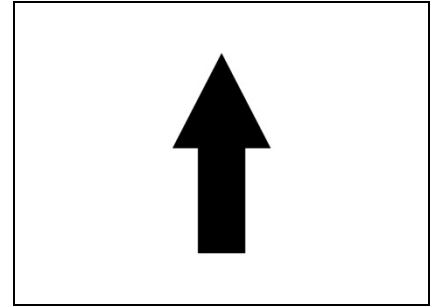

Increase, Long, Up, Tall, More,
Grow, Thrive

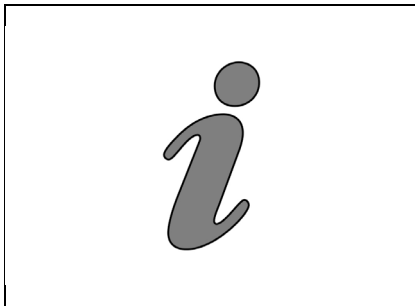

Information, Inform

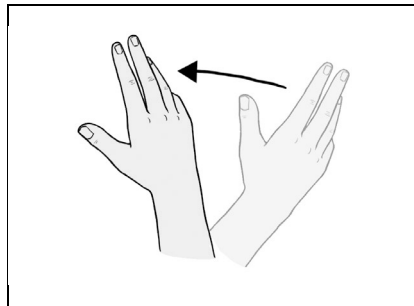

Invite

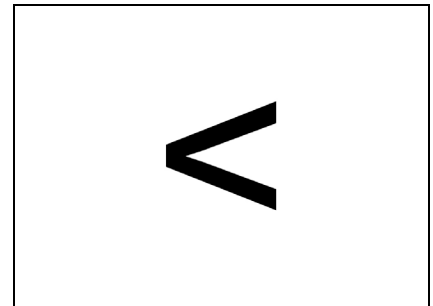

Less than

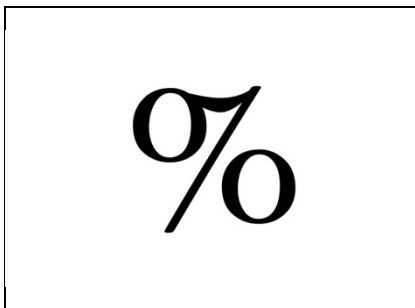

Maybe, Chance, Probability

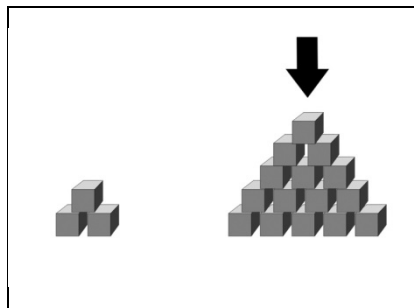

Most

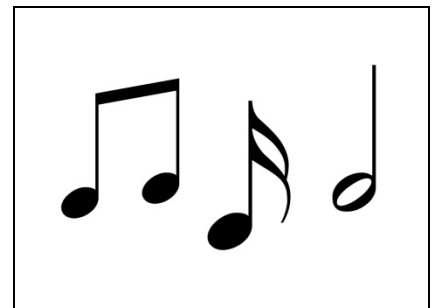

Music

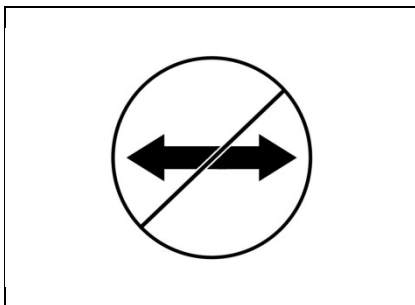

No relationship

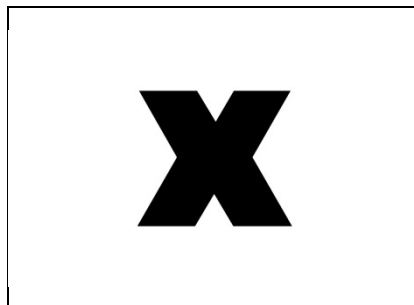

No, Stop, Bad

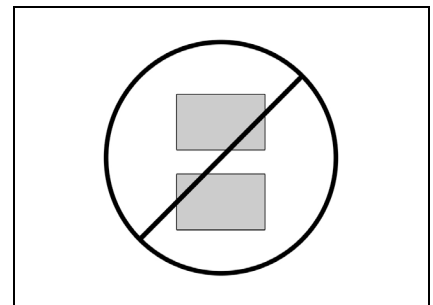

None of the above

Depictions in assessments may vary.

General Terms



Not enough information



Online, Online source

- 1)...
- a.
- b.
- c.
- 2)...
- a.
- b.
- c.
- 3)...
- a.
- b.
- c.

Organize, Outline, Discussion points (may have text)

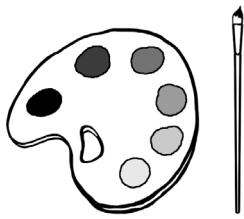

Paint, Creative, Art



Popular



Population



Pretend, Imagine



Purpose, Question, Ask, What



Recess, Playground

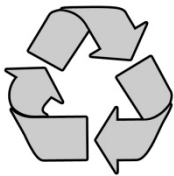

Recycle

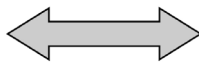

Relationship

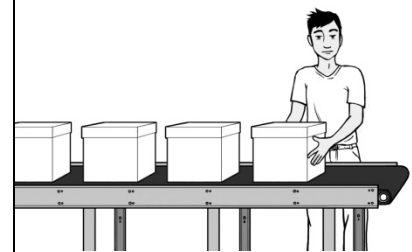

Repetition

Depictions in assessments may vary.

General Terms

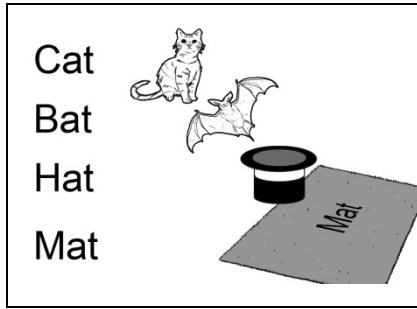

Rhyme

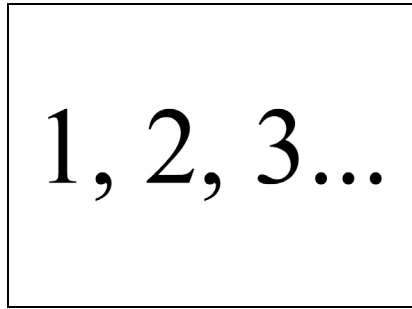

Sequence

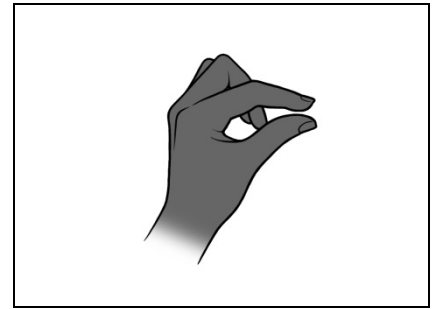

Somewhat, A little

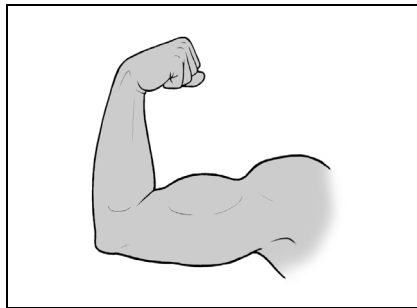

Strong

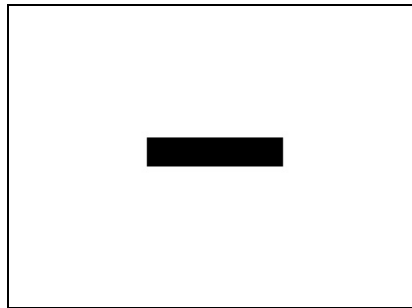

Subtract, Less, Decrease

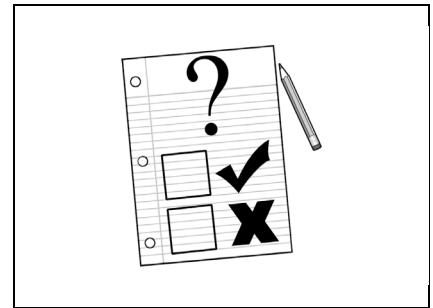

Survey

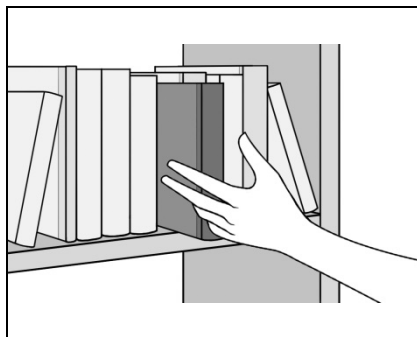

Topic

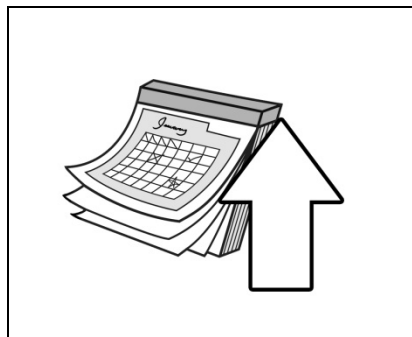

Update

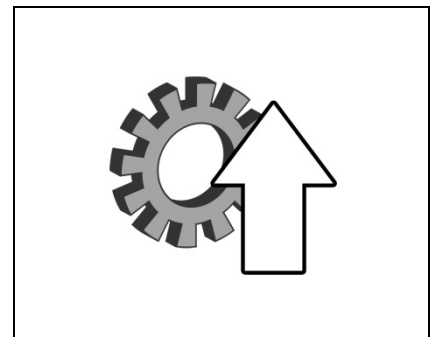

Upgrade (technology advance)

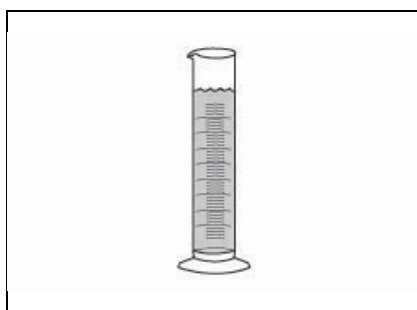

Volume

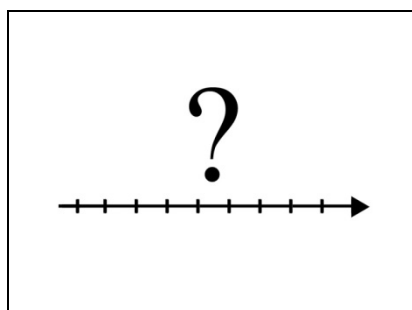

When

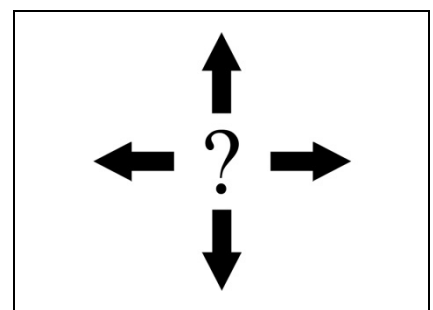

Where

Depictions in assessments may vary.

General Terms

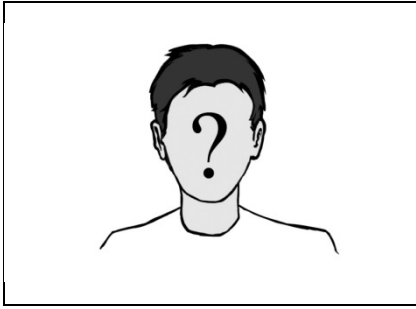

Who

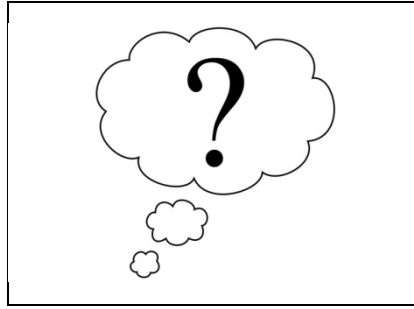

Why

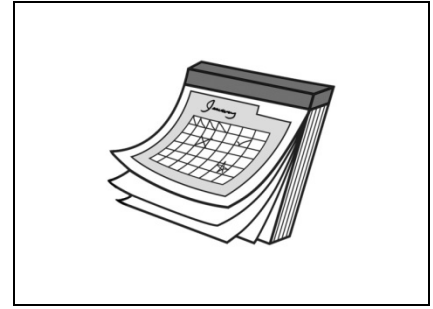

Year, Date, Time

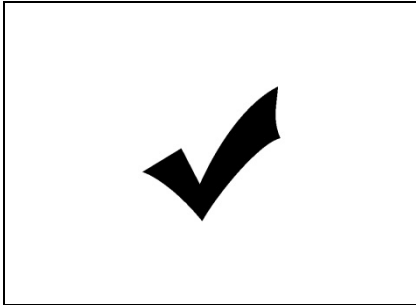

Yes, Solution, True, Credible,
Resolution, Agree

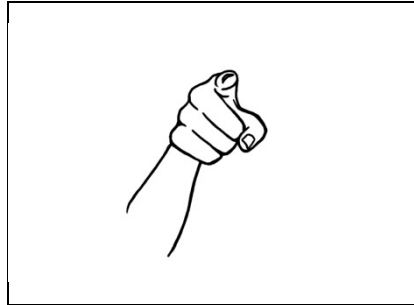

You

Depictions in assessments may vary.

English Language Arts (Reading and Writing)

READING

In reading, the passages were specifically written for the A-KSA and will not be present until materials are delivered to the district. **Instruction should focus on the concepts rather than discrete skills.** For example, students should be learning how to identify a character, setting and plot from a story, not just to identify a specific character from a particular story.

In reading, some tasks require video or audio clips as part of the assessment. When audio or video clips are needed, they will be provided for specific grades. Once a test administrator who has students in those grades has completed the AT Training and corresponding quiz, a link will appear in the OTS called “My Reading Audio and Video Files.” The audio and video clips will be accessible directly on a computer, tablet, or interactive white board with internet connectivity via this link; **DO NOT DOWNLOAD** these clips as they are secure test materials. Additionally, a thumb drive will be included in the testing materials provided during shipping. **At the end of each testing window, the thumb drive (USB drive) must be returned to the District Assessment Coordinator (DAC) for return to the Kentucky Department of Education.** Each animation clip will be narrated and have closed captioning. Additionally, a script will be provided for teachers to reread sections as needed. If needed, it is necessary to read the script exactly as written. There will be a script provided for the audio clip for students who have hearing impairments.

WRITING

In writing, only grades 5, 8 and 11 will be administered. Writing tasks are written in the same format as other content areas of the AT, using multiple-choice questions. Examples of some questions may include asking students to complete a cloze sentence, identifying the purpose or audience, or selecting the word that would be the best transition, closing, introduction, or sensory word. The test administrator will record the student’s response for each item. Students should be familiar with how to use graphic organizers.

For the purposes of this assessment, editing mechanics will be assessed in window one and window two will focus on composition.

The use of technology is included in the writing standards. Ensure students are familiar with accessing the Internet, using computer programs such as word processing applications and PowerPoint and know the purpose of other technologies such as cell phones.

Glossary of ELA Terms

A picture glossary of ELA terms that may be used in the Attainment Tasks follows on pages 13-20.

English Language Arts

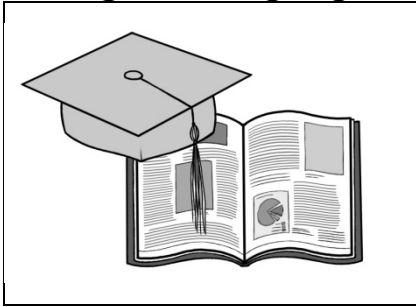

Academic / Scholarly journal

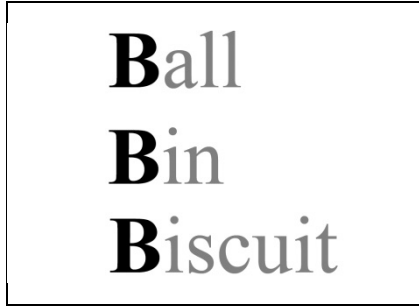

Alliteration

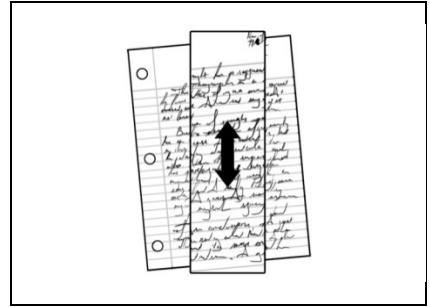

Anywhere

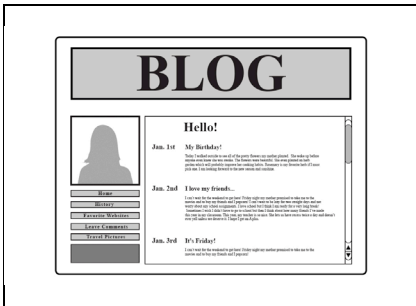

Blog (may be on screen)

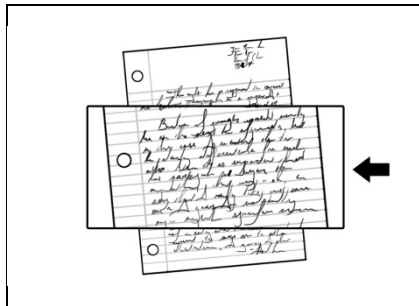

Body (of a paper)



Book, Fact, Novel, Educational, Learned, Reading

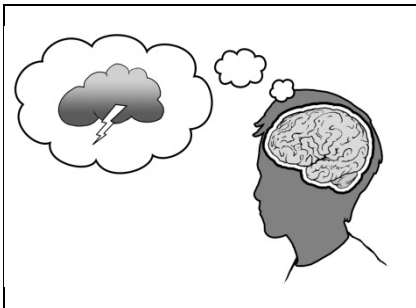

Brainstorm

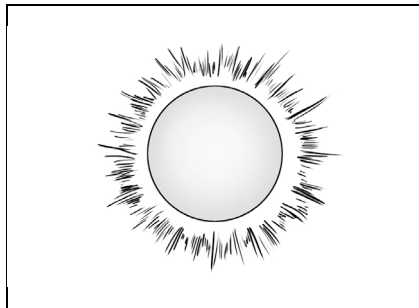

Bright, Summer, Day

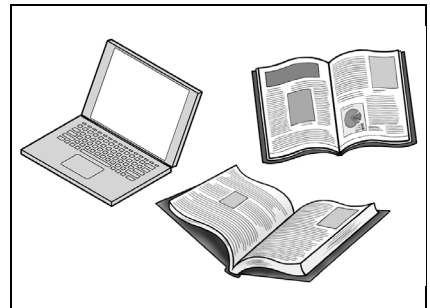

Broaden inquiry, Research, Find out about

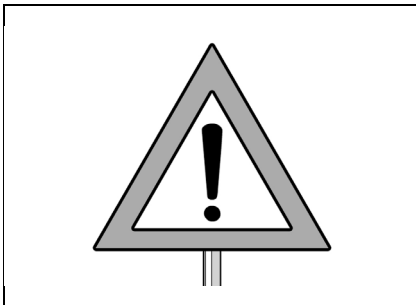

Caution, Concern, Attention
Dangerous, Trouble

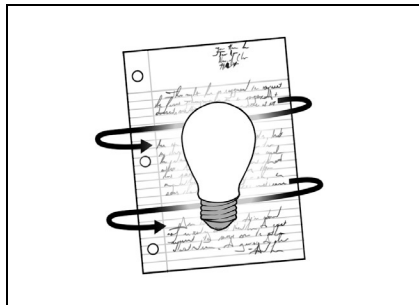

Central idea

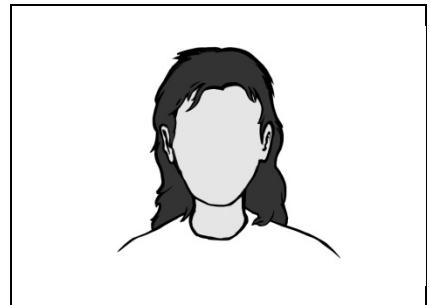

Character

Depictions in assessments may vary.

English Language Arts

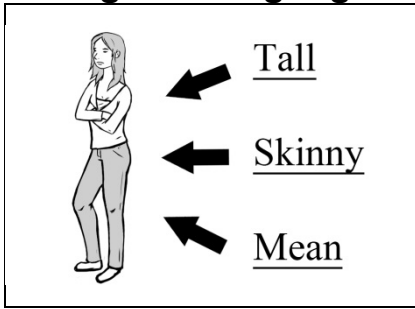

Characterization

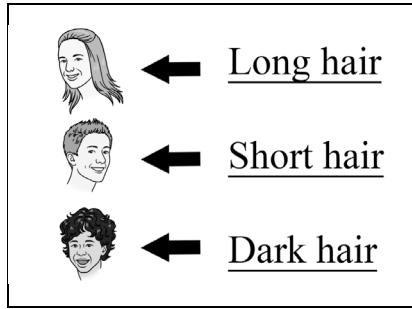

Characters, Characteristics
(describing different)

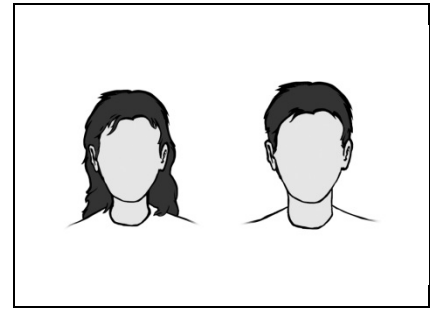

Characters

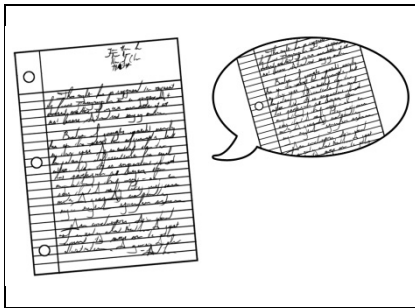

Cite

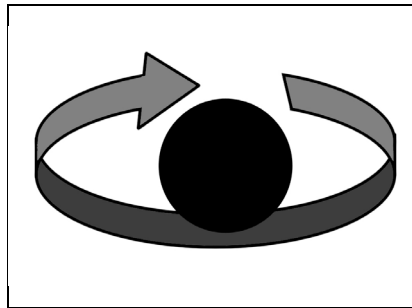

Climax (turning point)

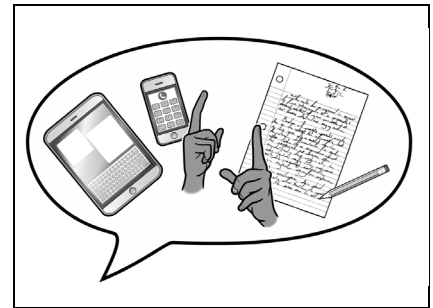

Communicate

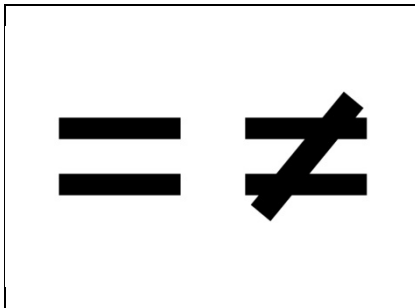

Compare and contrast

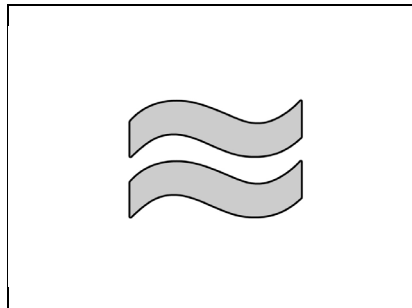

Comparison

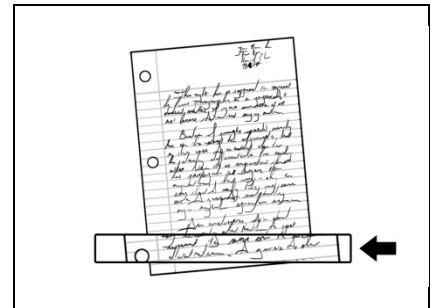

Concluding sentence,
End (of the paper)

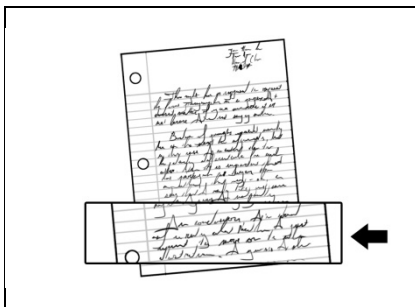

Conclusion

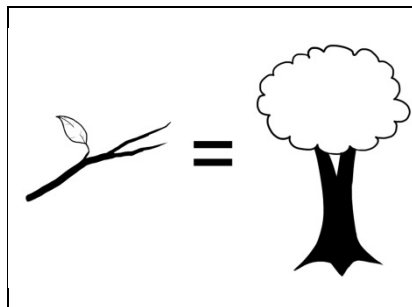

Connotative language

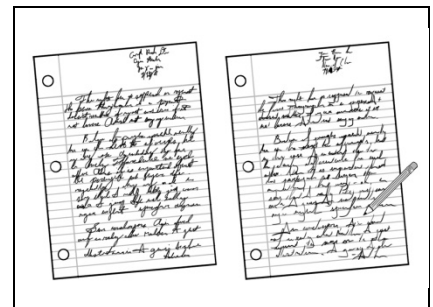

Copy, Plagiarize

Depictions in assessments may vary.

English Language Arts

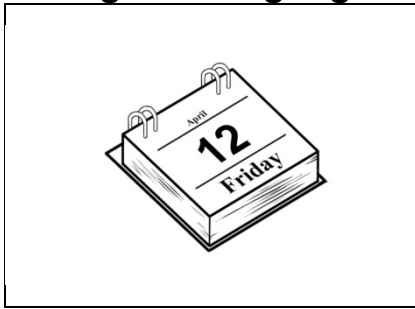

Day



Deeper perspective

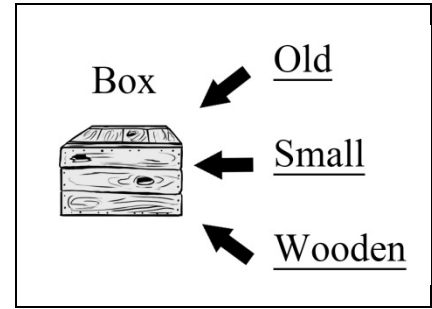

Descriptive, Description,
Descriptive detail

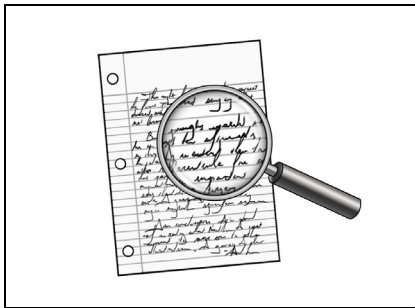

Detail, Supporting details,

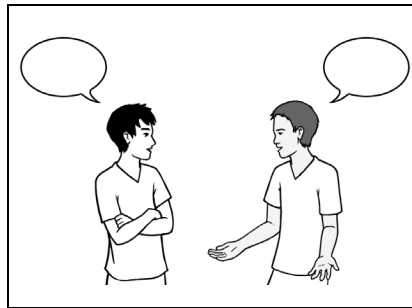

Dialogue

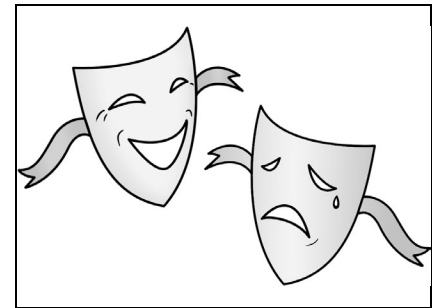

Drama, Comedy / Tragedy

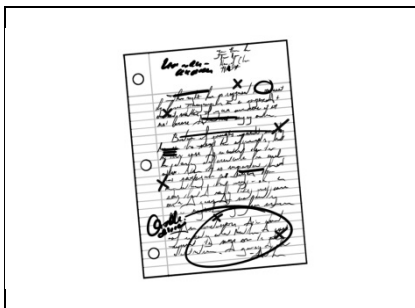

Edit, Make suggestions for
improvement, Correct errors

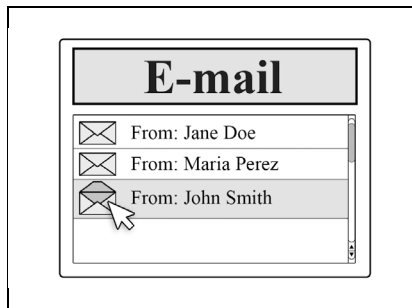

Email
(may be on screen)

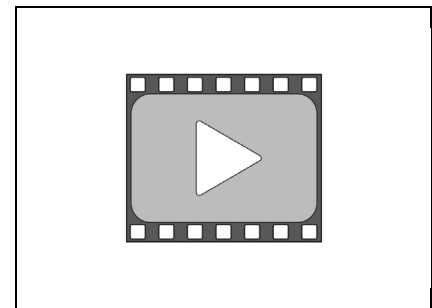

Entertain, Video, Movie

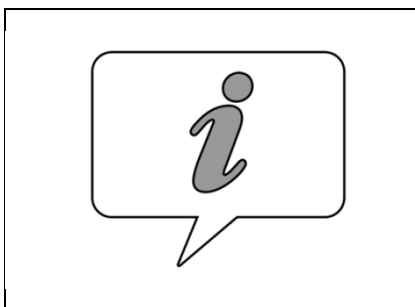

Expository

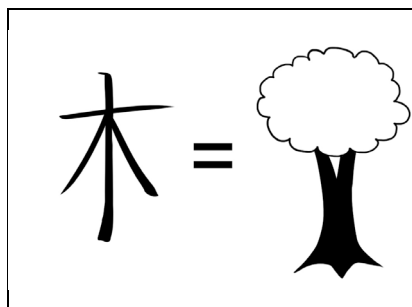

Foreign language

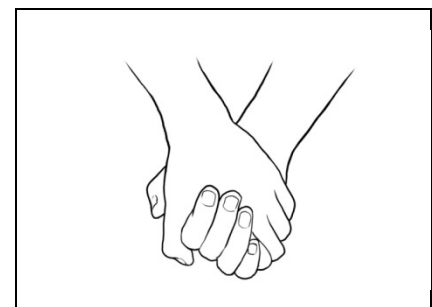

Friend

Depictions in assessments may vary.

English Language Arts

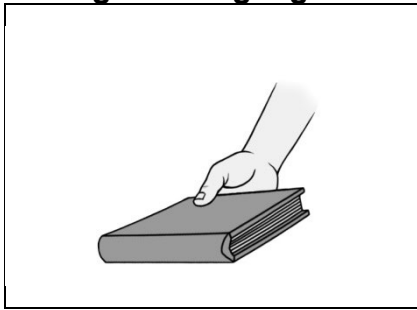

Gather information, Find source

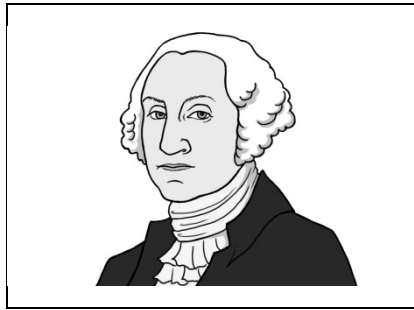

George Washington, History

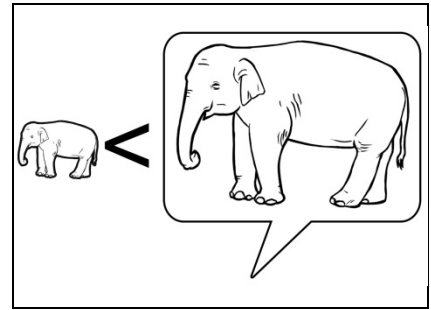

Hyperbole

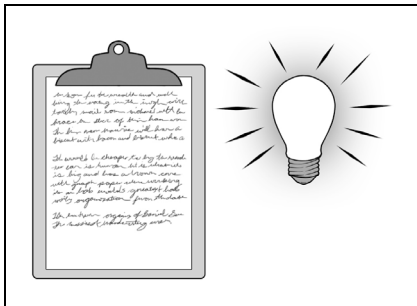

Hypothesis

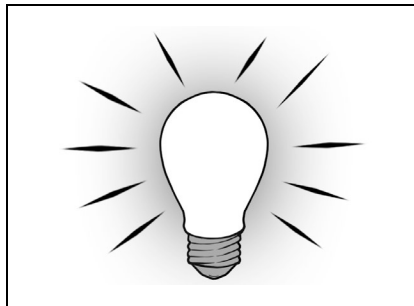

Idea, Main idea

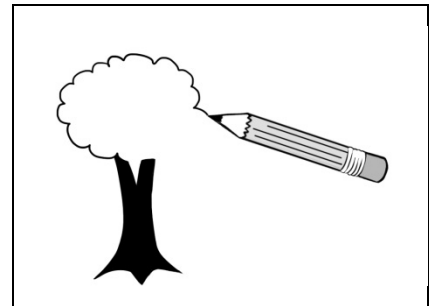

Illustrate, Draw, Make a picture (may be on or off paper)

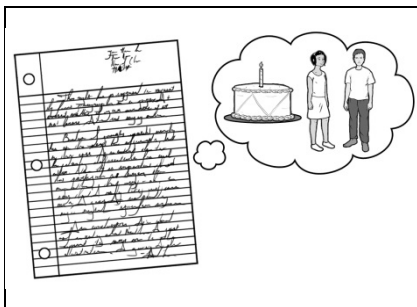

Imagery

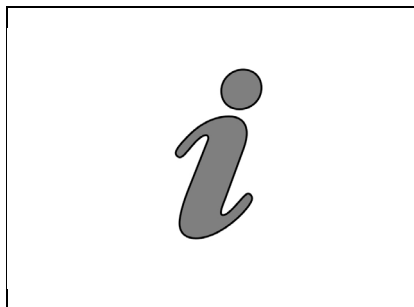

Inform, Information

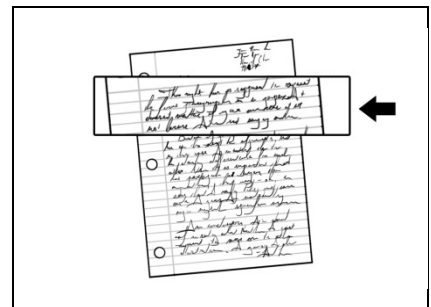

Introduction, Introduce, Beginning

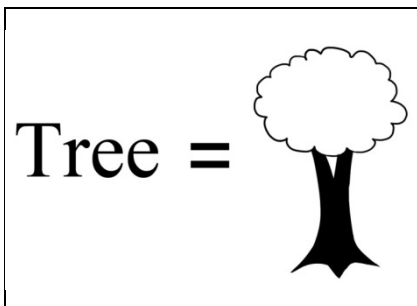

Literal text, Explicit language

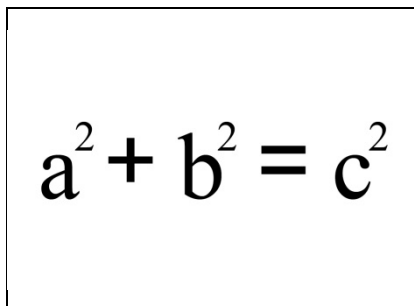

Logic

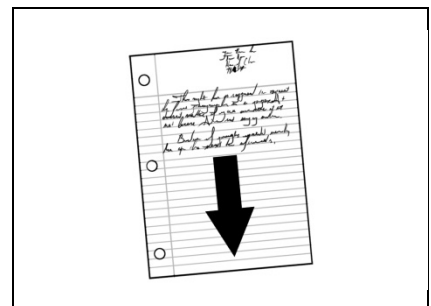

Make project or story longer, length, Use as many words as

Depictions in assessments may vary.

English Language Arts

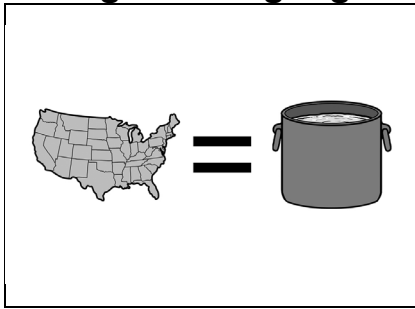

Metaphor
(America is a melting pot)

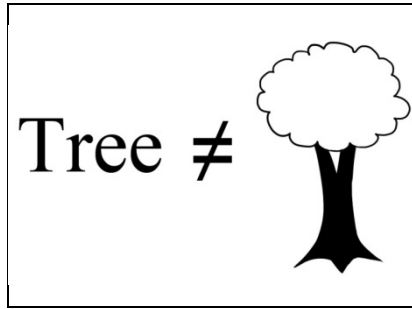

Non-literal text, Figurative



Not enough information

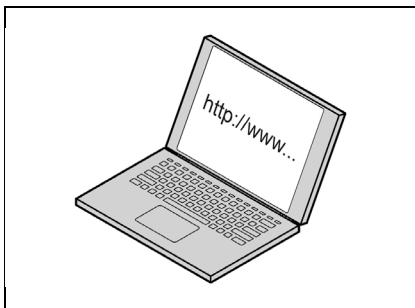

Online, Online source (may be on or off computer screen)

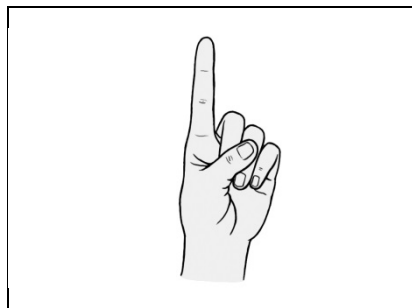

Opinion, One, Persuade

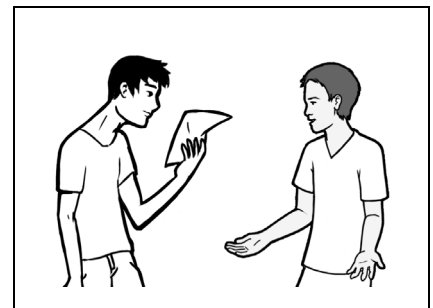

Peer review

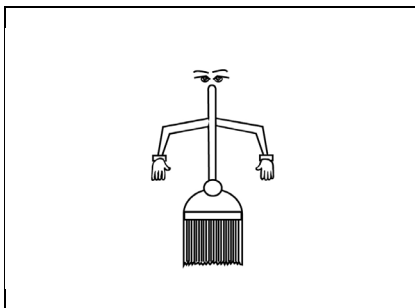

Personification

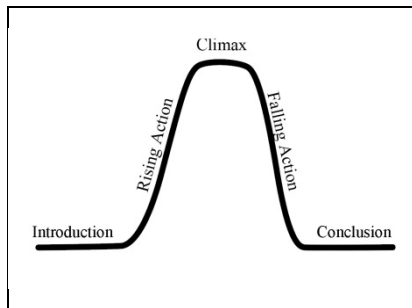

Plot, Narrative

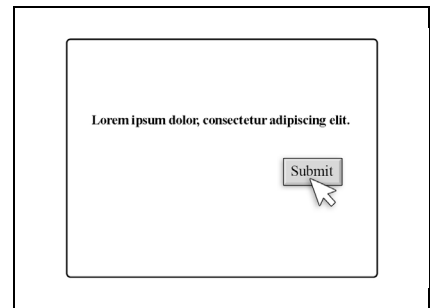

Post a comment
(may be on screen)

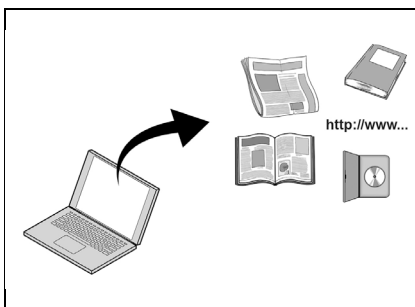

Publish



Purpose for writing, Author's purpose



Purpose, Question, Ask, What

Depictions in assessments may vary.

English Language Arts

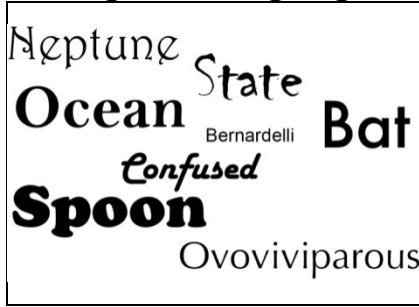

Random words, Different fonts

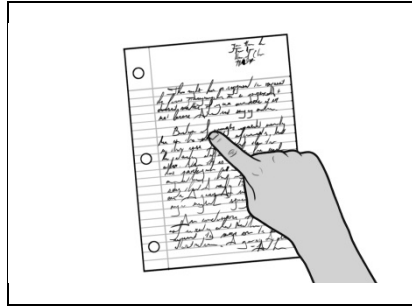

Read the paper, Find or Check errors

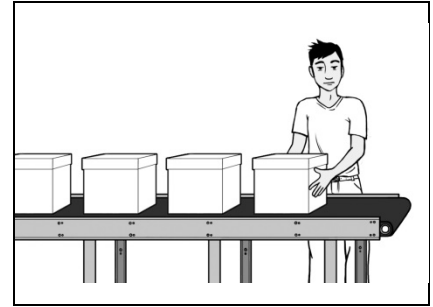

Repetition

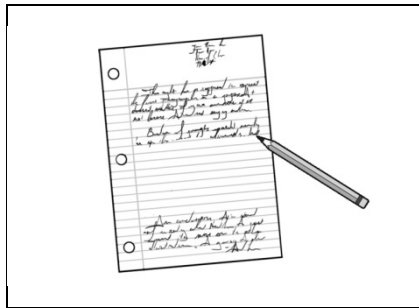

Rewrite body

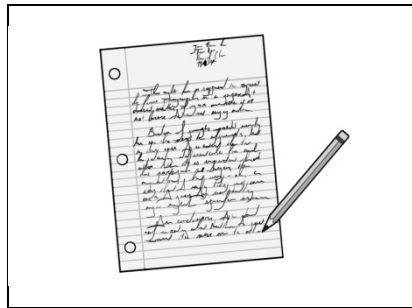

Rewrite conclusion

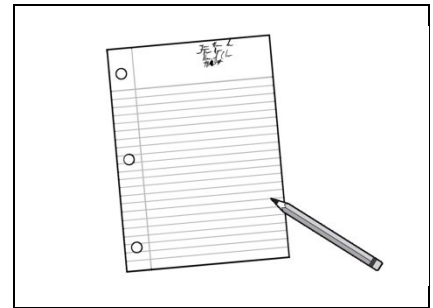

Rewrite entire paper

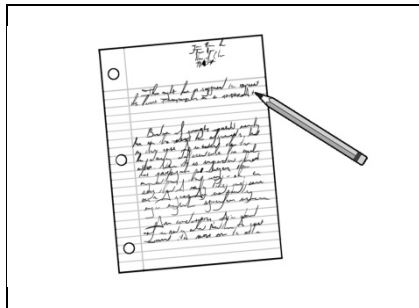

Rewrite introduction

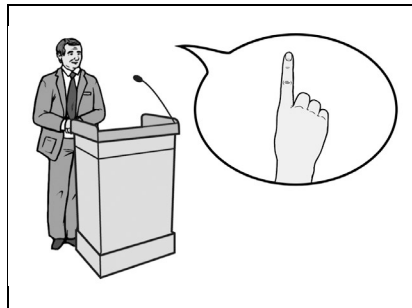

Rhetoric

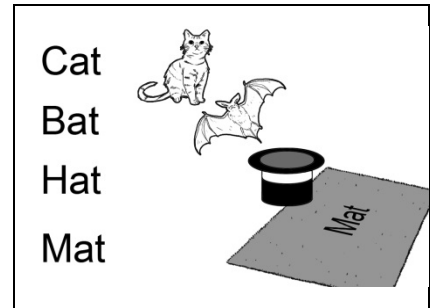

Rhyme

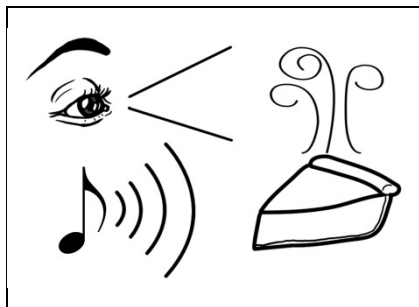

Sensory language

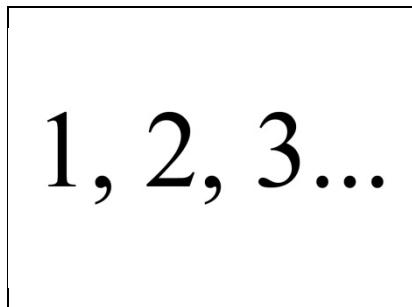

Sequence, Order, Word count

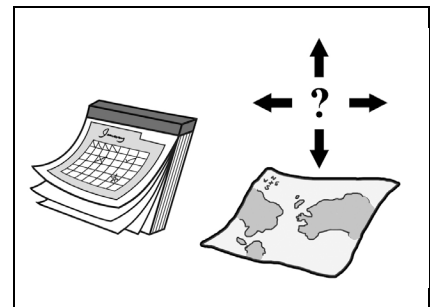

Setting

Depictions in assessments may vary.

English Language Arts

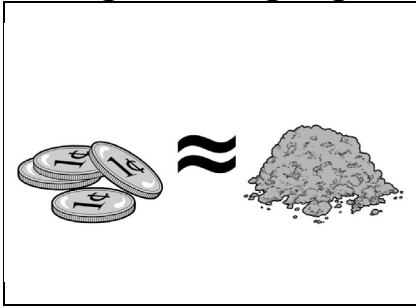

Simile
(cheap as dirt)

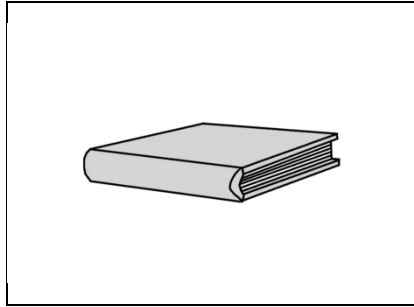

Source, Resource (one)

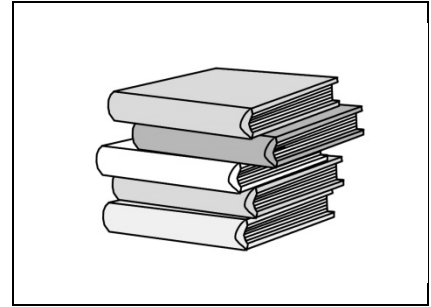

Sources, Resources

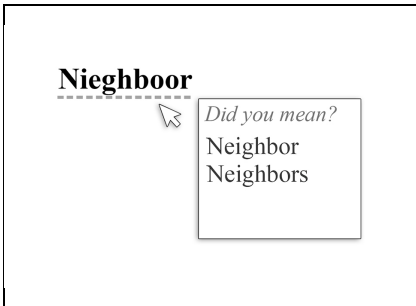

Spell check
(may be on or off-screen)

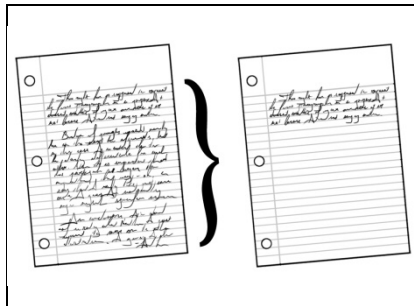

Summary

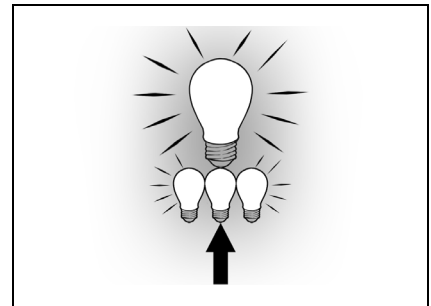

Supporting idea

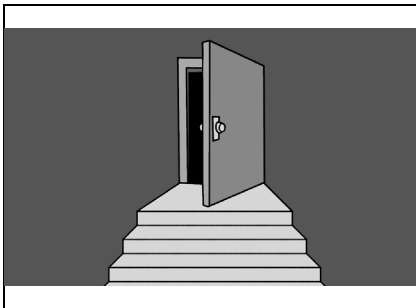

Suspense

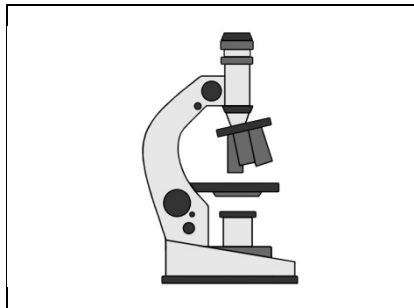

Technical language

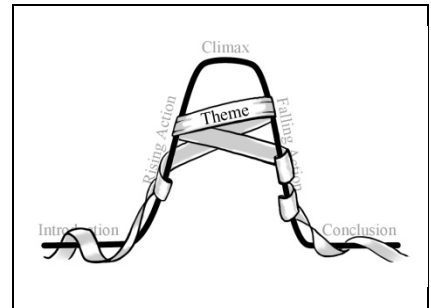

Theme

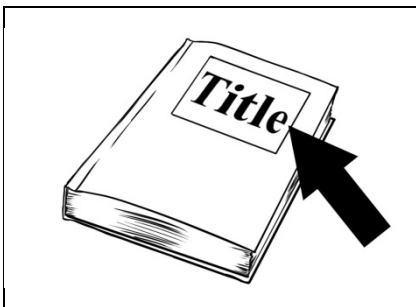

Title of book

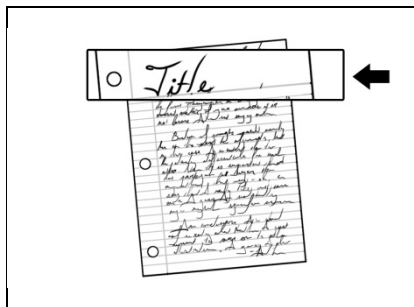

Title of paper

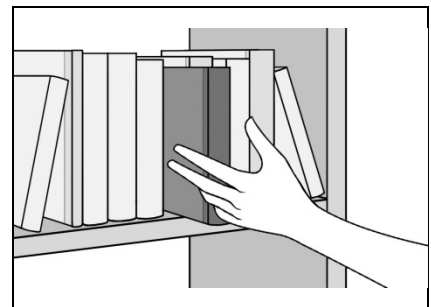

Topic

Depictions in assessments may vary.

English Language Arts

First Besides While
Then
Truly
However
Therefore Next

Transition words

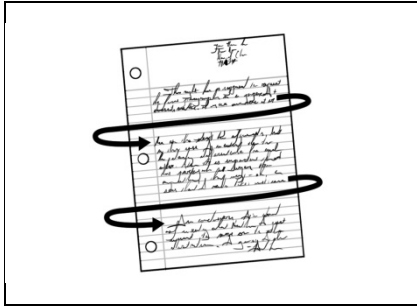

Transitional sentence, Create flow

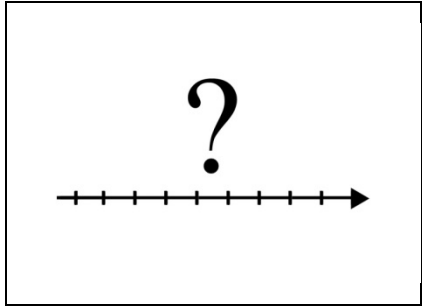

When

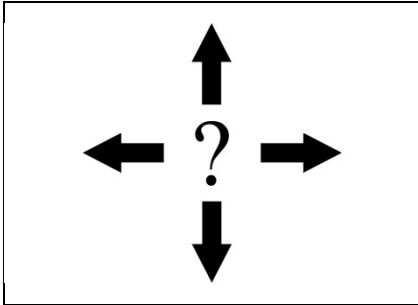

Where

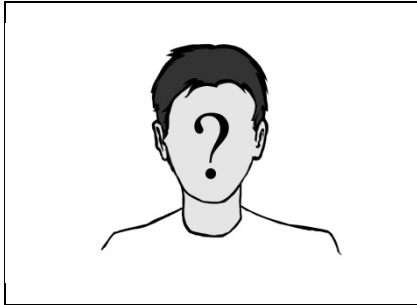

Who



Why

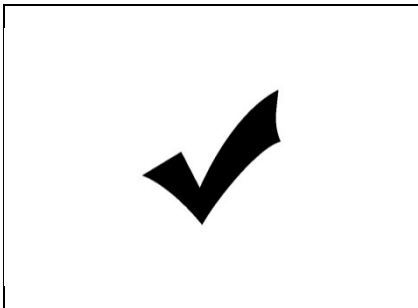

Yes, Solution, True, Credible, Resolution, Agree

Depictions in assessments may vary.

MATHEMATICS

In mathematics, the incorporation of the eight mathematical practices is essential to student learning. Instruction should focus on understanding concepts and the ability to apply mathematics.

In mathematics, **illustrations are used to express numbers at the elementary school level only**. Because pictures of apples, dollars, rulers and/or thermometers are not always easy to read when large numbers are involved, the Attainment Tasks will use consistent representations across all content, regardless of the unit being measured. Below is a list of these representations:

- **Whole numbers** (when standing alone) are illustrated using base ten blocks, hundred squares, and thousand cubes (see glossary below for examples).
- **Fractions** are illustrated using a circle or pie chart. The numerator is the shaded section of the whole. When the response is a mixed number (e.g., one and one half), the whole numbers in that item will also be represented with a whole, shaded circle. The whole numbers used in this section are small enough to make this possible (see glossary below for examples).
- **Decimals (including money)** will always be represented by the number (as described above with base ten blocks), a decimal point, and the hundred squares with the corresponding decimal portion shaded (see glossary below for examples).
- **Negative integers** are represented by base ten blocks that are completely shaded.

Middle school and high school mathematics tasks will **not** have illustrations for numbers, but teachers can still use manipulatives and pictures if the student needs these materials. Remember, adaptations and accommodations just need to be consistent across the response options of each question.

Glossary of Mathematics Terms

A picture glossary of Mathematics terms that may be used in the Attainment Tasks follows on pages 22-26.

Math

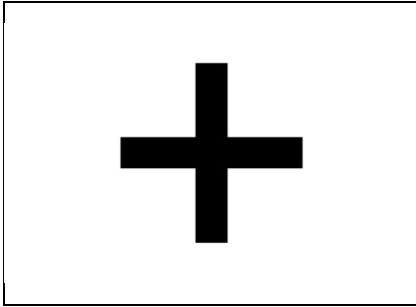

Add, Improve, More, Increase

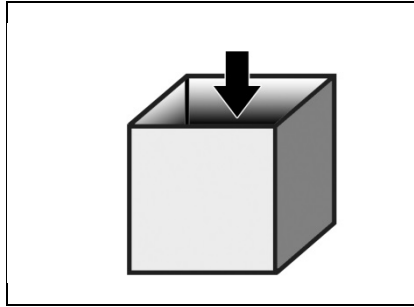

Amount of space in a closed figure

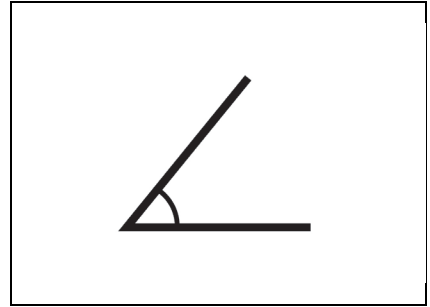

Angle, Acute angle

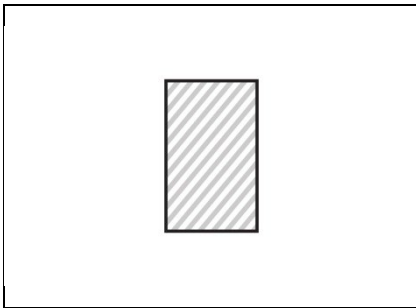

Area

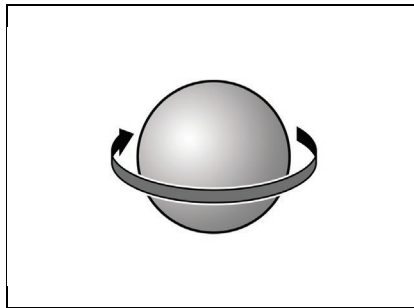

Circumference

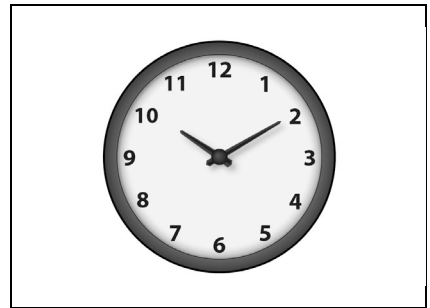

Clock, Time, Hours, Minutes

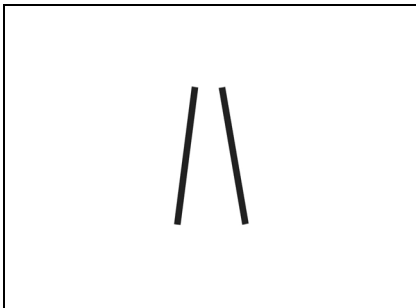

Congruent (sides)

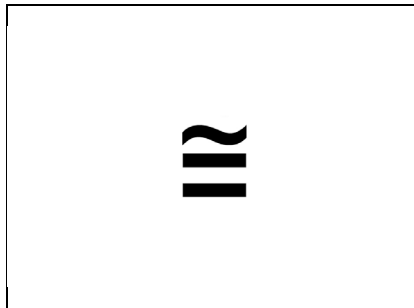

Congruent (symbol)

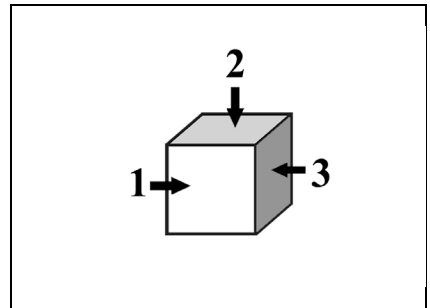

Count cube faces

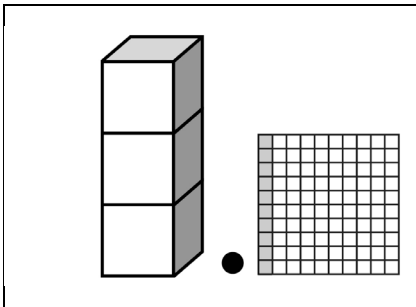

Decimals (e.g. "3.1")
ELEMENTARY ONLY

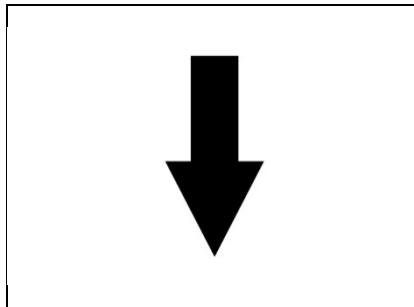

Decrease, Down, Less

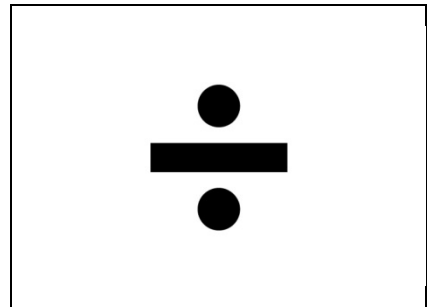

Division

Depictions in assessments may vary.

Math

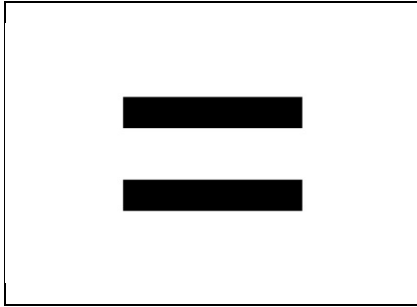

Equals, Does not change,

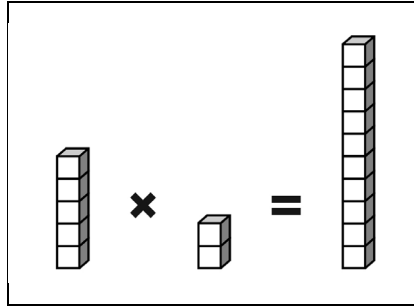

Equation (e.g., "5×2=10")
ELEMENTARY ONLY

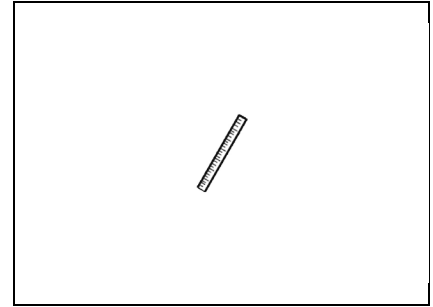

Foot

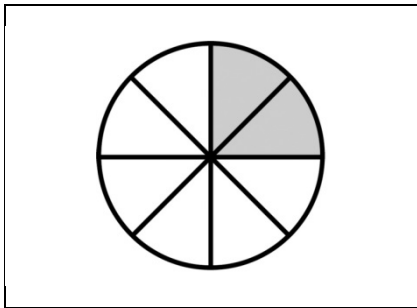

Fraction (e.g., " $\frac{2}{8}$ ")
ELEMENTARY ONLY

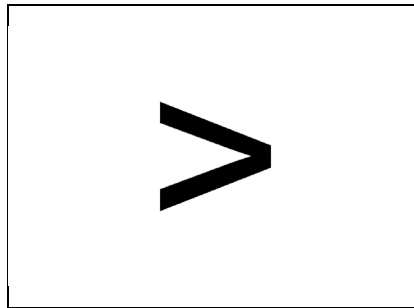

Greater than

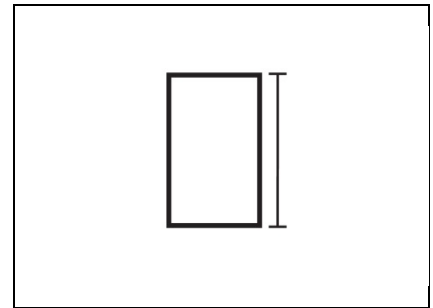

Height, Length

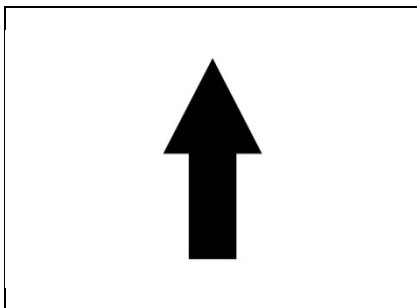

Increase, Up, More

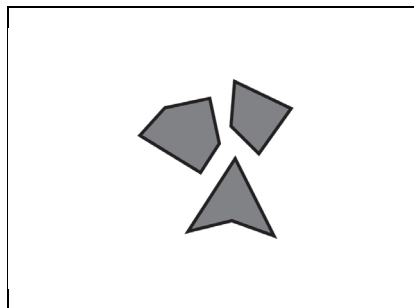

Irregular shapes, Irregular

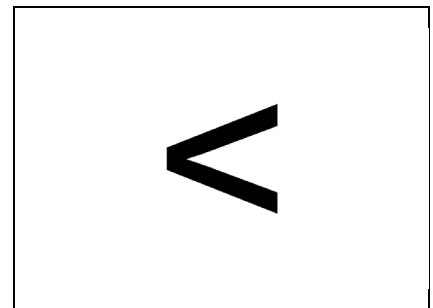

Less than

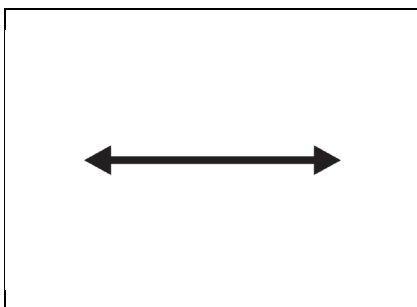

Line

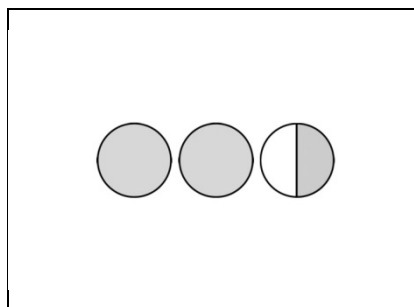

Mixed number (e.g., " $2\frac{1}{2}$ ")
ELEMENTARY ONLY

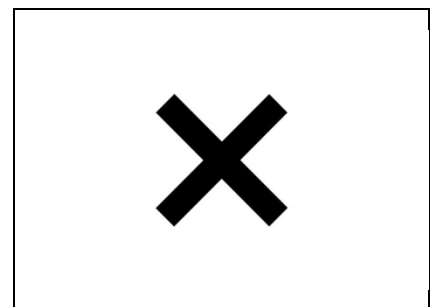

Multiplication

Depictions in assessments may vary.

Math

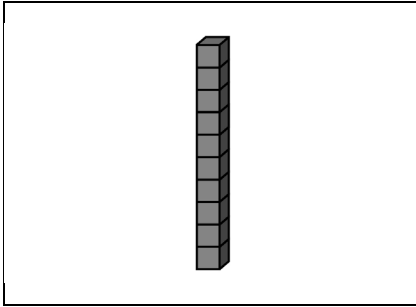

Negative numbers (e.g., “-10”)
ELEMENTARY ONLY

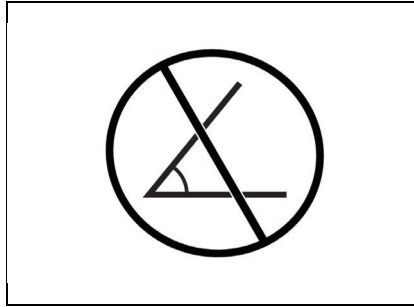

No angle

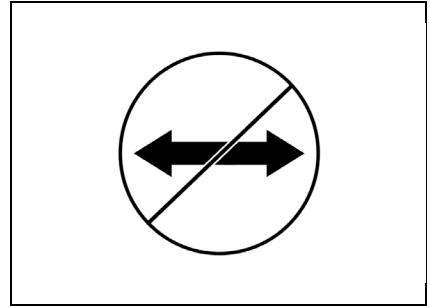

No relationship

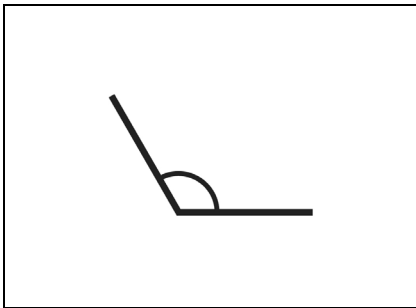

Obtuse angle

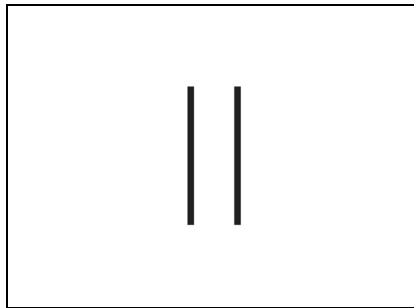

Parallel

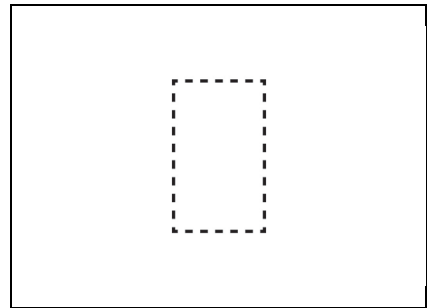

Perimeter

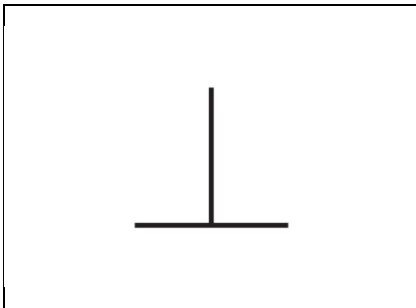

Perpendicular

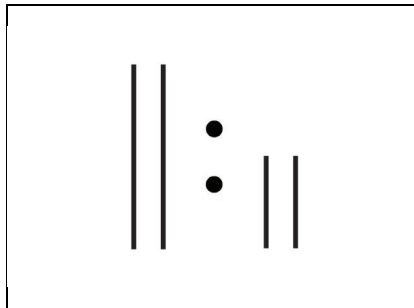

Proportional sides

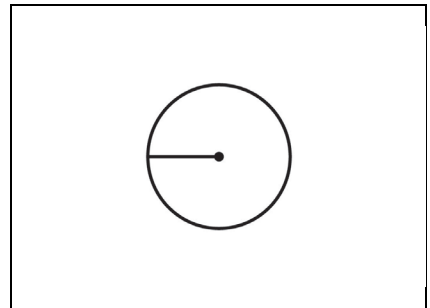

Radius

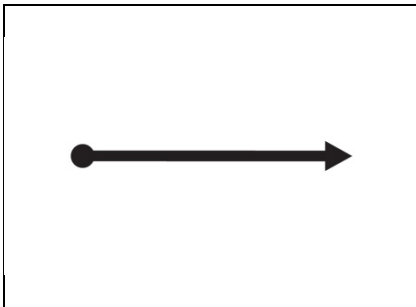

Ray

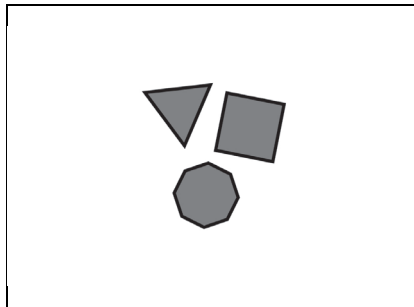

Regular shapes, Regular

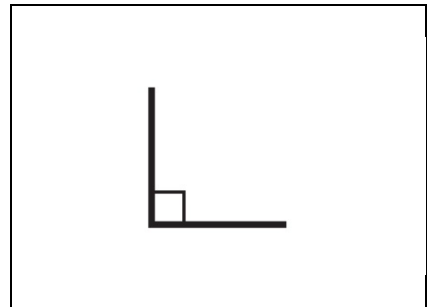

Right angle, 90° angle

Depictions in assessments may vary.

Math

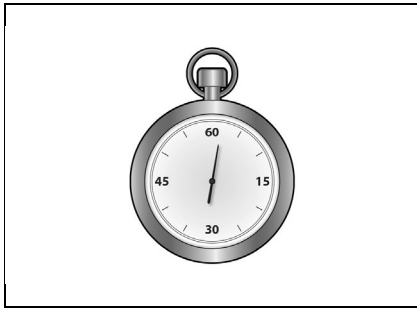

Seconds

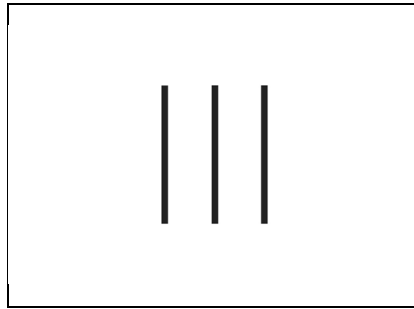

Sides
(e.g., "3 of equal length")

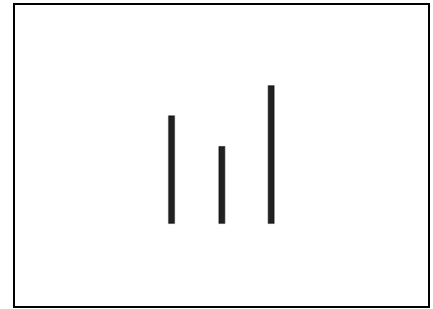

Sides
(e.g., "3")

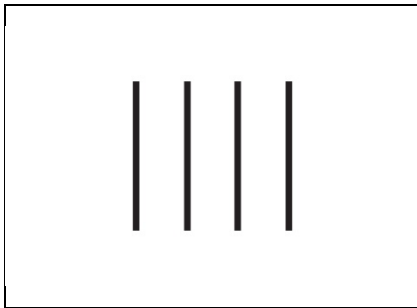

Sides
(e.g., "4 of equal length")

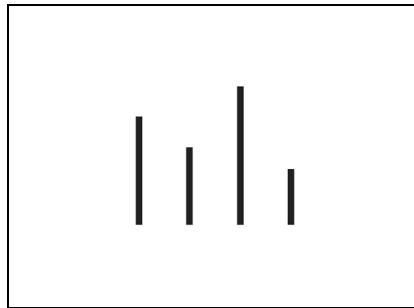

Sides
(e.g., "4")

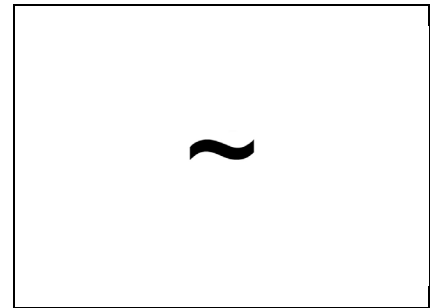

Similar, Approximate

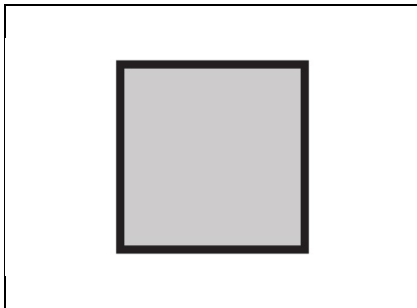

Square
(shape example)

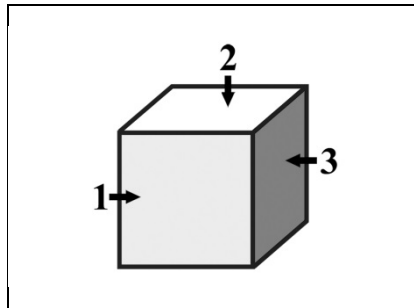

Square units on a surface

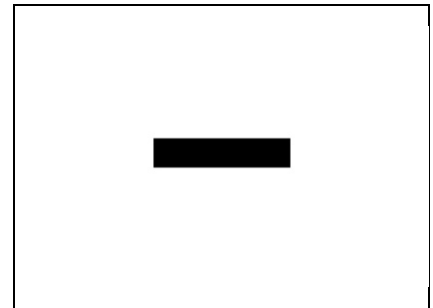

Subtract, Less

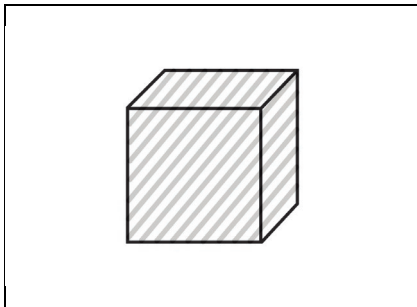

Surface area

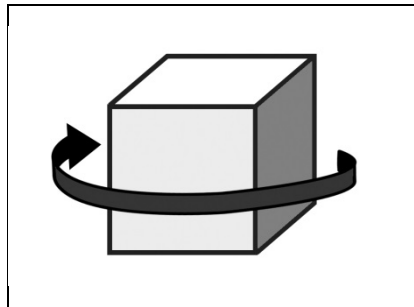

The distance around an object

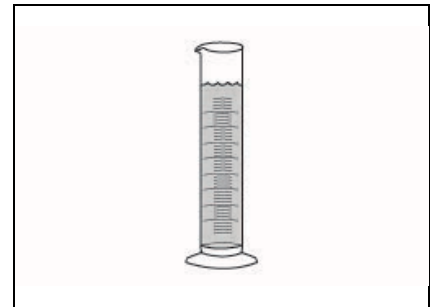

Volume

Depictions in assessments may vary.

Math

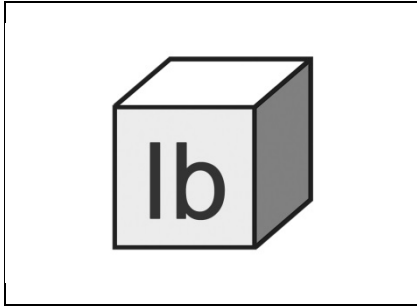

Weight

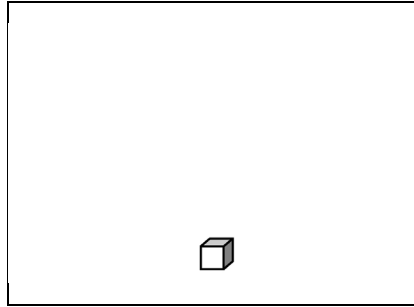

Whole number (e.g., "1")
ELEMENTARY ONLY

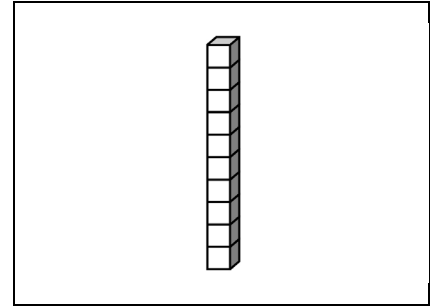

Whole number (e.g., "10")
ELEMENTARY ONLY

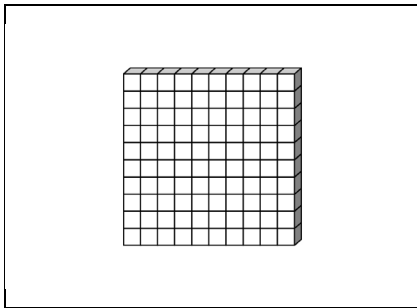

Whole number (e.g., "100")
ELEMENTARY ONLY

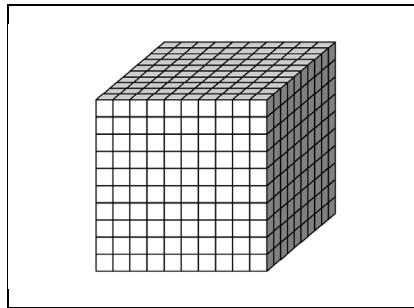

Whole number (e.g., "1000")
ELEMENTARY ONLY

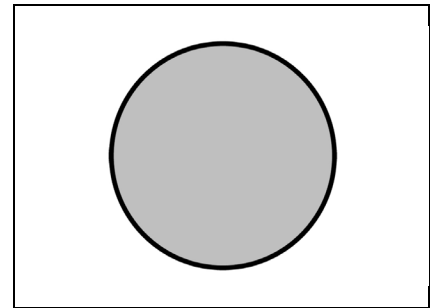

Whole number with fractions (e.g., "1")
ELEMENTARY ONLY

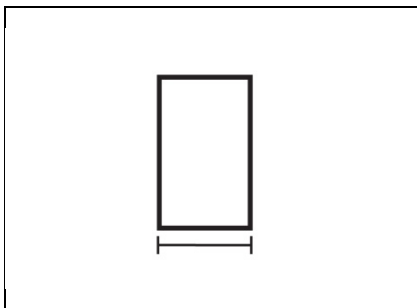

Width

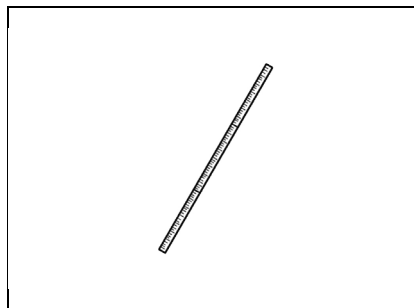

Yard

Depictions in assessments may vary.

SCIENCE

In science, the focus of the assessment is on the application of skills or knowledge across scientific concepts. Students will be asked to answer five multiple-choice questions per standard at each grade level. Students may be asked to use information, data, or evidence to:

- Support a claim
- Make predictions
- Compare models
- Evaluate or analyze information (including design)

Tasks may include supplemental materials to facilitate the application of knowledge. Examples of supplemental materials that may be included are charts, tables, models, objects for classification, and animation clips.

When animation clips are needed, they will be provided for specific grades. Once a test administrator at grades 4, 7, or 11 has completed the AT Training and corresponding quiz, a link will appear in the OTS called “My AT Science Videos,” enabling access to the grade-appropriate videos. The video clips will be accessible directly on a computer, tablet or interactive white board with internet connectivity; **DO NOT DOWNLOAD** these videos as they are secure test materials. Additionally, a thumb drive will be included in the testing materials provided during shipping. **At the end of each testing window, the thumb drive (USB drive) must be returned to the District Assessment Coordinator (DAC) for return to the Kentucky Department of Education.** For students with visual impairments, **some** animation clips will be provided, in part, as tactile graphics. Each animation clip will have a scripted description of what is occurring in the clip; for students with visual impairments or other difficulty following animation clips. Please read the script exactly as written and provide any accompanying tactile graphic. The scripts **must** be read as written.

Students should be familiar with (and have available to them for use) appropriate grade level science tools which are needed for scientific inquiry and used in experiments; this includes, but is not limited to: ruler, scale, magnifying glass, magnet, clock, periodic table (as indicated by grade).

For the **Engineering and Technology** progression, it is important to focus on teaching students how to identify: a problem (e.g., the pencil keeps rolling off of the desk), what constraints (limits) the student has for fixing the problem (e.g., time, money, materials) and then given the constraints, deciding what the best solution to the problem is (e.g., put a book on the desk to stop the pencil, or place something under the short leg of the desk to make the desk level). This progression is about everyday problem solving that involves asking and answering questions:

1. What is wrong (or what is the problem)?
2. How can the problem be fixed?
3. What is needed to fix the problem (or for the solution)?
4. Is there enough time, money, space, materials, etc. to use this solution?
5. What else could be done?
6. How are society and the environment impacted?

Identifying problems and working through how different constraints will impact possible solutions is a very important life lesson.

High School

A full-color copy of the periodic table that will be used during the assessment is included (Figure 1) in this resource guide for instructional purposes.

For instructional purposes, it may be helpful to use the color-coding on the Periodic Table. When utilizing the periodic table, students should understand it is likely that Non-metals will react with other Non-metals and likely that Non-metals will react with Metals. Generally speaking, Noble Gases are non-reactive; meaning they do not easily combine with other elements to form compound elements.

Glossary of Science Terms

A picture glossary of science terms that may be used in the Attainment Tasks follows on pages 29-33.

1 H																	18 He
3 Li	2 Be															9 F	10 Ne
11 Na	12 Mg													15 P	16 S	17 Cl	18 Ar
19 K	20 Ca	21 Sc	22 Ti	23 V	24 Cr	25 Mn	26 Fe	27 Co	28 Ni	29 Cu	30 Zn	31 Ga	32 Ge	33 As	34 Se	35 Br	36 Kr
37 Rb	38 Sr	39 Y	40 Zr	41 Nb	42 Mo	43 Tc	44 Ru	45 Rh	46 Pd	47 Ag	48 Cd	49 In	50 Sn	51 Sb	52 Te	53 I	54 Xe
55 Cs	56 Ba	*	72 Hf	73 Ta	74 W	75 Re	76 Os	77 Ir	78 Pt	79 Au	80 Hg	81 Tl	82 Pb	83 Bi	84 Po	85 At	86 Rn
87 Fr	88 Ra	**	104 Rf	105 Db	106 Sg	107 Bh	108 Hs	109 Mt	110 Ds	111 Rg	112 Uub	113 Uut	114 Uuq	115 Uup	-	-	-
<div style="display: flex; justify-content: center; gap: 10px;"> <div style="background-color: lightblue; width: 20px; height: 10px; display: inline-block;"></div> Metals</div> <div style="background-color: red; width: 20px; height: 10px; display: inline-block;"></div> Non-Metals																	

Science

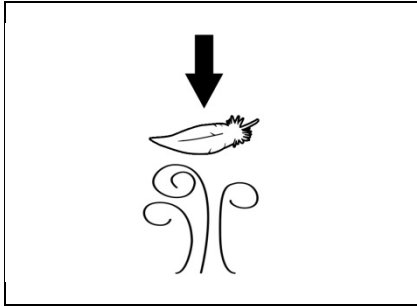

Air resistance

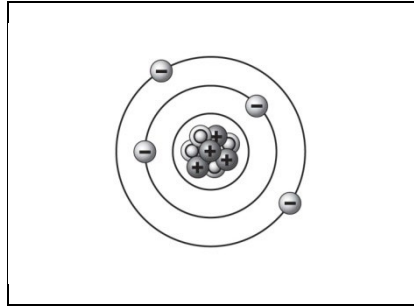

Atoms

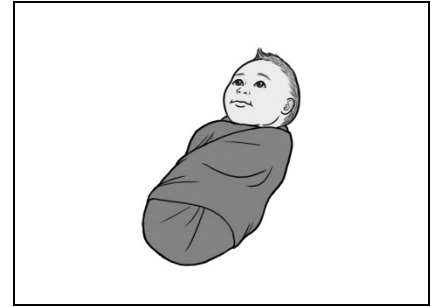

Birth

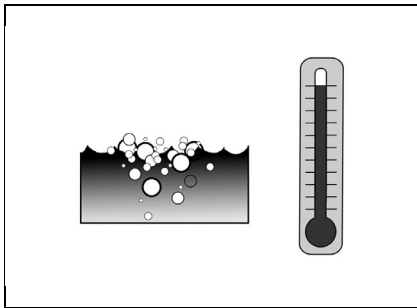

Boiling point

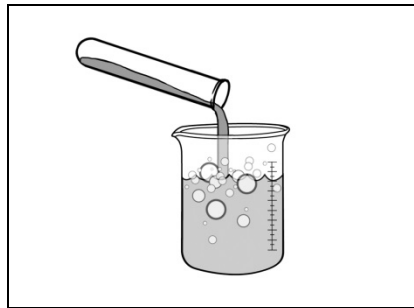

Chemical change

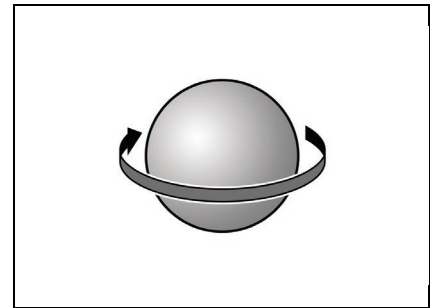

Circumference

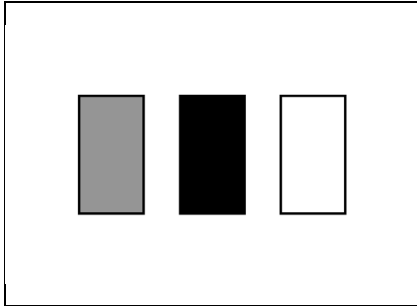

Color (property)

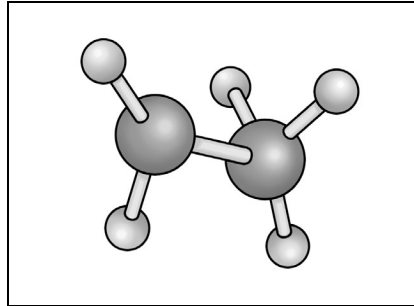

Compound

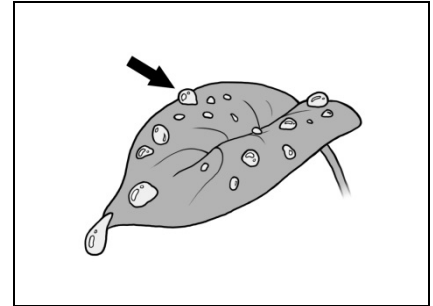

Condensation



Death

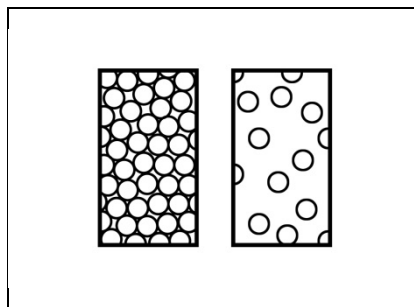

Density

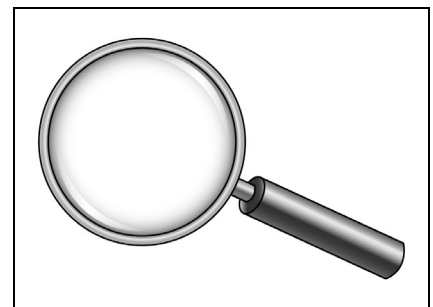

Detail, Find,
Investigation

Depictions in assessments may vary.

Science

Legend:
 ■ Metals
 □ Non-Metals
 □ Noble Gases

H	He																
Li	Be	B	C	N	O	F	Ne										
Na	Mg	Al	Si	P	S	Cl	Ar										
K	Ca	Sc	Ti	V	Cr	Mn	Fe	Co	Ni	Cu	Zn	Ga	Ge	As	Se	Br	Kr
Rb	Sr	Y	Zr	Nb	Mo	Tc	Ru	Rh	Pd	Ag	Cd	In	Sn	Sb	Te	I	Xe
Cs	Ba	Hf	Ta	W	Re	Os	Ir	Pt	Au	Hg	Tl	Pb	Bi	Po	At	Rn	
Fr	Ra	Rf	Db	Sg	Bh	Hs	Mt	Ds	Rg	Uu	Uu	Uu	Uu	Uu	Uu	Uu	Uu
La	Ce	Pr	Nd	Pm	Sm	Eu	Gd	Tb	Dy	Ho	Er	Tm	Yb	Lu			
Ac	Th	Pa	U	Np	Pu	Am	Cm	Bk	Cf	Es	Fm	Md	No	Lr			

Element (periodic table)

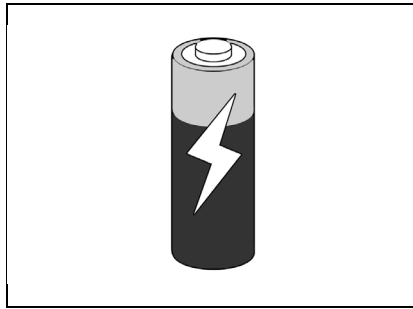

Energy

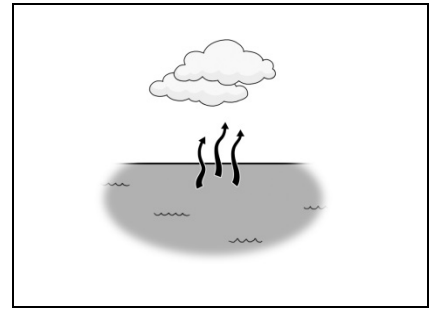

Evaporation

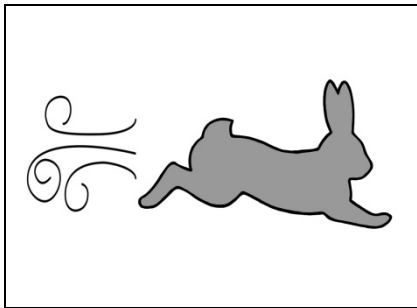

Fast

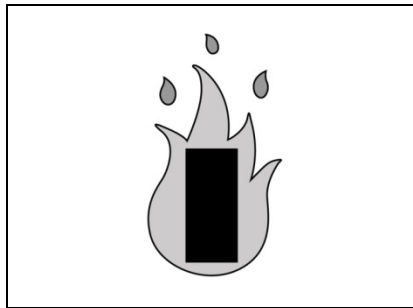

Flammability

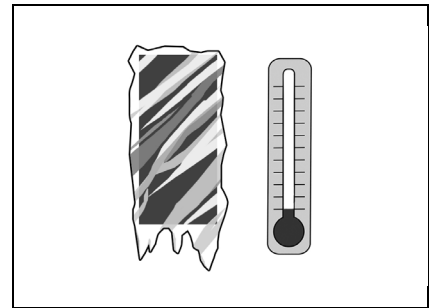

Freezing point

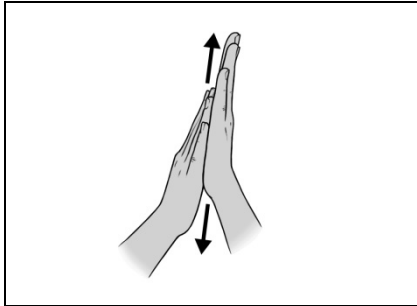

Friction

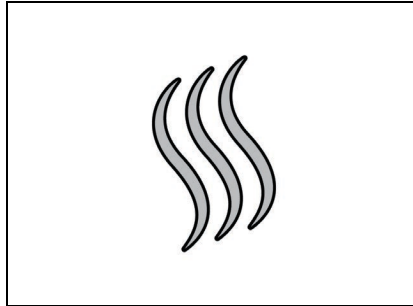

Gas

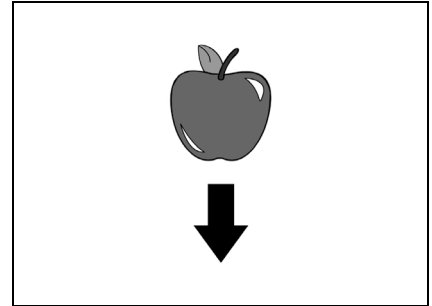

Gravity

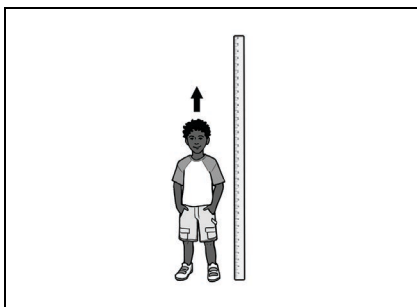

Growth

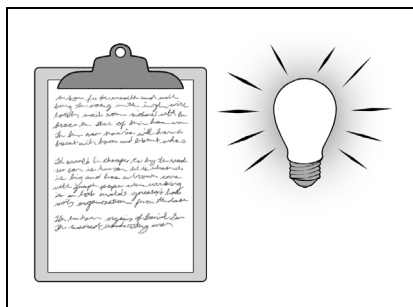

Hypothesis

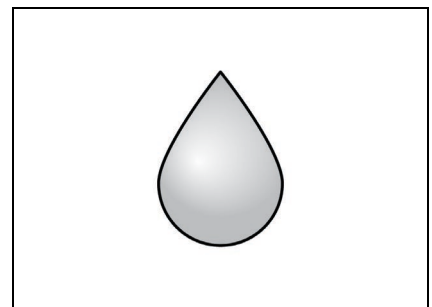

Liquid

Depictions in assessments may vary.

Science

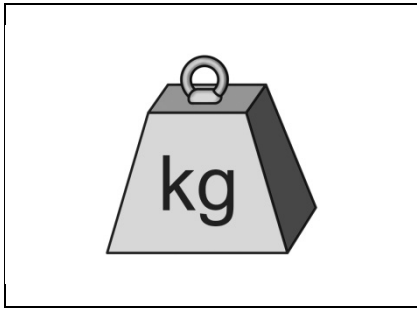

Mass

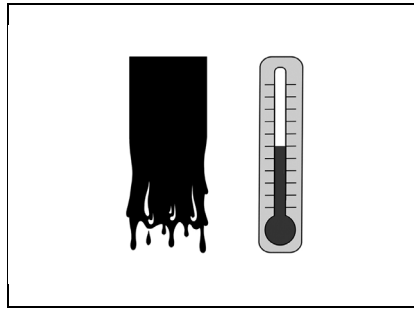

Melting point

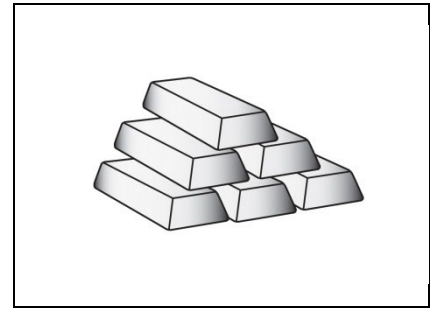

Metal

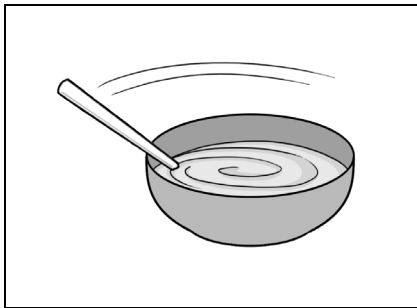

Mixture

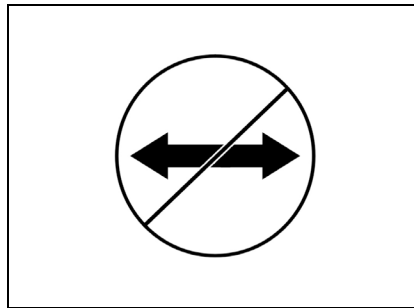

No Relationship

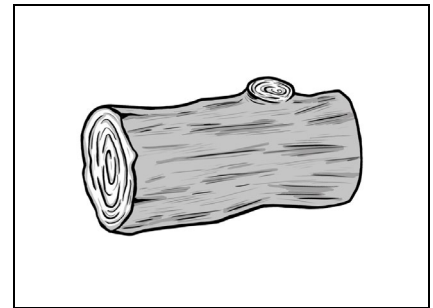

Nonmetal

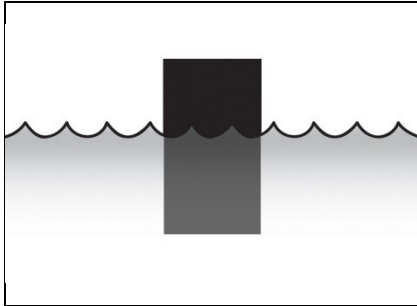

Non-reactive

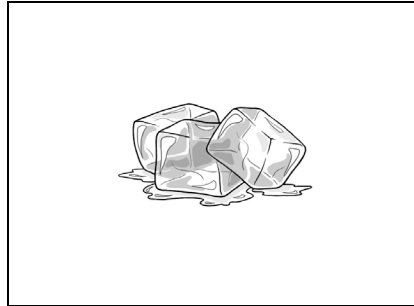

Physical change

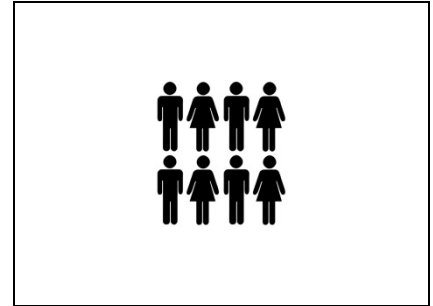

Population

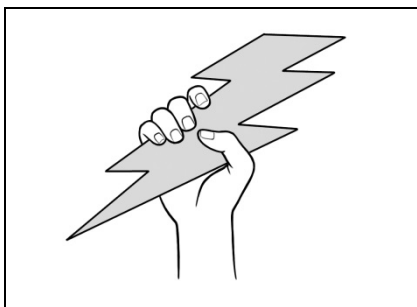

Power



Precipitation

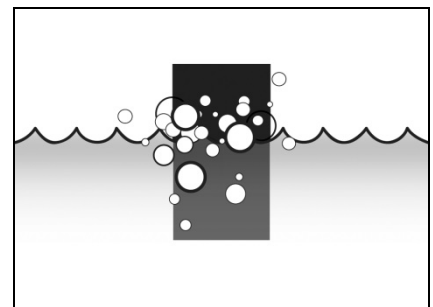

Reactivity

Depictions in assessments may vary.

Science



Reproduction

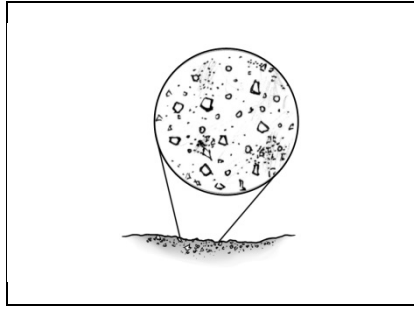

Sediment

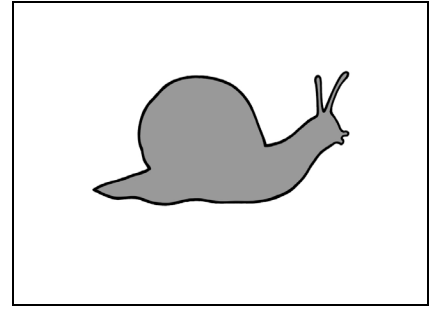

Slow

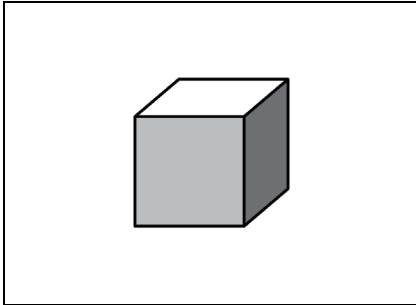

Solid

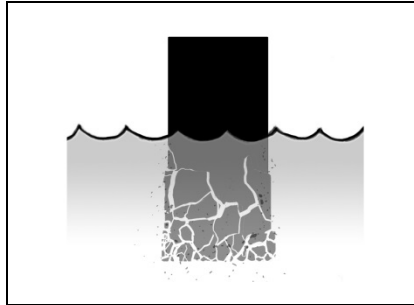

Solubility

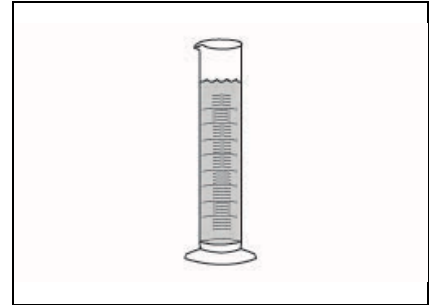

Volume

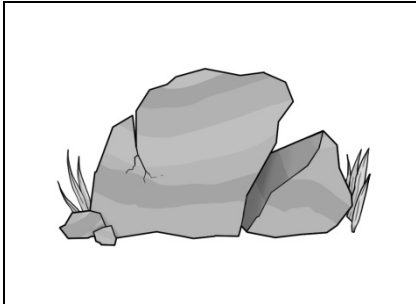

Weathering

Depictions in assessments may vary.

SOCIAL STUDIES

In Social Studies, students will often have supplemental materials to support the questions being asked in the Attainment Tasks. Depending on the grade level or the content standard, students will be provided with maps, short reading passages, and/or tables and charts.

Social studies is a complex integration of content standards and inquiry practices in regards to specific phenomena. Social studies goes beyond the acquisition of discrete skills and knowledge across the four domains of history, civics, geography and economics. Students must use the four inquiry practices of communicating claims, questioning, using evidence and investigating using disciplinary concepts to evaluate phenomena. Students must investigate the interrelatedness of factors of all domains for a complete understanding of the phenomena. For instance, when considering the historical impact of war, one must also consider the geographical features of the area (geography), the role of the government of the nations involved in that war (civics), and the financial implications (economics).

Glossary of Social Studies Terms

A picture glossary of social studies terms that may be used in the Attainment Tasks follows on pages 35-41.

Social Studies

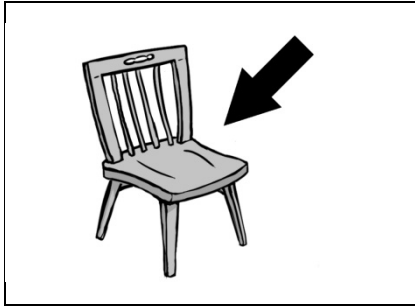

Appointment

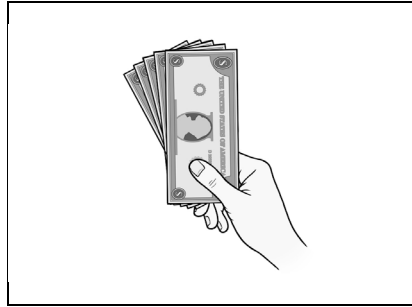

Bought, Paid, Demand
(as in supply and demand)

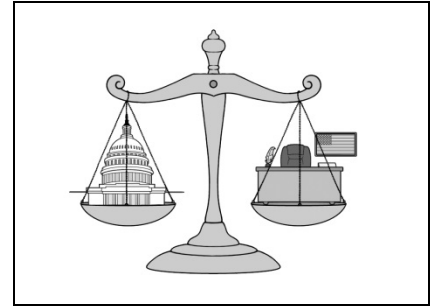

Checks and balances
(e.g., Federal)

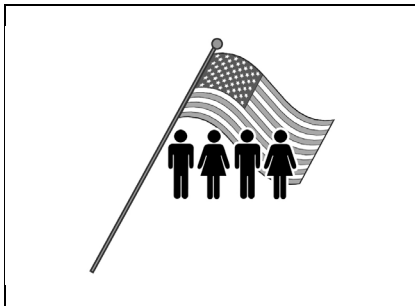

Citizen(s)

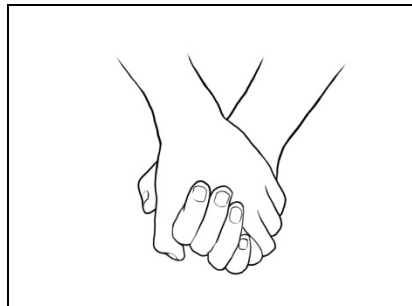

Collaboration, Friendship

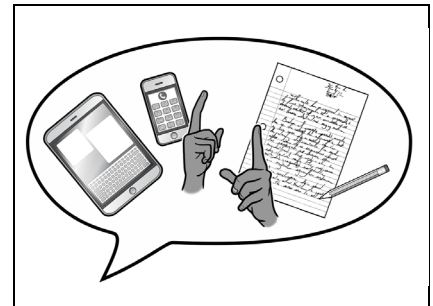

Communicate

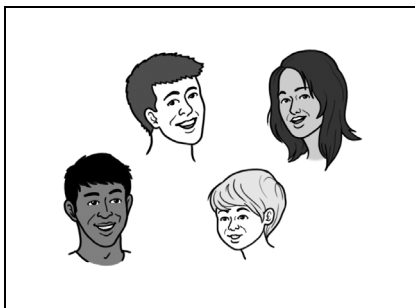

Community

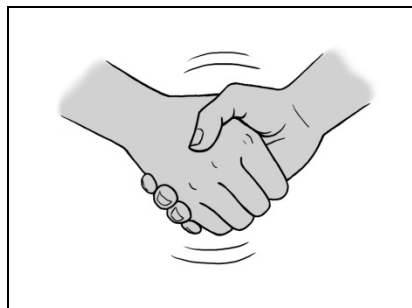

Compromise, Agree, Thank

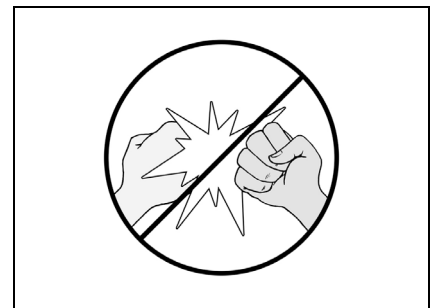

Conflict resolution

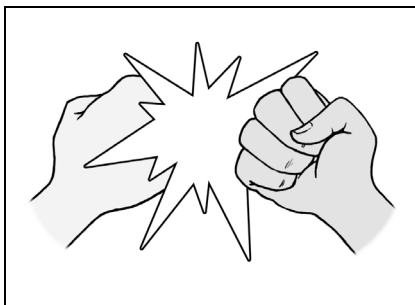

Conflict, Fighting

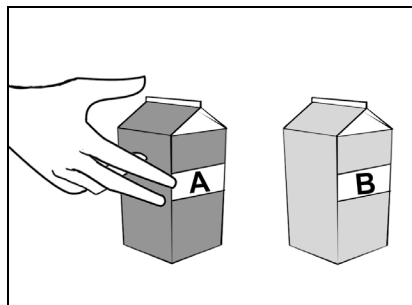

Consumer preference

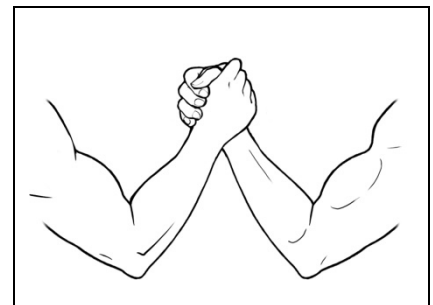

Contest

Depictions in assessments may vary.

Social Studies

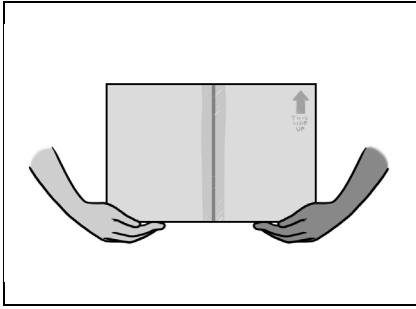

Cooperate

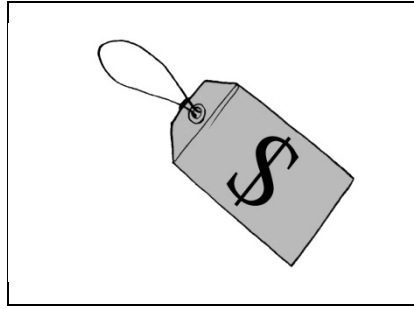

Cost, Price, Expense

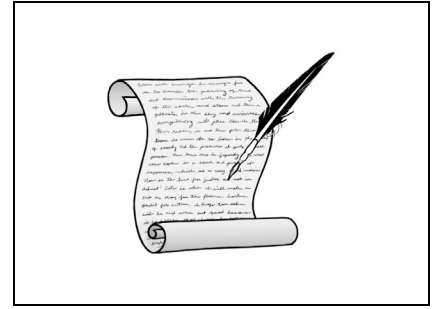

Create laws



Crime



Crime

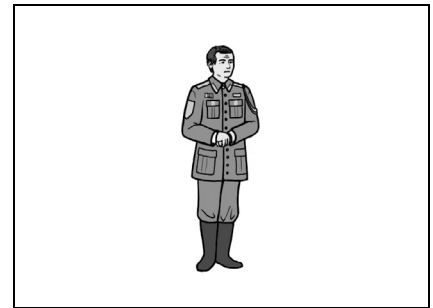

Dictator

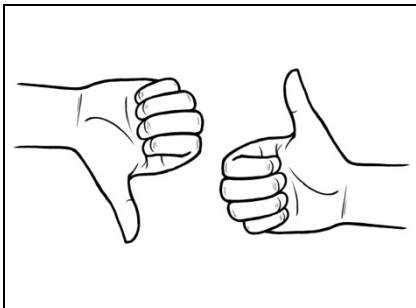

Disagreement, Differences

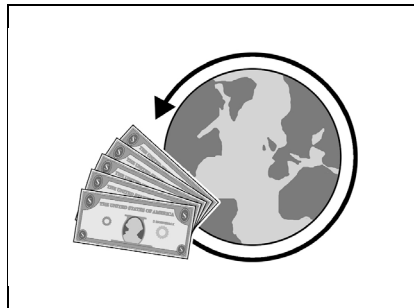

Economic globalization

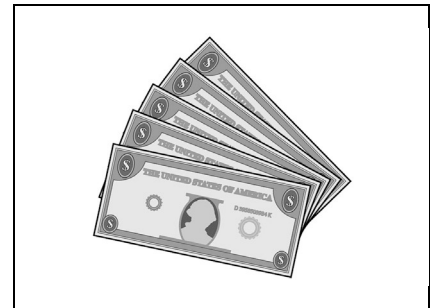

Economy

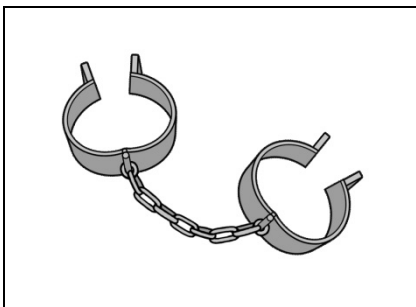

Emancipation

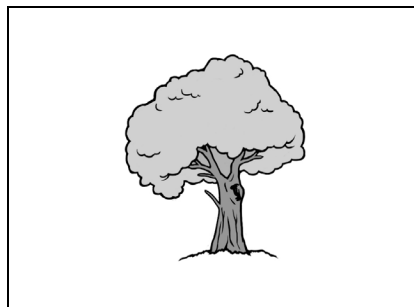

Environment

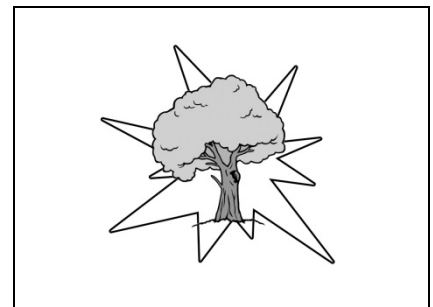

Environmental impact

Depictions in assessments may vary.

Social Studies

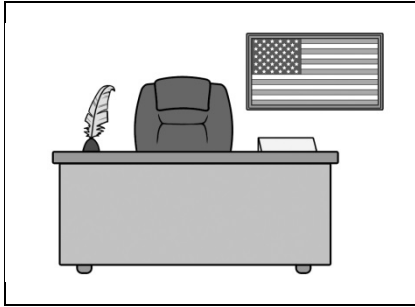

Executive branch
(example - Federal), President

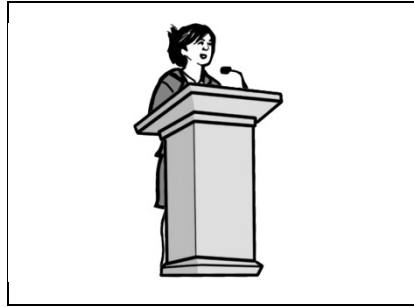

Free Speech

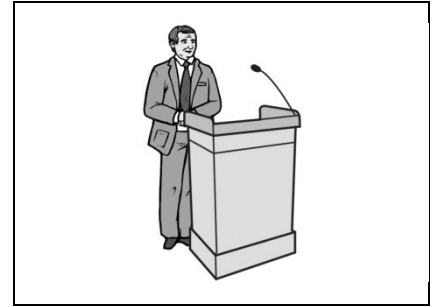

Governor

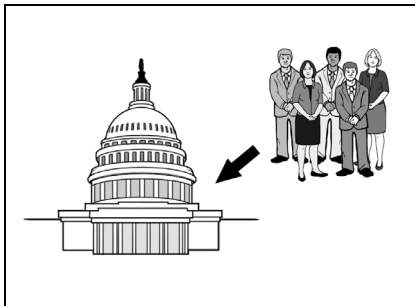

House of representatives
(example - Federal)



Immigration
(e.g., to Brazil)

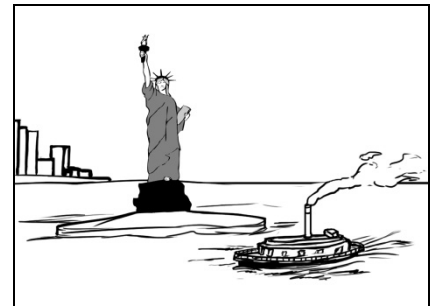

Immigration

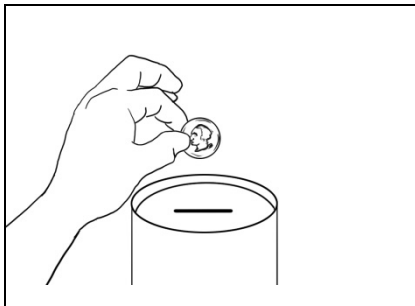

Input costs

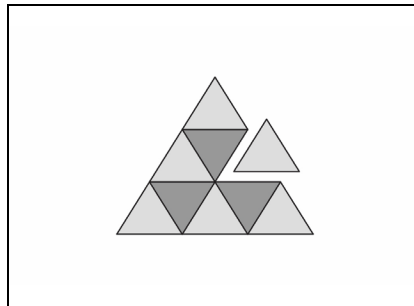

Integration



Judge, Justice, Supreme Court,
Decide if it is legal



Judicial branch, Supreme
Punishment

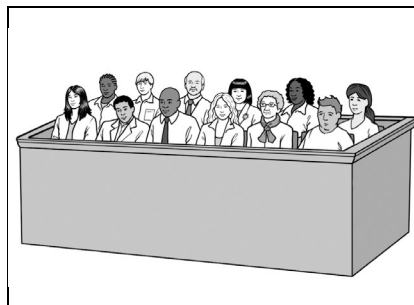

Jury

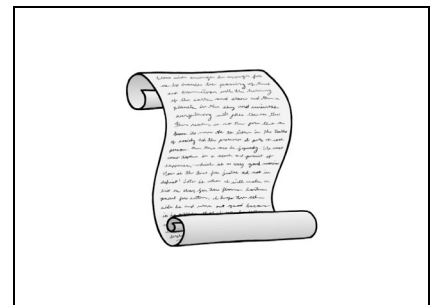

Law, Bill, Constitution,
Declaration of Independence

Depictions in assessments may vary.

Social Studies

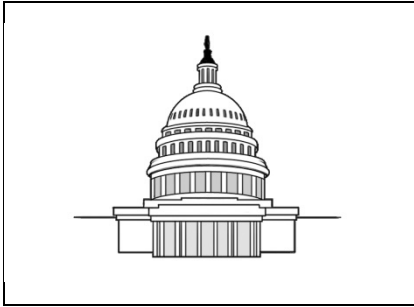

Legislative branch
(example - Federal)

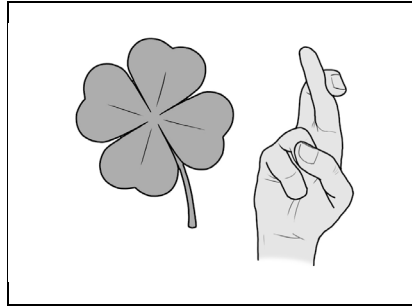

Luck, Four-leaf clover,
Crossed fingers



Monarchy

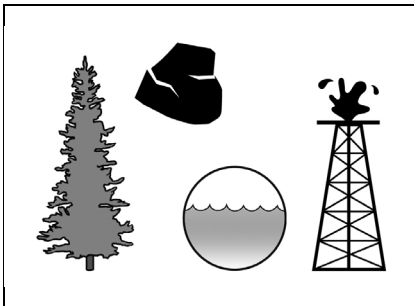

Natural Resources

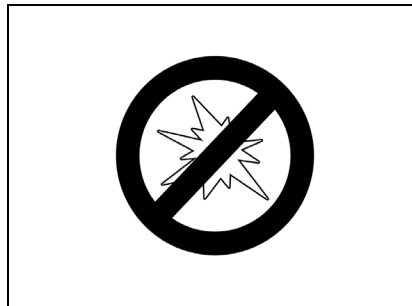

No impact



Obey the law, Enforce law or
legislation (may or may not
car in the background)

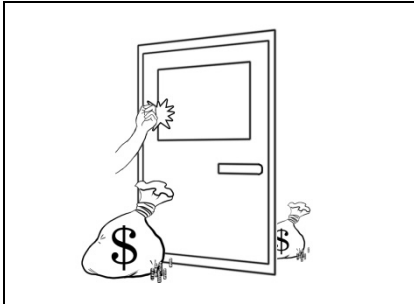

Opportunity cost

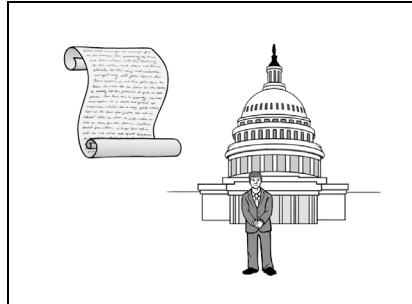

Passing law
(e.g., federal)

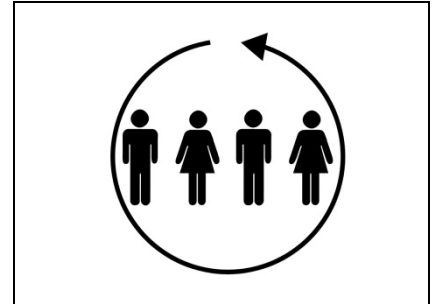

People as a whole



Picking up trash, Community
service

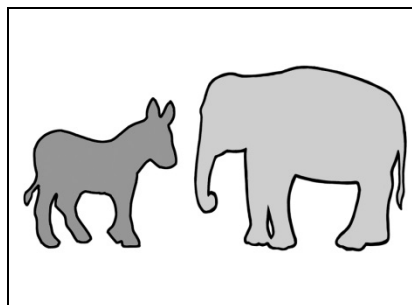

Political parties

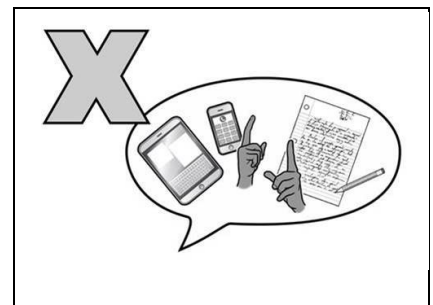

Poor communication

Depictions in assessments may vary.

Social Studies

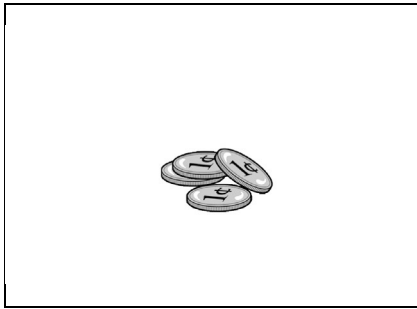

Poverty

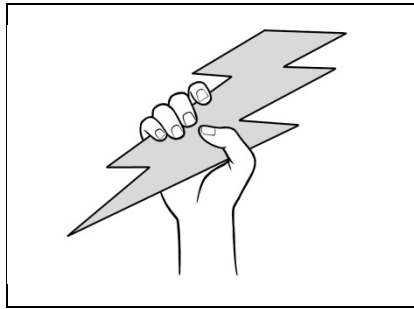

Power



Profit



Prohibition

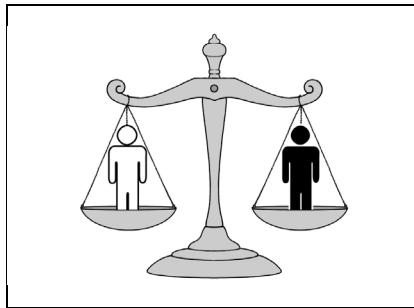

Racial equality



Registering for the military

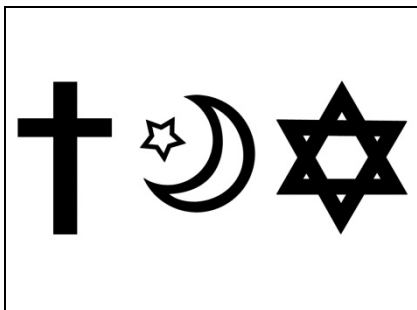

Religion

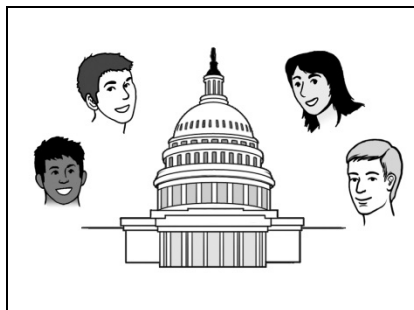

Representative government

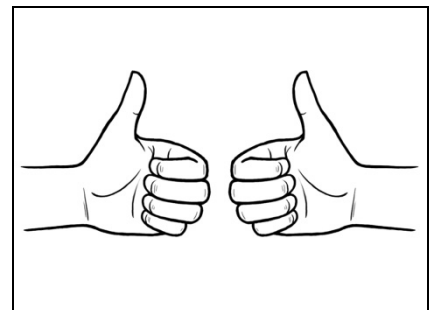

Resolution

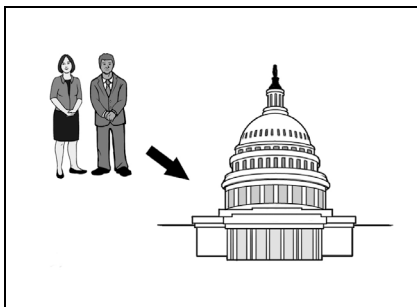

Senate, Senators
(e.g., Federal)

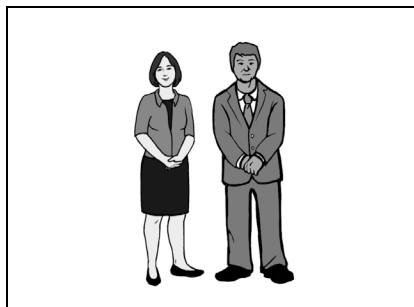

Senators, Representatives

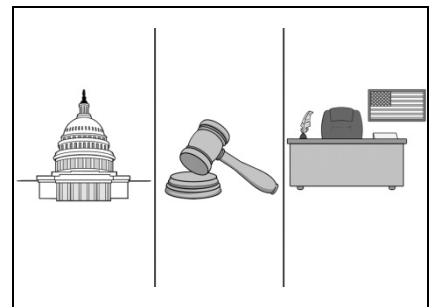

Separate power,
Separation of powers

Depictions in assessments may vary.

Social Studies

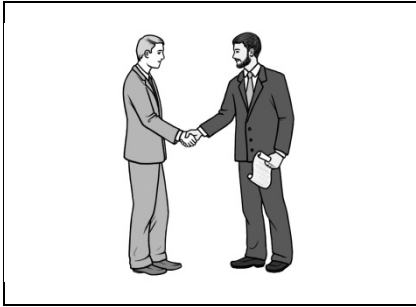

Settle disagreements

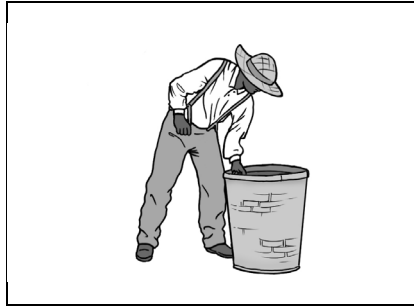

Slavery

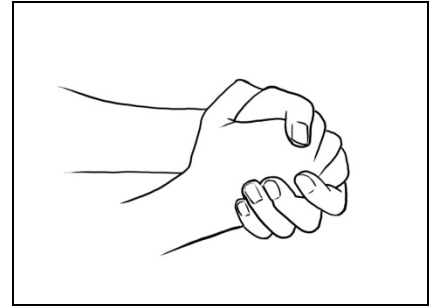

Sorry, Plead

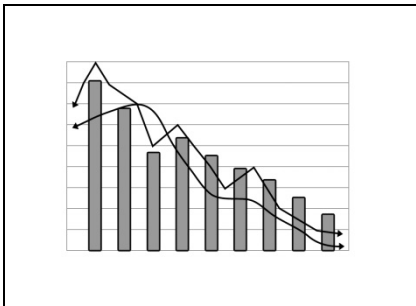

Stock market crash,
Poor economy

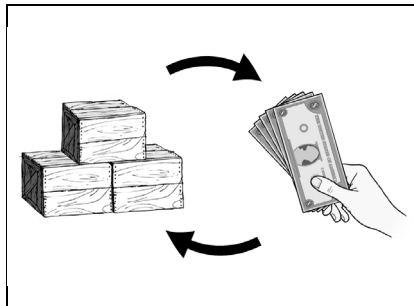

Supply and demand

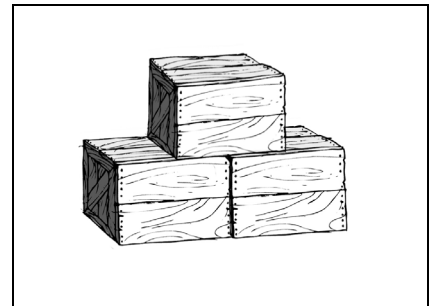

Supply

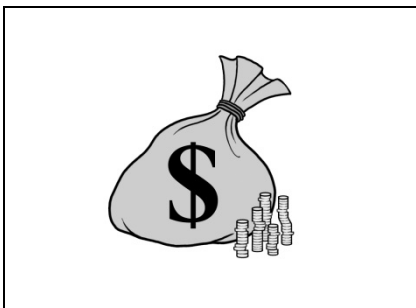

Tax

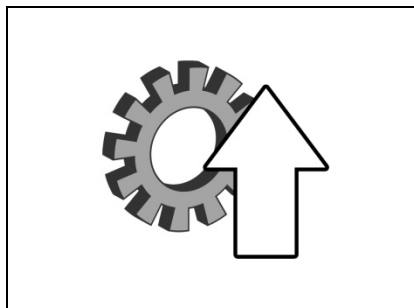

Technology advance

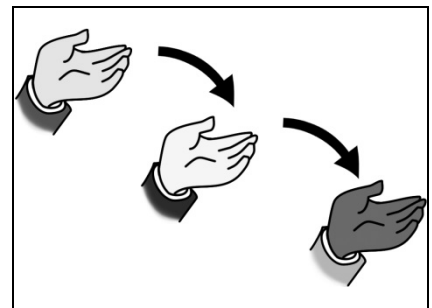

Tradition

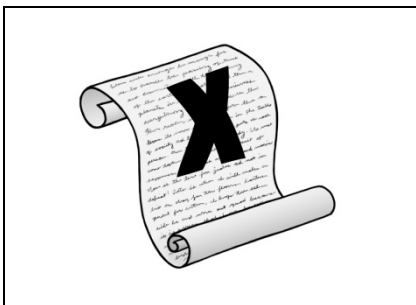

Veto bill

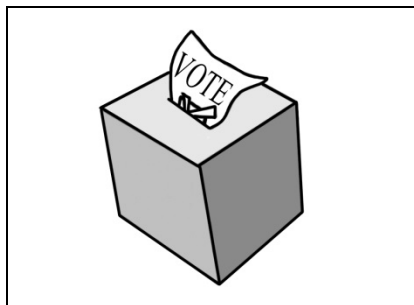

Voting

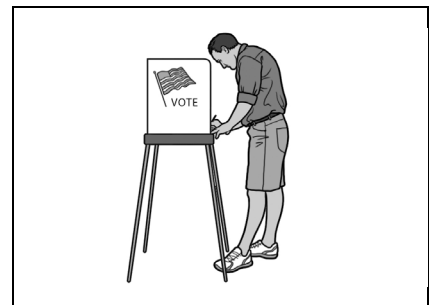

Voting

Depictions in assessments may vary.

Social Studies

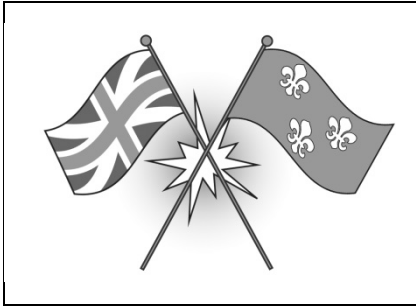

War (British v French)

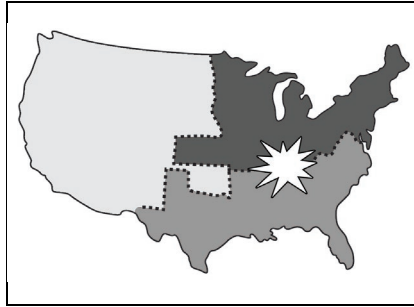

War (Civil War)

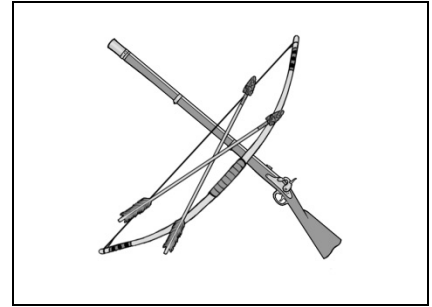

War (French and Indian)

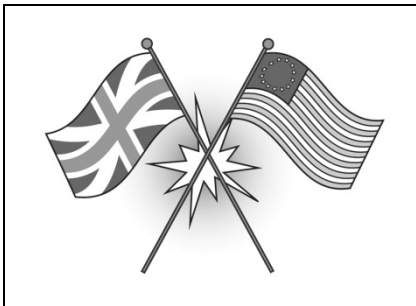

War (Revolutionary)

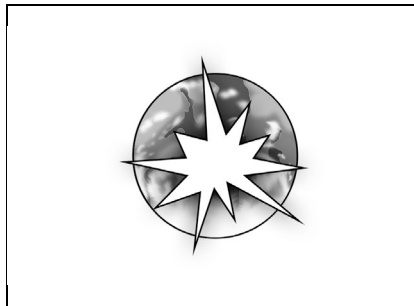

War (WWII)

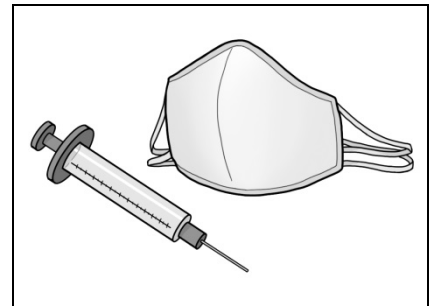

Widespread disease

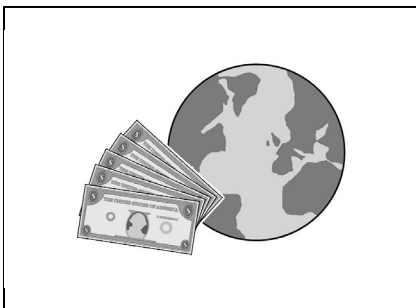

World economy

Depictions in assessments may vary.